

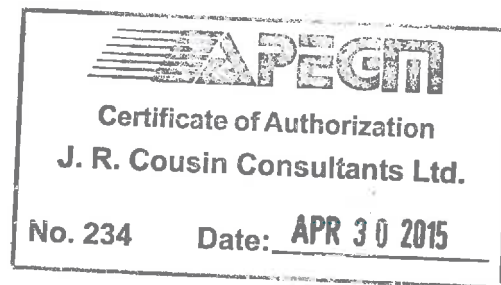

CITY OF DAUPHIN
Environment Act Proposal
For the
Waste Disposal Ground Upgrade and Expansion

Prepared by:

Oswald Wohigemut, M.Sc.
Environmental Scientist



Reviewed by:

Jeff Dyck, P.Eng.
Senior Municipal Engineer

April 2015

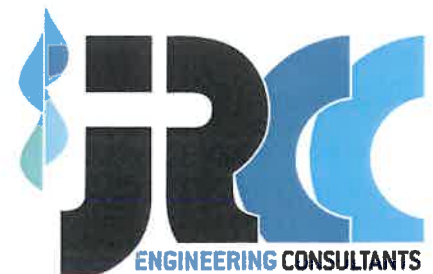

ACKNOWLEDGMENTS

To prepare this report various sources of information were investigated and researched. JR Cousin Consultants Ltd. (JRCC) wishes to thank the City of Dauphin who contributed to the data and content of this report. In addition, we wish to commend the City of Dauphin officials for their fortitude in addressing the need for a long-term solution to solid waste disposal for the residents of the City of Dauphin and the RM of Dauphin.

REMARKS

JR Cousin Consultants Ltd. has conducted this environment act proposal in accordance with generally accepted professional engineering principles and practices for the purpose of identifying conditions that may have an environmental impact on the site. The findings and recommendations reached in this report are based on information made available to JRCC during the investigation and conditions at the time of the site investigation. Conclusions derived in this report are intended to reduce, but not wholly eliminate the uncertainty regarding potential environmental concerns on the site, and recognizes reasonable limitations with regards to time, accuracy, work scope and cost. It is possible that environmental conditions may change from the date of this report. If conditions appear different from those encountered and expressed in this report, JRCC should be informed so that mitigation recommendations can be reviewed and adjusted as required. Historical data and information obtained from personal communication used in this report, are assumed to be correct, however JRCC has not conducted further investigations into the accuracy of this data. JRCC has produced this report for the use of the client, and takes no responsibility for any third party decisions or actions based on information contained in this report.

TABLE OF CONTENTS

Section	Page of Section
ENVIRONMENT ACT PROPOSAL FORM	i
EXECUTIVE SUMMARY	1
1.0 INTRODUCTION AND BACKGROUND	1
1.1 Introduction	1
1.2 Contact Information	1
1.3 Background Information	1
1.4 Description of Previous Studies	1
1.5 Project Description	2
2.0 DESCRIPTION OF THE DEVELOPMENT	1
2.1 Land Title/Location	1
2.2 Owner of Land and Mineral Rights	1
2.3 Existing Land Use	1
2.4 Land Use Designation/Zoning Designation	2
2.5 Description of Development	2
2.5.1 Project Schedule	2
2.5.2 Basis for Proposed WDG Upgrade and Expansion Site Selection	2
2.5.3 Siting Concerns	3
2.5.4 Projected Service Population	4
2.5.4.1 City of Dauphin	4
2.5.4.2 RM of Dauphin	4
2.5.4.3 Other Contributing Populations	4
2.5.4.4 Population Summary Table	5
2.5.5 Projected Waste Generation	5
2.5.5.1 Waste Generation	5
2.5.5.2 Recycling	6
2.5.5.3 Compost	6
2.5.5.4 City of Dauphin	7
2.5.5.5 RM of Dauphin	7
2.5.5.6 Waste Generation Summary Table	7
2.5.6 Topography and Geotechnical Review	8
2.5.6.1 Past Geotechnical Investigations	8
2.5.6.2 Onsite Geotechnical Investigation	9
2.5.6.3 Topography	12
2.5.6.4 Groundwater Elevation and Flow Direction	12
2.5.7 WDG Cell Liner Requirements	13
2.5.8 Contaminant Migration	14
2.5.9 Conceptual Design	15
2.5.9.1 Proposed Development	15
2.5.9.2 Storage Requirements	15
2.5.9.3 Conceptual Liner Design	16
2.5.9.4 Monitoring Wells	16

Section	Page of Section
2.5.9.5	Cover System 17
2.5.9.6	Cell Closure 17
2.5.9.7	Leachate Management System..... 17
2.5.9.8	Compost Area 18
2.5.9.9	Drainage..... 18
2.5.9.10	Access Road 19
2.5.9.11	Fencing and Signage..... 19
2.5.10	Construction Techniques..... 19
2.5.11	Decommissioning and Closure 20
2.5.12	WDG Maintenance and Operation..... 20
2.5.12.1	General Site Operation and Maintenance..... 20
2.5.12.2	Compost Operation and Maintenance 21
3.0	POTENTIAL ENVIRONMENTAL IMPACTS 1
3.1	Releases to Air, Water, Land 1
3.1.1	Air..... 1
3.1.2	Water 1
3.1.3	Land 1
3.2	Wildlife 2
3.3	Fisheries..... 2
3.4	Forestry..... 3
3.5	Vegetation..... 3
3.6	Noise Impacts 3
3.7	Health and Safety 3
3.8	Heritage Resources..... 3
3.9	Socio-Economic Implications 4
3.10	Aesthetics 4
4.0	MANAGEMENT PRACTICE 1
4.1	Mitigation of Impacts to Air 1
4.2	Mitigation of Impacts to Water 1
4.3	Mitigation of Impacts to Land..... 2
4.4	Mitigation of Impacts to Vegetation 2
4.5	Mitigation of Noise Impacts 2
4.6	Mitigation of Impacts to Health and Safety..... 2
4.7	Mitigation of Impacts to Heritage Resources 3
4.8	Aesthetics 3
5.0	RESIDUAL AND CUMULATIVE EFFECTS 1
6.0	MONITORING AND FOLLOW-UP 1
7.0	FUNDING AND APPROVALS 1
8.0	PUBLIC CONSULTATION 1
9.0	CONCLUSION 1

Appendix A

Certificate of Title

Crown Lands & Property Agency - Lands Branch, March 11, 2015 Email Correspondence

Appendix B

Table 1: Population and Waste Generation Projections – City of Dauphin Waste Disposal Ground

Manitoba Conservation and Water Stewardship - Wildlife and Ecosystem Protection Branch, March 23, 2015
Email Correspondence

Manitoba Tourism, Culture, Heritage, Sport and Consumer Protection - Historic Resources Branch, April 4, 2015
Memorandum

Appendix C

Test Hole Logs

Stantec Consulting Ltd. Soils Analysis Report, August 26, 2014

Stantec Consulting Ltd. Soils Analysis Report, October 6, 2014

Driller's Well Logs

Appendix D

Title Page

Plan 1: Site Location Plan with Required Setbacks and Drainage Route

Plan 2: WDG Upgrade and Expansion Site with Test hole Location Plan

Plan 3: Proposed Expansion and Upgrade Layout and Drainage Plan

Plan 4: Dike and Liner Details

Plan 5: Road, Ditch, Fence, Sten Log and Sign Details

Environment Act Proposal Form



Name of the development: Dauphin Waste Disposal Ground Upgrade/Expansion	
Type of development per Classes of Development Regulation (Manitoba Regulation 164/88): Class 1	
Legal name of the applicant: City of Dauphin	
Mailing address of the applicant: 100 Main Street South	
Contact Person: Mr. Bill Brenner	
City: Dauphin	Province: Manitoba Postal Code: R7N 1K3
Phone Number: (204) 622-3212	Fax: (204) 622-3291 email: bbrenner@dauphin.ca
Location of the development: City of Dauphin	
Contact Person: Mr. Bill Brenner	
Street Address:	
Legal Description: SW 20-25-19 WPM	
City/Town: City of Dauphin	Province: Manitoba Postal Code: R7N 1K3
Phone Number: (204) 622-3212	Fax: (204) 622-3291 email: bbrenner@dauphin.ca
Name of proponent contact person for purposes of the environmental assessment: Jeff Dyck, JR Cousin Consultants Ltd.	
Phone: 204-489-0474	Mailing address: 91 A Scurfield Blvd
Fax: 204-489-0487	Winnipeg, Manitoba
R3Y1G4	
Email address: jdyck@jrcc.ca	
Webpage address: www.jrcc.ca	
Date: 2015 / 04 / 30	Signature of proponent, or corporate principal of corporate proponent: 
	Printed name: Jeff Dyck

EXECUTIVE SUMMARY

General

The City of Dauphin is proposing to construct an upgrade and expansion to the existing Class I Waste Disposal Ground located at SW 20-25-19 WPM in the RM of Dauphin, Manitoba. An Environment Act Licence will be required from Manitoba Conservation for the expansion/upgrade and continued operation of the waste disposal ground (WDG). JR Cousin Consultants Ltd. (JRCC) was retained for the engineering services.

Description

The proposed expansion and upgrade of the existing Dauphin WDG would continue to service residents throughout the City and RM of Dauphin. Rural residents in the RM currently utilize the WDG by individual drop off, while the City has a curbside waste collection and recycling program. The WDG expansion would include constructing five separate waste disposal cells over a design period of 25 years, while the upgrade would include a compost area, a compost leachate retention pond, and associated ditching, fencing and access roads to the east and south of the existing waste disposal cells at the site.

The existing WDG and proposed expansion area is located approximately 2 km northwest of the City of Dauphin, Manitoba. The expansion area is located on cleared grassland, with Municipal Road 147 N bordering the site to the south and a CN Railway Line bordering the site to the north and east. The existing waste disposal cells are located to the west of the expansion area.

Population and Waste Generation

The projected year 25 service population using the Dauphin WDG would include residents in the RM of Dauphin and the City of Dauphin, which includes the residential, commercial and institutional populations. The year 25 design population for the RM was estimated to be 2,200 people, while the population for the City was estimated to be 10,516 people, with an additional 180 people from the correctional facility, for a total year 25 service population of 12,896 people. Based on an average waste generation rate of 1.68 kg/person/day for the population in the City of Dauphin and correctional facility and 0.51 kg/person/day for the rural residents in the RM of Dauphin, the total annual waste generation rate in design year 25 was estimated to be 14,670 m³/year.

Topographical Survey and Geotechnical Investigation

The land surrounding the existing waste disposal cells to the east, southeast and south was investigated for the location of the potential upgrade and expansion cells. The general soil profile consisted of surficial black topsoil followed by layers of fine grain sand and silt to depths of 0.9 m – 1.4 m below the surface, followed by alternating layers of low plastic sandy clay, low plastic silt till and sandy till down to the bottom of the test holes at 5.0 m below the surface. These layers were not consistently found in the same order in each of the test holes or with the same thickness throughout the expansion area. In addition, TH5 consisted of alternating layers of sand and silt till, with no layer of clay till observed. Bedrock was not encountered. Water infiltration was observed at depths of 1.2 m to 2.6 m below the surface, while the short-term static water level was recorded at depths of 3.8 m to 4.9 m below the surface.

The layer of sandy clay material found on the site was reworked and tested for permeability. Based on the laboratory analysis, this material achieved hydraulic conductivity values of 1.3×10^{-8} cm/sec (TH2) and

2.8×10^{-8} cm/sec (TH7). The requirements for a clay waste disposal cell liner, according to Manitoba Conservation, are a minimum 1.0 m thick clay liner achieving a consistent hydraulic conductivity of 1×10^{-7} cm/sec or less.

Liner Construction

The results of the reworked permeability testing indicated that the sandy clay material at the site can be reworked and used for constructing a cell liner for the expansion cells, compost area and leachate retention pond. Therefore, the cell liners will consist of vertical cut-off walls and horizontal liners constructed with reworked sandy clay soils from the cell excavation.

1.0 INTRODUCTION AND BACKGROUND

The development described herein is for construction of new waste disposal expansion cells, compost area and compost leachate retention pond at the Dauphin WDG, in the RM of Dauphin, Manitoba.

1.1 Introduction

The City of Dauphin is proposing the upgrading and expansion of the existing Class I Waste Disposal Ground (WDG) located at SW 20-25-19 WPM in the RM of Dauphin, Manitoba. The conceptual design of the WDG upgrade and expansion would be based upon a projected year 25 service population for residents in the City of Dauphin and the RM of Dauphin. An Environment Act Licence is required from Manitoba Conservation for the construction and continued operation of the upgraded and expanded facility. JR Cousin Consultants Ltd. (JRCC) was retained for the engineering services.

1.2 Contact Information

Mr. Jeff Dyck, P.Eng.
JR Cousin Consultants Ltd.
91A Scurfield Blvd.
Winnipeg, Manitoba
R3Y 1G4
Phone (204) 489-0474, Fax (204) 489-0487

Mr. Bill Brenner, CET
City of Dauphin
100 Main St. South
Dauphin, MB
R7N 1K3
Phone (204) 622-3212, Fax (204) 622-3291

1.3 Background Information

The City of Dauphin WDG is located approximately 2 km northwest of the City of Dauphin, Manitoba (see Plan 1 attached in Appendix D). The existing WDG is owned and operated by the City of Dauphin and services the residents in the City of Dauphin and the RM of Dauphin. A curbside waste and recycling program is being utilized in the City, while rural residents in the RM drop off waste individually. The site is located along Road 147 N, and a CN Railway Line, in the RM of Dauphin. The land surrounding the existing WDG is agricultural land.

1.4 Description of Previous Studies

The report entitled *City of Dauphin Waste Disposal Ground Upgrade and Expansion Preliminary Design Report*, by JRCC (February 2015) was reviewed to obtain background information on the proposed site of development. The report included an onsite topographic and geotechnical investigation for the upgrade and expansion areas.

1.5 Project Description

As requested by the City of Dauphin, the existing WDG site is in need of a properly designed compost storage pad and compost leachate retention pond, along with expansion waste disposal cells, in accordance with the current Operating Permit (No. 36036) and applicable provincial guidelines and regulations governing WDG sites. The site upgrade and expansion will be designed to handle the long-term waste generation from the service population in the city and RM, to design year 25.

2.0 DESCRIPTION OF THE DEVELOPMENT

For each heading there is an information request from the Environment Act Proposal Form. These requests are repeated herein in italics followed by the pertaining response.

2.1 Land Title/Location

Certificate of Title showing the owner(s) and legal description of the land upon which the development will be constructed; or, in the case of highways, rail lines, electrical transmission lines, or pipelines, a map or maps at a scale no less than 1:50,000 showing the location of the proposed development:

The existing WDG and proposed expansion site is located in SW 20-25-19 WPM, approximately 2 km northwest of the City of Dauphin, Manitoba. The expansion area is a cleared portion of grassland with a tree line along the border of the property. The lands surrounding the proposed expansion area are agricultural, with Municipal Road 147 N bordering the site to the south and a CN Railway Line bordering the site to the north and east. The land parcel is currently owned by the City of Dauphin under certificate of title number 124690 (attached in Appendix A).

2.2 Owner of Land and Mineral Rights

Owner of land upon which the development is intended to be constructed, and of mineral rights beneath the land, if different from surface owner:

The Crown Lands & Property Agency was contacted regarding the ownership of the mines and minerals at the proposed development location. According to the Crown Lands & Property Agency, the ownership of sand & gravel remains with the surface title (owned by the City of Dauphin), while the mines & minerals are owned by The Crown (Province of Manitoba) (see email correspondence from the Crown Lands & Property Agency in Appendix A).

2.3 Existing Land Use

Existing land use on the site and on land adjoining it, as well as changes that will be made in such land use for the purposes of the development:

The proposed expansion cells and compost leachate retention pond areas are cleared grassland with no dedicated land use. The location designated for the compost storage pad is on top of a decommissioned waste disposal cell, which has been capped and is covered with grass. The surrounding adjacent lands on the opposite side of Municipal Road 147 N and the CN Railway Line are agricultural and are currently being used as for crop production. The nearest residence is a farmyard located approximately 800 m to the southeast. The City residential outskirts are located approximately 3.9 km to the southeast of the WDG expansion area (see Plan 1 in Appendix D).

2.4 Land Use Designation/Zoning Designation

Land use designation for the site and adjoining land as identified in a development plan adopted under The Planning Act or The City of Winnipeg Act, and the zoning designation as identified in a zoning by-law, if applicable:

Based on information provided by the City, the WDG site is currently zoned as Agricultural General, with a condition for waste disposal grounds.

2.5 Description of Development

Description of proposed development and schedule for stages of the development, including proposed dates for planning, design, construction, commissioning, operation, and decommissioning and/or termination of operation (if known), identifying major components and activities of the development as applicable (e.g. access road, airstrip, processing facility, waste disposal area, etc.).

2.5.1 Project Schedule

The WDG upgrade and expansion design is proposed to begin upon receipt of an Environment Act Licence. The compost storage pad and compost leachate retention pond construction works are proposed to begin in the summer/fall of 2015, while the construction of new expansion cells is not expected for several years, due to existing capacity in the current waste disposal cells. Commissioning and operation of the compost pad and leachate pond are proposed to begin upon completion of construction and after approval for use is obtained from Manitoba Conservation. No date for decommissioning has been set for the WDG cells, however the expansion cells would be designed for a projected year 25 service population, and a WDG capacity assessment should be conducted as the WDG approaches this year 25 design life.

2.5.2 Basis for Proposed WDG Upgrade and Expansion Site Selection

The location for the WDG upgrade and expansion works was chosen based on discussions with the City of Dauphin and from a site investigation conducted by JRCC in July, 2014. The siting of the upgrade and expansion was considered based on availability of land and proximity to nearby rural residents, city residents and sensitive areas.

According to the *Guidelines for the Siting of a Class I Waste Disposal Ground in Manitoba* (1994), the siting of the WDG compost area, leachate pond and expansion cells would require the following provincial guidelines and minimum setback requirements:

- Watersheds with surface water flow through the site
- Sites underlain with sand, gravel, sandstone, limestone
- Sites on the edge of steep slopes, subject to erosion and land sliding
- Sites within 2 km of wetlands
- Bedrock outcrops
- Karst terrain

- Fractured bedrock
- Unstable terrain
- Areas of unpredictable geology
- Sites with shallow water tables or perched aquifers
- Groundwater pollution hazard areas
- Areas within 100 year flood plain
- Areas with limited access to roads or utilities
- Sites within 400 m of a residence
- Sites within 400 m of a potable water well
- Sites within 400 m of a cemetery
- Sites within 2 km of a critical habitat area
- Sites within 2 km of a designated park or historic site
- Sites within 100 m from a public road or railway right of way
- Sites within 1 km from a body of surface water
- Sites within 8 km of an airport or setback as described in the local zoning plan.

An important concern in evaluating Class I WDG sites is the protection of water quality, and human health and safety. The above siting requirements are established to ensure that if a WDG fails to adequately contain leachate, the site's natural conditions will protect groundwater and surface water resources, and control the migration of landfill gases. Preference should be given to sites located in areas where there is clay or till of low permeability (1×10^{-7} cm/sec or less) to ensure groundwater protection and minimal migration of landfill gases. If soils of sufficiently low permeability are not available, a geomembrane liner should be considered for containment.

2.5.3 Siting Concerns

Based on the proposed location of the Dauphin WDG upgrade and expansion, the concerns regarding siting include:

- Distance to surface water body – there is a third order provincial drain (Salt Creek) approximately 800 m from the proposed expansion area.
- Distance to public road or railway right of way – the proposed expansion cells and compost area are located within 100 m of Road 147 N, which is a public road adjacent to the WDG. The expansion cells would also be located within 100 m of the CN Railway line.
- Distance to nearest airport – the proposed expansion area is located approximately 7.5 km from the Dauphin Airport.

Variations for these setbacks are being requested from Manitoba Conservation by way of this EAP. Plan 1 in Appendix D, shows the minimum setback requirements as described above.

2.5.4 Projected Service Population

A review of the service population for the Dauphin WDG was conducted to assess the current and projected waste disposal requirements. The assessment was utilized to determine the sizing requirements for the proposed expansion cells, compost area and leachate retention pond at the waste disposal ground.

Population data was obtained from Statistics Canada and from discussions with the City of Dauphin. The service population utilizing the Dauphin WDG includes residents within the City and the surrounding RM. There were no major industrial contributors to the WDG site identified by the City.

2.5.4.1 City of Dauphin

Based on the latest census data from Statistics Canada (2011), the City population was 8,251 people. Based on a review of past census data for the city, over the past 15 years the population has remained relatively stable with a decline in population between 1996 and 2006, and growth between 2006 and 2011. From discussions with the City, the population is assumed to be growing slowly at a rate of approximately 0.87% annually, which matches the annual population growth from 2006 to 2011. This growth rate of 0.87% was utilized to project current and future populations to design year 25. The current population was estimated to be 8,468 people, and the projected year 25 population was estimated to be 10,516 people.

2.5.4.2 RM of Dauphin

Based on the latest census data from Statistics Canada (2011), the RM population was 2,200 people. Based on a review of past census data for the RM, over the past 15 years the population has declined overall, but has remained fairly stable over the last 10 years. Therefore, for design purposes the population growth is assumed to be 0%. Therefore the current and projected year 25 populations utilized for the RM are 2,200 people.

2.5.4.3 Other Contributing Populations

There is an existing correctional facility in the City of Dauphin that has a capacity for 50 people, plus staff, which would be considered an additional service population as individuals in the facility would not be considered as residents in the census data. From discussions with the City, there is a preliminary plan to construct a new correctional facility with a capacity of 180 people, plus staff, to replace the existing facility. Staff would be considered in the residential population, however the inmates would be considered additional to the service population. Therefore the service population from the correctional facility is estimated to increase from 50 to 180 people in design year 5 and be maintained until design year 25.

2.5.4.4 Population Summary Table

The current and projected populations for the service area have been included in the summary table below and in the attached Table 1 (Appendix B).

Contributing Population	2011 Population	Year 25 Population
City of Dauphin	8,251	10,516
RM of Dauphin	2,200	2,200
Correctional Facility	50	180
Total	10,501	12,896

If the growth of the service population varies from the projected values discussed above, it could impact the life span of the waste disposal cells as sized below. From discussions with Manitoba Infrastructure and Transportation, it is possible that the proposed correctional facility may be designed for a population greater than that discussed above, however final designs for the facility have not been prepared. If this was the situation, then the expansion cells would have a lessened capacity and a shorter lifespan.

2.5.5 Projected Waste Generation

The projected amount of solid waste generated by residents can be estimated from the existing waste generation data at the Dauphin WDG, studies done elsewhere in Canada, and data from other communities in Manitoba. The waste generation projections for the WDG site were based on the projected populations for the service area, the estimated per capita waste generation rate, the estimated waste diversion rate, and an estimated solid waste density. As there are no known significant waste-generating industries in the service area, commercial/industrial waste generation sources have not been included separately, but rather are included in the overall waste generation numbers.

2.5.5.1 Waste Generation

Municipal waste generation rates can vary greatly depending on location, as residents in urban centers typically generate more waste than residents in rural communities. Based on information reported by Statistics Canada (2010), the average per capita waste generation rate in Manitoba was estimated to be 0.88 kg/person/day for residential waste and 2.16 kg/person/day for residential and non-residential waste combined. From a review of the recorded residential, commercial and institutional waste quantities hauled to the site (2012 and 2013 records), it was estimated that the residents in the City and the correctional facility have an average waste generation rate of approximately 1.68 kg/person/day. This waste generation rate was utilized for estimating storage requirements of the WDG active cell(s) to design year 25.

From a review of the recorded residential, commercial and institutional waste quantities dropped off at the site (2012 and 2013 records), it was estimated that the rural residents in the RM have an average waste generation rate of approximately 0.51 kg/person/day. This waste generation rate was utilized for estimating storage requirements of the WDG active cell(s) to design year 25.

2.5.5.2 Recycling

The City of Dauphin has initiated a recycling program with Dauphin & District Recycling Inc., which operates through the curbside pickup of unsorted recyclable materials in a compacting truck. The recyclables are compacted, bailed and hauled to Portage & District Recycling Inc. for processing. Based on a review of residential recycling quantities recorded (2012 and 2013 records) from city residents, the average per capita recycling rate was 0.19 kg/person/day. The City of Dauphin has indicated that mandatory recycling will be instituted for city residents in the spring of 2015, therefore it is expected that the per capita recycling rate will increase once this mandate is instituted. Electronic waste products are collected at a separate facility operated by Parkland Regional Recycling in the City of Dauphin, and is operated through individual drop off.

The RM operates curbside recycling pick up in the villages of Sifton, Valley River and in the subdivisions of Eclipse, Lockville and Bloomfield. This recycling material is also sent to Portage & District Recycling Inc. for processing. The WDG site has separate compounds for the collection and temporary storage of metals, tires and plastic containers, and rural residents without curbside pick up can drop off recyclable materials at the recycling centre in the City of Dauphin. Based on a review of residential recycling quantities recorded (2012 and 2013 records) from rural residents, the average per capita recycling rate was 0.57 kg/person/day. These recycling rates were recorded separately from the residential waste generation rates discussed in Section 2.5.7.1 above (i.e. 0.51 kg/person/day solid waste + 0.57 kg/person/day recycling).

2.5.5.3 Compost

Based on the site investigation, the majority of the material currently being composted at the Dauphin WDG is yard and garden waste, dropped off by individuals from both the city and rural areas, and from curbside collection during the fall season. In addition, there is also occasional drop off of spoiled grain and oil seeds, which would be considered compostable material. From a review of the 2012 and 2013 records of yard and garden waste disposed of at the WDG site, the per capita compost generation rate is estimated to be 0.06 kg/person/day for city residents and 0.01 kg/person/day for rural residents. Based on the nature of the material, a solid waste density of 200 kg/m³ was assumed. Therefore the estimated volume of compostable material generated would currently be 937 m³/year, and would increase to 1,171 m³/year in design year 25.

2.5.5.4 City of Dauphin

The City currently utilizes a curbside waste collection program for both residential waste and recyclables on a weekly schedule. The residential waste collection occurs with the use of a garbage compaction truck. A solid waste density of 300 kg/m^3 is typical for compacted solid waste from a compacting collection truck. In addition to the compacting collection truck, the compactor onsite would increase the solid waste density further, and therefore a typical compacted solid waste density of 475 kg/m^3 was utilized in estimating the volume of waste generated from city residents. Based on the per capita waste generation rate of $1.68 \text{ kg/person/day}$ and the estimated solid waste density (475 kg/m^3), the current annual volume of residential waste generated is $10,997 \text{ m}^3/\text{year}$ and would increase to $13,808 \text{ m}^3/\text{year}$ in design year 25.

2.5.5.5 RM of Dauphin

The RM currently does not operate a curbside waste collection system for residential waste from rural residents. The RM does operate a WDG in the village of Sifton and there is a transfer station located at the RM office, which transfers waste to the Dauphin WDG. As the size and extent of the WDG in Sifton was minimal compared to the WDG in Dauphin, it was assumed that the waste from all RM residents will be hauled to the Dauphin WDG for future sizing considerations. If some of the waste material produced by the RM of Dauphin is offset by the presence of a WDG in Sifton, then this would result in a longer life span for the Dauphin WDG.

The residents in the service area utilize the WDG site by individual drop off of residential waste and truck hauling from the transfer station. A solid waste density of 130 kg/m^3 is typical for uncompacted solid waste; however, as the WDG site utilizes a compactor on a daily basis, a solid waste density of 475 kg/m^3 was utilized in estimating the volume of waste generated from the RM rural residents. Based on the per capita waste generation rate of $0.51 \text{ kg/person/day}$ and the estimated solid waste density (475 kg/m^3), the current and projected annual volume of residential waste generated would be $862 \text{ m}^3/\text{year}$.

2.5.5.6 Waste Generation Summary Table

The current and projected residential waste generation rates for the service area have been included in the summary table below and in the attached Table 1 (Appendix B).

Contributing Population	Current Annual Waste Generation (m ³ /year)	Year 25 Annual Waste Generation (m ³ /year)
City of Dauphin	10,997	13,808
RM of Dauphin	862	862
Total	11,859	14,670

2.5.6 Topography and Geotechnical Review

An onsite geotechnical and topographical investigation was completed on July 31 and August 1, 2014 to determine the suitability of the proposed upgrade and expansion areas for the siting and construction works.

2.5.6.1 Past Geotechnical Investigations

Groundwater Driller Well Logs

Driller well log reports for the quarter section of the existing WDG area were reviewed for background soils and groundwater information. Soils consisted of surficial sand followed by till, down to approximately 4.8 m below the surface. Below this was a layer of sand down to approximately 7.3 m below the surface, followed by shale. Standing water was noted in one well log at 1.2 m below the surface.

Canada-Manitoba Soil Survey

Based on the existing detailed Canada-Manitoba soils survey report of the Dauphin area (No. D-34, 1981), the soils in the existing WDG area are classified as Glenhope Series soils. These soils consist of imperfectly drained Gleyed Rego Black soils developed on thin, very strongly to extremely calcareous, moderately coarse to medium textured lacustrine sediments overlying loamy, extremely calcareous till. Surface textures may range from sandy loam to loamy very fine sand. The topography is level to very gently sloping, resulting in slow runoff. Permeability is moderate in the sandy surface sediments and slower in the loamy textured till substrate. This change in soil texture and permeability often creates a perched water table in the subsurface sediments during the spring runoff and following periods of heavy rain. Some Glenhope soils are slightly saline as a result of lateral seepage through more permeable surface sediments. Native vegetation is typically open stands of aspen and balsam poplar with surface meadow grasses and willow. Some Glenhope soils are cultivated and utilized for pasture.

Past Geotechnical Investigation

Past geotechnical information was obtained from a review of the document entitled *Geoenvironmental Investigation Livestock Disposal Site – Dauphin, MB* by UMA AECOM, 2008. The southwest portion of the landfill site was used as a dedicated cell for bovine deadstock, and as a requirement of Manitoba Conservation, the area required a geotechnical assessment to continue operation. There were six test holes

drilled at the site of interest to depths ranging from 6.1 m to 8.4 m, and four monitoring wells installed. The typical soil profile consisted of surficial topsoil to a depth of 0.6 m, followed by alternating layers of sand (0.8 m to 1.6 m thick) and silt (0.8 m to 3.1 m thick), with clay being found in four of the test holes beginning at depths ranging from 2.6 m to 6.8 m below the surface. The static groundwater levels varied in the monitoring wells from 0.93 m to 2.15 m below the surface, and the groundwater flow direction was inferred to be southeast, towards Salt Creek and the Vermillion River. The measured in situ hydraulic conductivity of the soil materials at the site ranges from 1.2×10^{-3} cm/sec to 8.2×10^{-5} cm/sec.

2.5.6.2 Onsite Geotechnical Investigation

An onsite investigation of geotechnical conditions was conducted by JR Cousin Consultants Ltd. on July 31, 2014. A tracked backhoe was used for excavating the test holes under the direct supervision of JRCC personnel. The land immediately surrounding the existing WDG cells to the south and east (within the property boundary), was investigated as a proposed expansion area for the compost storage pad, compost retention pond and expansion cells. The land was investigated to determine whether the soils would be suitable for use as a clay WDG liner in an undisturbed state (in situ) or after reworking, and whether soils could be used for potential borrow material during construction.

During the site investigation, nine test holes were excavated with a backhoe in the proposed expansion and development area, to a maximum depth of 5.0 m. The test hole locations are shown on Plan 2, attached in Appendix D.

The subsurface soil profile within each test hole was logged, water conditions were noted, and representative soil samples were collected as the soils varied along the profile. The samples were visually field-classified and confirmed through laboratory analysis. Shelby tubes of undisturbed in situ soil were collected in various test holes and at depths appropriate for a WDG cell liner. Bulk samples were also collected in various test holes and at various depths if testing of a reworked soil sample was deemed necessary. Following completion of the test holes, an assessment of the short term groundwater conditions was completed by measuring the static water level in the test holes and determining the elevation of water infiltration into the test holes. All test holes were then backfilled with excavation material. Details of each test hole soil profile, including depth and description of each soil layer, as well as comments on groundwater infiltration can be found in the test hole logs attached in Appendix C.

Soil Profile

Based on the soils observed in the test holes, the subsurface soil profile varied across the entire testing area, however similar soil types were observed in the

majority of the test holes. This does not represent areas previously disturbed by land filling activities (i.e. TH 9).

The general soil profile consisted of a layer of surficial black topsoil varying in thickness from 0.2 m to 0.5 m, with the top 0.01 m consisting of vegetation roots. The topsoil was consistently followed by layers of fine grain sand and silt to depths of 0.9 m – 1.4 m below the surface. Below were alternating layers of low plastic clay till, low plastic silt till and sandy till down to the bottom of the test holes at 5.0 m below the surface. These layers were not consistently found in the same order in each of the test holes or with the same thickness throughout the expansion area, making it difficult to predict a consistent elevation for each layer. In addition, TH5 consisted of alternating layers of sand and silt till, with no layer of clay till observed.

Details of the soil profile in each test hole can be found in the test hole logs, attached in Appendix C.

Groundwater and Bedrock

Water infiltration and short-term water accumulation was recorded in the test holes during the test hole excavation and prior to backfilling. Water infiltration was observed at depths of 1.2 m to 2.6 m below the surface, while standing water was recorded at depths of 3.8 m to 4.9 m below the surface. The groundwater levels recorded in the test holes can vary based on seasonal conditions, i.e. snowmelt and high precipitation during rainy seasons. In general, the majority of the test holes experienced caving conditions, likely due to the sandy layers in the soil profile.

Refusal or bedrock was not encountered at any of the test holes, however boulders were frequently encountered in the silt till and sandy till layers.

Contractors should be made aware of the geotechnical conditions encountered onsite, as dewatering and slope stabilization may be required during construction, depending on the depth of excavation determined during final design.

Laboratory Analysis

Representative bagged soil samples from the proposed WDG compost area, storage pond and future active cells were submitted to Stantec Consulting Ltd. for testing and analysis. The following is a summary of the testing results, while details of soils analysis and testing results from the laboratory are attached in Appendix C.

The eight bagged samples were analyzed for the following:

- Atterberg Limits (plastic limit, liquid limit, and plasticity index, ASTM D4318)
- Soil Classification (ASTM D2487)
- Moisture Content (ASTM D2216)

- Particle Size Analysis (Hydrometer test, ASTM D422)
- Visual Classification.

In addition, two bulk samples, from the proposed WDG expansion area, were reworked and tested for:

- Standard Proctor Density (ASTM D698)
- Hydraulic Conductivity (ASTM D5084).

The eight bagged soil samples analyzed were from the following test holes:

- TH2 1.2 m – 2.9 m
- TH2 2.9 m – 3.8 m
- TH3 0.0 m – 0.2 m
- TH3 0.3 m – 1.0 m
- TH4 2.0 m – 3.0 m
- TH7 1.2 m – 2.4 m
- TH7 3.1 m – 5.0 m
- TH8 0.3 m – 1.4 m.

The reworked bulk samples analyzed were from the following test holes:

- TH2 1.2 m – 2.9 m
- TH7 1.2 m – 2.4 m.

JRCC requested that the laboratory also provide a professional assessment, based on the analysis and the testing, as to whether the soil samples could achieve a permeability of 1×10^{-7} cm/sec or less in their in situ and reworked states. A summary of the laboratory results are as follows:

The laboratory analysis of the bagged samples from the potential expansion area indicated that the soils consisted of CL/ML – low plastic sandy clay and silt. The laboratory indicated that in general, homogeneous soils with a Plasticity Index greater than 25 and a clay content greater than 50% would typically be expected to achieve a hydraulic conductivity of 1×10^{-7} cm/sec or less. The Plasticity Index in the bagged samples ranged from 4 to 17 and the percentage of clay ranged from 13% to 37%. Based on these results none of the soils were considered suitable for use as a clay liner both in situ or when reworked and compacted, according to the soils analysis report. The laboratory also noted that comments regarding the potential use of the material as a liner are based upon the soil being homogeneous with no preferential flow paths. It should be noted that estimating the hydraulic conductivity of a soil based upon classification test results (plasticity index and particle size analysis) of

individual bagged samples alone might be misleading if the in situ soil material contains layers or pockets of sand, silt, or organic material.

The two reworked bulk samples submitted to Stantec Consulting were both located in the CL - low plastic sandy clay layers, to the east of the existing WDG, which were determined to have the greatest potential for use in a clay cell liner. These samples were tested to determine the Standard Proctor Density and reworked hydraulic conductivity (permeability). The samples were reworked to 96% of the Standard Proctor Density at the optimal moisture content (13.5% for TH2 and 11.5% for TH7). A permeability test of reworked soils in the laboratory is expected to be an accurate representation of reworking soils during construction and is therefore used to estimate the hydraulic conductivity in a liner of reworked soil material. The results of the reworked permeability testing were hydraulic conductivity values of 1.3×10^{-8} cm/sec (TH2) and 2.8×10^{-8} cm/sec (TH7), which are both within the required design parameters of a WDG clay cell liner, as discussed in Section 2.5.9 below.

These results contradict the results of the analysis conducted on the bagged soil samples obtained from the same layers of soil, which were initially deemed unsuitable for use as a clay liner when reworked. It is expected that the reworked permeability testing is a more accurate determination of the suitability of soils for use as a potential soil liner than the analysis of disturbed bag sample, therefore the results of the reworked permeability analysis should have a greater influence on determining suitability of the soils for liner construction.

2.5.6.3 Topography

A topographical survey of the proposed expansion areas and the test holes in was completed using GPS survey equipment. Based on site observations, the general expansion area to the east and south of the existing WDG cells was relatively flat grassland, with some low lying areas that had standing water. The land was generally sloped toward the north and east. A maximum elevation difference of approximately 0.95 m was observed between the southwest and northeast corners of the expansion area. The ditch along Road 147 N, to the south of the expansion area, was sloped towards the east away from the WDG site.

2.5.6.4 Groundwater Elevation and Flow Direction

The groundwater elevation was calculated based on the measured depth to groundwater and the ground elevation at each monitoring well. The depth to groundwater (measured from the ground surface at the well) in each monitoring well was measured and recorded by lowering a weighted measuring tape down the well. The ground elevation was determined utilizing GPS survey equipment. A summary of the groundwater elevations and depth to groundwater in the monitoring wells is provided in Table A below.

Table A: Groundwater Elevations and Depths in Monitoring Wells at the Dauphin WDG

Well	Date	Ground Elevation (m asl)	Depth to Groundwater (m)	Groundwater Elevation (m asl)
MW1	31/7/14	300.185	1.71	298.475
MW2	31/7/14	299.898	1.40	298.498
MW3	31/7/14	299.244	1.53	297.714
MW4	31/7/14	298.312	0.84	297.472

From the groundwater elevation data obtained from the site, groundwater flow was determined to be toward the southeast direction; based on the assumption that groundwater is flowing from areas of higher elevation to areas of lower elevation. This most recent data indicating groundwater flow direction is in agreement with the flow direction reported in the 2011 geoenvironmental investigation report. The groundwater levels during this recent investigation were slightly higher than in the previous [2008] investigation. It is not unusual for groundwater levels to fluctuate seasonally or annually, based on variable precipitation levels.

2.5.7 WDG Cell Liner Requirements

The *Manitoba Siting Guidelines for Class I WDG Sites* and the existing operating permit of the Dauphin WDG both require a clay liner of a waste disposal cell to have a minimum thickness of 1.0 m and have a hydraulic conductivity of 1×10^{-7} cm/sec or less. If suitable soils are not available for this construction, then a synthetic geomembrane liner can also be utilized. This low level of permeability in the active cell liner is required to ensure that leachate or wastewater does not impact surrounding groundwater resources. The operating permit also requires that the compost retention pond is constructed with a liner that achieves a hydraulic conductivity of 1×10^{-6} cm/sec or less and is a minimum of 1.0 m thick.

The design and construction of the compost area would be in accordance with the *Draft Manitoba Compost Facility Guidelines*, which require that the composting area be underlain with a synthetic liner or a minimum 0.5 m thick clay liner having a permeability of 1×10^{-7} cm/sec or less. The compost and curing areas must also be located a minimum of 0.5 m above the seasonal high water table level and have positive drainage throughout to control run-off and minimize ponding. From discussions with Manitoba Conservation, other composting areas on WDG sites in Manitoba have been constructed with thicknesses of 1.0 m and permeabilities of 1×10^{-6} cm/sec. However, as the compost pad at the Dauphin WDG would be constructed on top of a decommissioned WDG cell, which would already have a 0.5 m cap and to reduce costs for soil material required, a 0.5 m liner with a permeability of 1×10^{-7} cm/sec is being proposed.

In addition, the *Manitoba Siting Guidelines for Class I WDG Sites* describe the geological sensitivity of a site as being very high, high, moderate or low, based on the estimated vertical time of travel for liquid contaminants through the sub soils. Sites with a very high sensitivity

would have an estimated time of travel of weeks to months until the contaminants reach the aquifer, while a site with a low sensitivity would have an estimated time of travel of several decades to a century before the contaminants would reach the aquifer. This not only considers the permeability of the soils below the active area, but also the depth of the overburden soils prior to reaching the aquifer of concern. Constructing a liner for the expansion cells, compost pad and retention pond, reduces the geological sensitivity of the site as it reduces the time of contaminant travel.

2.5.8 Contaminant Migration

The potential impact of leachate from the WDG on the underlying groundwater aquifer was evaluated to determine the geological sensitivity rating for the site. The following assumptions were made:

- leachate movement by advection
- no natural attenuation of leachate
- a hydraulic conductivity value of 1.0×10^{-7} cm/s for the clay cell liner material was estimated from the minimum hydraulic conductivity value permitted by Manitoba Conservation
- a vertical gradient of 0.54 down towards MW4, calculated by the hydraulic head and well depth in MW1 and MW4, based on measurements taken during the site investigation
- an average effective porosity of 0.1 was based on estimated values for the sandy clay material.

The vertical rate of contaminant migration was calculated using Darcy's Law where:

$$q = \frac{Ki}{n_e}$$

Where: q = average linear velocity of the contaminant
K = average hydraulic conductivity of the soil
i = average hydraulic gradient
ne = average effective porosity of the soil.

Using the above parameters the average downward velocity of the contaminant is calculated as:

$$q = \frac{(1.0 \times 10^{-7})(0.54)}{(0.1)} = 5.4 \times 10^{-7} \frac{cm}{s} = 0.17 \text{ m/year}$$

Based on the results of the estimated hydraulic conductivity of the clay cell liner and utilizing a depth of 1.0 m for the horizontal liner material, any potential contaminants would migrate to the bottom of the liner in approximately six years. This would correspond to a geological sensitivity rating of moderate, defined by *Manitoba Siting Guidelines* as "water moving vertically will reach the aquifer within years to decades". Based on the results of the soils permeability testing it is probable that the hydraulic conductivity of the liner will be less than 1×10^{-7} cm/sec, however

the above is a “worst case scenario”. The cell liner material will be utilized as a natural barrier to reduce leachate migration.

2.5.9 Conceptual Design

2.5.9.1 Proposed Development

The proposed development is for the WDG will consist of constructing a compost pad and a leachate retention pond for the compost area, along with future expansion cells for waste disposal. From a review of the projected waste generation, each new waste disposal cell constructed should have capacity for a minimum of five years of operation. The expansion cells would be located directly east and southeast of the existing waste disposal cells. The WDG cells, compost area and retention pond would be constructed for a design life of 25 years based on the projected waste generation loadings, however changes in waste generation, waste diversion and population growth will impact this design life.

The internal site access road would be extended into the expansion area to allow vehicle access to the expansion cells for waste drop off. The proposed waste disposal cells and access road would require perimeter ditching to connect with the existing ditching at the WDG site. The raised dikes around the compost pad, retention pond and expansion cells would prevent surface drainage from entering these areas. The compost area would be constructed with a floor sloped towards the leachate retention pond, allowing gravity flow of the liquid into the pond located to the east. The proposed site layout of the upgraded site with expansion cells is shown in Plan 3 of Appendix D.

Conditions of the Environment Act Licence would be met through the upgrade and expansion works along with the site operations. Site operations would remain relatively the same, with regular compaction and covering of residential waste material in the waste disposal cells and regular mechanical turning of the compost material. The operator would need to regularly check the liquid level in the leachate retention pond to ensure liquid level does not exceed the design levels.

2.5.9.2 Storage Requirements

Based upon the projected waste generation rates for the site over 25 years, the expansion area within the WDG site boundaries would be utilized for five expansion cells, the compost area and leachate retention pond. In a WDG, solid waste can be disposed of both below and above grade, depending on soil and groundwater conditions, minimizing the total surface area required for the waste disposal cells. The cell sizing herein is based on an excavation of 2.0 m below the surface and the waste being extended to a height of approximately 6.0 m above the ground surface. For sizing the expansion cells, the below grade side slopes were assumed to be 3H:1V, while the above grade portion of the cell would have side slopes of 5H:1V. Due to the dimensions and shape of the expansion area, the expansion cells will have

varying flat bottom surface areas, however storage capacity should be similar in each expansion cell to allow for an overall sufficient storage capacity to design year 25.

2.5.9.3 Conceptual Liner Design

Based on the results of the onsite investigation and laboratory analysis, the layer of low plastic sandy clay and clay till soil found throughout the potential expansion area would be suitable for use as a WDG cell and leachate pond liner when reworked and compacted. Excavating and reworking the soils would significantly reduce the potential for preferential flow paths in the cell liner from the presence of large rocks or unsuitable soil material (silt and sand). If a pocket or seam of unsuitable material or large rocks is discovered in the soil layer during construction, these unsuitable materials should be removed and replaced with suitable reworked soil material.

When soils are reworked and compacted the structure is typically altered in such a way as to create a liner with much lower hydraulic conductivity than the native in situ soils. As these sandy clay and clay till soils were observed in the majority of the test holes in the potential expansion area, it is likely that these soils would consistently achieve a hydraulic conductivity of 1×10^{-7} cm/sec or less when reworked and compacted. Therefore, it is recommended that the soils that form the horizontal floor and vertical cut-off walls of the WDG expansion cells, compost pad and retention pond be constructed with reworked and compacted soils from the suitable soil layers in the expansion area. Both the vertical cut-off walls and horizontal floor liners would need to be constructed with a minimum thickness of 1.0 m in the expansion cells and leachate retention pond, while the liner for the compost pad constructed with a minimum thickness of 0.5 m.

2.5.9.4 Monitoring Wells

As the expansion cells will be constructed with proper soil liners, it is expected that leachate will be contained within the site and will not contaminate groundwater. However, Manitoba Conservation guidelines suggest a groundwater monitoring system comprised of a minimum of three monitoring wells (one up gradient and two down gradient of the WDG, on the basis of the assumed direction of the groundwater flow).

The site currently has four monitoring wells installed on the south boundary of the WDG site. Two additional monitoring wells are proposed to be installed at the WDG site, one up gradient and one down gradient of the existing and proposed waste disposal cells (see Plan 3 in Appendix D). The monitoring wells will be installed below the floor elevation of the expansion cells. The existing monitoring wells would be maintained at the site for continued sampling and monitoring of groundwater parameters.

2.5.9.5 Cover System

The active portion of the expansion cells are proposed to have a compacted layer of clean soil cover material (0.15 m thick) applied daily. In sizing the expansion cells, it was assumed that the cover material will comprise approximately 20% of the total cell volume. Any additional soil material excavated from the cell construction would be stockpiled and utilized as soil cover material in future site operation.

2.5.9.6 Cell Closure

The expansion cells, when at the maximum height above ground as previously described, would be capped with 0.5 m of compacted clay type soil and topsoil, as prescribed in the Manitoba Conservation guidelines. The site will also need to be graded to provide positive drainage off of the site and seeded to provide an aesthetically pleasing natural environment upon closure.

2.5.9.7 Leachate Management System

As a requirement of Manitoba Regulation 150/91, and the *Waste Management Facilities Regulation*, leachate produced at a WDG needs to be contained within the boundaries of the WDG and should not contaminate groundwater. Leachate has a potential to be produced when decomposing waste material comes in contact with water, and occurs most frequently in an active residential waste disposal cell or a compost area.

The proposed compost area would be constructed with a dedicated leachate retention pond, with the floor of the compost area cells being graded in such a way that liquid would drain along the surface into the leachate retention pond via gravity (see Plan 3 and 4 in Appendix D). This leachate management system shall be utilized to collect and remove leachate generated from the compost processing, curing and storage area.

The leachate retention pond for the compost area will be a one cell structure requiring a liner with a permeability of less than 1×10^{-6} cm/sec and a minimum thickness of 1.0 m to prevent groundwater contamination. The retention pond is proposed to have an operating depth of 2.0 m, a freeboard height of 0.5 m, an inner slope of 4H:1V, and a hydraulic capacity of approximately 2,200 m³. The retention pond would be excavated approximately 2.5 m below grade and with outer dikes constructed to a minimum height of 0.5 m above grade, with 3 m wide dike tops. Compaction will be provided to form stable structures. Details of the dike and liner construction are shown on Plan 4 in Appendix D.

It is anticipated that liquid in the leachate retention pond will evaporate over time and maintain a balanced liquid level, however liquid can build up in the pond depending on the amount of precipitation experienced in a given year. Liquid in the pond can also be pumped and sprayed back onto the compost windrow piles to increase

moisture content and decomposition rate of the compost, as well as increasing the evaporation rate of the liquid. The retention pond was sized according to the footprint of the compost area and the expected annual precipitation and net evaporation over the area. Therefore, the pond would have sufficient storage for precipitation falling on the compost area and leachate pond for a one year period, with the remaining freeboard to the top of dike utilized for years with access precipitation. Based on climate data from 1981 to 2010 provided by Environment Canada, the total amount of precipitation expected to fall on the area is 482 mm/year. Therefore, over the surface area of the compost area and leachate pond, the total amount of leachate generated would be approximately 2,200 m³/year. Evaporation data was not available for the region. If liquid in the pond builds up to the point of overflowing, it should be sprayed on the compost piles to increase evaporation and Manitoba Conservation should be contacted to determine the most appropriate course of action.

2.5.9.8 Compost Area

Based on the *Draft Manitoba Compost Facility Guidelines*, a liner 0.5 m thick, with a permeability of 1×10^{-7} cm/sec would be required below the composting storage pad. This liner could be obtained from reworking the sandy clay and clay till material excavated from the expansion cells. In addition, alternative materials such as compacted asphalt millings from the City of Dauphin public works operations can be used as a working surface to prevent liner destruction during mechanical turning of the compost material. The compost area is proposed to be located on top of a decommissioned waste disposal cell on the south side of the WDG site (see Plan 3 in Appendix D); therefore the subsoil material should not be disturbed during the construction of the compost pad, however the topsoil layer will be removed prior to construction of the pad. This is adjacent to the current compost drop off area, which will continue to be used as an after-hours drop off location. The base of the compost pad will be constructed with a typical slope of 2% to 4% towards the retention pond to the east, to allow for natural surface runoff directly into the retention pond.

The compost area will consist of several windrows for active decomposition and an area for compost curing and final product. The compost area will have a containment berm of compacted soil placed around the perimeter with a minimum height of 0.5 m above the surrounding ground surface, to prevent surface run-off water from entering the compost area during a storm event.

2.5.9.9 Drainage

The proposed perimeter ditching throughout the expansion area would drain to the ditch along Road 147 N. Based on survey data and a review of topographical mapping for the area, it appears that the existing ditch along Road 147 N flows towards the east from the WDG site to Salt Creek (third order provincial drain), which flows northeast toward the Vermilion River (see Plans 1 and 3 in Appendix D).

2.5.9.10 Access Road

The existing all-weather access road to the WDG site [Road 147 N] is well maintained and will continue to be utilized for access to the site. From site observations, the interior roads accessing the compounds and cells will need to be extended into the expansion area and compost area utilizing granular materials. Access to each of the proposed expansion cells will be required with truck turnaround areas at the proposed drop off locations. The proposed interior roads would have adequate width for two-way traffic and would be able to withstand heavy equipment traffic. The proposed road base would consist of compacted subgrade, geotextile, C base granular material and A base granular material [see Plan 5 in Appendix D].

2.5.9.11 Fencing and Signage

The proposed WDG expansion cells will require a 1.8 m high movable chain link fence to be placed around the active cell to prevent windblown debris. The compost area and leachate retention pond are proposed to have a 1.2 m high perimeter fence consisting of four strand barbed wire and wooden posts, with a gate large enough for vehicle access [see Plan 5 in Appendix D].

Signs indicating drop off locations will be placed at the truck turnaround areas of the proposed waste disposal cells, and compost area. Warning signs should also be posted at the leachate retention pond.

2.5.10 Construction Techniques

The reworked soils forming the vertical cut-off walls are to be constructed to a minimum width of 1.0 m, however to accommodate typical construction equipment and vehicle access requirements it is assumed that the cut-off wall will have a minimum width of 3.0 m. The cut-off wall would extend to a depth of 1.0 m below the horizontal liner elevation. For the purpose of sizing the site, the active cell floor elevation for each of the waste disposal cells will have an average depth of approximately 2.0 m below the average surface elevation in the expansion area. Details of the dike and liner construction are shown on Plan 4 in Appendix D.

For dike and liner construction, the excavated material is to be compacted with to a minimum Standard Proctor Density of 98%, in lifts of 150 mm. The dike and liner material should be compacted with a minimum of eight passes of a sheepsfoot roller on each 150 mm lift. A limited range of moisture content will be permitted during construction. The material shall not be so wet nor so dry that compaction equipment cannot compact the fill into a homogeneous mass. Material too wet shall be dried or wasted and material too dry shall be wetted. The cell bottom will be graded to a tolerance of ± 50 mm. The inner and outer dikes would be constructed with a mixture of excavated soil material (clay, silt, topsoil).

The construction specifications should indicate that the sheepsfoot roller shall have a minimum foot pressure of no less than 1,700 kPa (250 psi). The drum diameter of the sheepsfoot roller

should not be less than 1,200 mm. Each roller should be equipped with cleaning fingers designed to prevent the accumulation of material between the tamping feet. The foot pressure would be calculated by taking the total mass of the roller and dividing it by the greater of: the area of the maximum number of tamping feet in one row parallel to the axis of the roller, or by 5% of the total foot area. The roller feet should be at least 200 mm long and should have a minimum area of at least 4,500 mm².

2.5.11 Decommissioning and Closure

The proposed waste disposal cells, when at maximum height above ground, will be decommissioned by covering with a minimum of 0.5 m compacted clay soil and topsoil as per *Manitoba Conservation Siting Guidelines* and Reg. 150/91. The surface of the capped cells will be graded to allow positive drainage away from the site. The site will be seeded with grass to provide an aesthetically pleasing environment, and regular monitoring of the site will continue to occur to determine if there are any impacts to groundwater at the site. The existing and proposed monitoring wells should be sampled and tested on a regular basis for the baseline water chemistry parameters as prescribed by the operating permit and Environment Act Licence.

The final contours of the finished cells are proposed to be such that they will have a maximum finished elevation of approximately 6.5 m above the original average prairie grade. The outside slopes of the capped cells should be a minimum of 5H:1V. The final contour of the cells will assist in minimizing infiltration of water, preventing surface water ponding and retaining slope stability. A top layer of organic soils seeded with grass will be placed to provide a vegetative cover that will further reduce the potential for erosion by wind or surface run-off, and reduce infiltration of precipitation through evapotranspiration.

2.5.12 WDG Maintenance and Operation

2.5.12.1 General Site Operation and Maintenance

The WDG site will have designated and trained operators from the City of Dauphin public works department to handle the following tasks:

- Collecting tipping fees at the gate entrance
- Recording waste quantities dropped off at the site
- Directing the public to the appropriate drop off locations
- Moving, covering and compacting waste material in the active waste disposal cells daily
- Inspecting and maintaining the fencing, gate and lock
- Ensuring the entrance gate is locked at all times when the operators are not present
- Ensuring burning activities are continuously monitored
- Ensuring compost material is mechanically turned regularly

- Ensuring the liquid level in the leachate retention pond is maintained at an acceptable height
- Ensuring recyclable materials are hauled off site regularly and that compounds do not reach capacity
- Ensuring that unacceptable waste products are not dumped at the site
- Ensuring internal access roads are cleared and maintained regularly
- Ensure windblown waste material is cleaned up regularly.

2.5.12.2 Compost Operation and Maintenance

It is expected that compost waste material will be deposited by individual drop off at the designated receiving area of the WDG and by curbside pickup in the fall season. The compost material will be placed into windrows at the site and mechanically turned to assist in aeration and speed up the decomposition process. The windrows will typically be turned mechanically with available equipment six to eight times before the final product is fully cured. A minimal internal temperature of 55°C should be maintained in the windrow throughout this period, to allow for sufficient decomposition and pathogen destruction. This phase of decomposition typically lasts four to five weeks, under ideal conditions. Beyond mechanical aeration (turning), other factors such as moisture content, particle size, and the carbon to nitrogen ratio, contribute to successful decomposition of the organic material. In general, the more controlled these factors are the faster the composting process will take place. The compost is then permitted to sit and stabilize before being distributed to residents. Typically, the compost should age for approximately one year to be considered safe for distribution.

3.0 POTENTIAL ENVIRONMENTAL IMPACTS

The biophysical and socioeconomic environment as related to the development, and potential impacts of the development on the environment.

3.1 Releases to Air, Water, Land

3.1.1 Air

Prevailing winds in the area can carry odours if the waste disposal areas are exposed and wind breaks are not utilized around the site. These odours have the potential to be a nuisance to nearby residents.

While there is potential for odours at the WDG site during operation, the site is approximately 2 km from residents in the City of Dauphin and 800 m from the nearest rural resident. In addition, with daily waste cover material being utilized, odours are not likely to become a nuisance. With proper containment and operation of the compost piles, the odours generated from composting can also be adequately controlled. The site is also bordered by a tree line which acts as a windbreak to reduce the spread of odours.

There is also a potential for greenhouse gas emissions during construction and operation works from heavy equipment and transport vehicles. As heavy equipment is currently utilized daily from site operations, there would only be a minor increase during the construction works, with additional heavy equipment on site. Impacts from dust generation are not expected to be significant as the construction area will meet the minimal setback distances from residences, and a treed windbreak exists around the border of the site to reduce the likelihood of dust being carried to nearby residences.

3.1.2 Water

Pollutants that have the potential to be released into surface water and groundwater during the operation of WDG would be from leachate production. Pollutants potentially produced in waste disposal cells would generally include nutrients, coliforms, volatile organics, suspended solids, heavy metals, inorganic compounds and organic carbons that are typical for leachate produced from residential wastes. Pollutants potentially produced in compost leachate would generally include nutrients, coliforms, suspended solids and organic carbons.

Pollutants that have a potential to be released into the surface water or groundwater during the WDG upgrade and expansion construction activities, would include petroleum hydrocarbons (PHCs) from heavy equipment spills/leaks and sediments from soil erosion.

3.1.3 Land

The landscape would be altered by construction of expansion cells which will extend approximately 6.5 m above the surrounding grade. Perimeter dikes, ditching and fencing would also be constructed/installed around the perimeter of the expansion cells and compost area.

Leachate and windblown litter can impact surrounding lands if not contained. Ground areas disturbed by construction activities can be impacted through soil erosion if not covered or re-vegetated shortly after works are completed.

Pollutants that may be released to the land are predominantly PHCs, which could be released during construction activities from equipment leaks, and/or re-fuelling incidences and could result in impacts to the soils/land.

3.2 Wildlife

The WDG site is located in the “Interlake Plain” Ecoregion of Canada. Characteristic wildlife includes: white-tailed deer, black bear, moose, beaver, coyote, snowshoe hare, and eastern cottontail. Bird species include waterfowl, cormorant, gull, tern, heron, American white pelican and grebe. Wildlife common at landfill sites include rodents, gulls and crows. No wildlife other than gulls and crows were observed at the site during the site investigation.

The typical concern on any construction project is that wildlife species would be displaced through the construction works. However from observations made during the site investigation it is unlikely that the construction works will have any significant impact on wildlife or wildlife habitat in the area, as the development site is cleared section of land adjacent to active waste disposal cells and surrounding farming activities. In addition, the expansion area is also bordered by an all weather municipal road and CN Railway Line, therefore human activity in the area is evident and this would typically detract wildlife from the area. The construction of a leachate retention pond could attract more waterfowl (i.e. geese and ducks) to the site.

In addition, the Manitoba Conservation Data Centre and Wildlife and Ecosystem Protection Branch were contacted regarding occurrences of rare or endangered wildlife and bird species in their database for the proposed expansion area. The response indicated there were no occurrences of rare species identified in the area of the proposed development, based on information in the provincial database (see email correspondence attached in Appendix B).

3.3 Fisheries

The typical concerns with impacts to fish and fish habitat are from sediments released during construction and the leachate discharges into a body of surface water utilized by fish species. These impacts could include the reduction of water quality or physical disturbances that would create an unfavorable environment for fish or fish eggs.

Salt Creek is the nearest body of surface water and would be considered the “receiving stream” of any surface runoff from the WDG site. Based on information provided by Manitoba Conservation Fisheries Branch, Salt Creek is an intermittent stream and the only fish species reported in the creek were Fathead Minnow and White Sucker.

Potential impacts to fish species in Salt Creek are unlikely, as leachate would not be permitted to be discharged off of the WDG site. Any sedimentation from construction works would be controlled with the use of stenlogs in the municipal road (Road 147 N) drainage ditch.

3.4 Forestry

The area of the WDG expansion is a cleared parcel of land, therefore no potential impacts to forestry in the area are expected, as tree removal will be minimal and the area is not commercially forested.

3.5 Vegetation

Characteristic vegetation in the “Interlake Plain” Ecoregion is a mixture of farmland and deciduous boreal forest. The native landscape is characterized by trembling aspen, balsam poplar, white spruce, tall shrubs and ground cover of mixed herbs. During the site investigation, wild grasses and some scattered bulrushes and reeds were observed in the expansion area, while the tree line surrounding the site consisted of trembling aspen. This tree line did have some gaps which should be replaced with tree planting in the future.

The typical concern on any construction project is the removal of vegetative species through the construction works, however as the expansion area has been cleared of trees there will be a minimal loss of native vegetation. The majority of the vegetative species to be removed will be native grasses from the expansion area. Manitoba Conservation Wildlife and Ecosystem Protection Branch was contacted regarding occurrences of rare or endangered vegetative species in their database for the proposed expansion area. The response indicated that there were no occurrences of rare species identified at the proposed development site (see email correspondence attached in Appendix B).

3.6 Noise Impacts

There is a potential for noise impacts in the immediate area of expansion due to the heavy equipment utilized during construction, however these impacts are not expected to be significant, as heavy equipment is already being used at the site during daily maintenance. No additional noise impacts are expected during operation of the expanded and upgraded WDG as no additional maintenance equipment will be utilized.

3.7 Health and Safety

There is a potential for impacts to the health and safety of workers and the public during the construction works, as heavy equipment will be utilized on site while the public has access to other areas of the WDG.

3.8 Heritage Resources

The City of Dauphin was not aware of any historic, traditional or heritage resources located at the proposed expansion site. The Manitoba Historic Resources Branch was contacted regarding the proposed site. The Historic Resources Branch indicated that there have been no previously recorded heritage sites in the area of development and therefore have no concerns with the project (see memorandum from Manitoba Historic Resources Branch attached in Appendix B).

While impacts to historic or heritage resources are not expected at the site, there is always potential for an unexpected discovery when excavating an area that has not recently been excavated.

3.9 Socio-Economic Implications

The WDG upgrade/expansion is not expected to have adverse socio-economic impacts. In fact, construction related economic activity is likely to have a positive economic impact on the City of Dauphin, due to the relative distance from the development site. In addition, the City and RM would have increased waste storage capacity and composting capabilities upon completion of the project. The mature compost produced at the WDG site will also benefit the City of Dauphin and residents as it would be used as a soil conditioner in place of chemical fertilizers.

Traffic along Road 147 N would increase minimally from heavy construction equipment travel to and from the WDG site during construction, however no impacts from traffic are expected during operation of the upgraded and expanded site. There is also room on the site for parking construction equipment and transport vehicles, therefore traffic should not be impacted while onsite or while travelling to the site, due to parked equipment/vehicles.

3.10 Aesthetics

The WDG expansion and upgrade will have an impact on the general aesthetics of the area, as the WDG cells would be extended to approximately 6.5 m above the surrounding grade. The works would occur adjacent to Road 147 N, however this is not a main through road in the area and the tree line around the perimeter of the site would be maintained to limit the visual impacts to residents in the area. Windblown litter is also a concern at WDG sites as it creates a site which can be aesthetically unpleasing.

4.0 MANAGEMENT PRACTICE

Proposed environmental management practices to be employed to prevent or mitigate adverse implications from the impacts identified above.

4.1 Mitigation of Impacts to Air

To reduce the potential for nuisance odour impacts, the upgrade and expansion will be located beyond the minimum setback distances to nearby rural and city residents. While the site is surrounded by a tree line as a windbreak, the City of Dauphin will be encouraged to plant additional trees in areas where the tree line is gapped to provide a better windbreak and visual barrier. Regular covering of the waste disposal cells and proper operation of the compost piles will reduce the odours generated from the site.

Emissions from construction equipment and transport vehicles will be controlled through regular maintenance by the contractor, and should meet all provincial and local emission standards. Dust suppression methods (i.e. water spraying) can be utilized at the construction site if dry conditions create excessive dust through construction activities and transport, and becomes a nuisance to nearby residents.

4.2 Mitigation of Impacts to Water

Impacts to surface waters and groundwater from leachate production will be reduced by the construction of soil cell liners, meeting the permeability requirements by Manitoba Conservation, for the expansion cells, compost pad and leachate retention pond. Discharge of leachate from the expansion cells and retention pond is not typically permitted at WDG sites by Manitoba Conservation. Leachate produced will be contained in the retention pond and in the waste disposal cells and will be dissipated through natural evaporation.

Siltation in nearby surface waters from disturbed soil areas during the construction works will be mitigated through the use of stenlogs in the drainage ditch along Road 147 N. Any excess soil stockpiles produced onsite from the excavation works would be seeded upon completion to reduce erosion. Dike and ditch slopes would also be seeded with grass to control erosion.

To minimize impacts from construction equipment leaks or spills, the construction contractor will be responsible for maintaining heavy equipment to prevent leaks and spills of fuels, lubricants, hydraulic fluids or coolants. In addition, the construction specifications should outline to the contractor the requirements for handling and storage of fuels and hazardous materials during construction, as per federal and provincial regulations. The construction specifications should state wording similar to the following:

- Diesel or gasoline should be stored in double walled tanks or have containment dikes around fuel containers for volumes greater than 68.2 L (15 gallons) or in compliance with provincial regulations
- Clean up material should be available at the site, consisting of a minimum of 25 kg of suitable commercial sorbent, 30 m² of 6 mm PVC, and an empty fuel barrel for spill collection and disposal

- Fuel storage and hazardous material areas established for project construction should be located a minimum of 100 m from a waterbody or drainage route
- There can be no re-fueling or servicing of construction equipment within 100 m of a water body or drainage route
- Waste hazardous materials from construction activities and equipment must be properly collected and disposed of in compliance with provincial regulations
- In the event of spills or leaks of fuels and hazardous materials, the contractor or operator should notify the project engineer and provincial authorities (Manitoba Conservation at (204) 944-4888).
- Hazardous material handling and storage are to follow all provincial and federal regulations including WHMIS and spill containment requirements.

4.3 Mitigation of Impacts to Land

To minimize impacts to the surrounding land, containment dikes and fencing around the expansion cells, compost area and retention pond will act to contain leachate and windblown litter to the designated areas. Daily cover also acts to prevent windblown litter and the production of leachate in the waste disposal cell. Disturbed ground surface areas will be seeded upon completion of construction works to minimize soil erosion. To minimize the potential for slope erosion, the outer dike slopes would be seeded with grass upon completion of construction. To minimize the potential for the release of PHCs into the soil, the mitigation measures described in Section 4.2 above, outlining equipment maintenance and fuel-handling procedures, should be followed.

4.4 Mitigation of Impacts to Vegetation

The removal of surface vegetation will be limited to the construction area by clearly marking the site boundaries prior to construction. Vegetation outside of this construction area will not be damaged and the tree line surrounding the site will remain intact. Soil surfaces exposed during the construction works will be seeded with grass upon completion of construction.

4.5 Mitigation of Noise Impacts

To minimize the potential for noise impacts, construction equipment and transport vehicles should have mufflers working properly, and construction activities should be limited to daylight hours only.

4.6 Mitigation of Impacts to Health and Safety

To minimize impacts to health and safety of workers and the public, the construction contractor should have a safety program in place, in accordance with all federal and provincial health and safety regulations. During construction, access to the construction areas will be limited to the construction crew only. Personal protective equipment will be worn by construction crew in accordance with the contractor's safety program, while in the construction area.

4.7 Mitigation of Impacts to Heritage Resources

If any significant historic or heritage resources are discovered in the course of excavation or construction, the specifications should identify that works are to temporarily cease and an investigation of the site is to be conducted by the City of Dauphin, Manitoba Historic Resources Branch and any other provincial or federal authority as may be required.

4.8 Aesthetics

Impacts to aesthetics at the WDG site would be mitigated by planting additional trees along the border of the site to reduce the visual impacts of additional waste disposal cells. Areas with disturbed soils would be seeded with grass upon completion of construction. Windblown litter would be reduced by daily cover in the waste disposal cells and would be cleaned up regularly as part of the WDG operations, which would increase aesthetics of the site.

5.0 RESIDUAL AND CUMULATIVE EFFECTS

Residual environmental effects remaining after the application of mitigation measures, to the extent possible expressed in quantitative terms relative to baseline conditions

No negative residual effects are anticipated through the WDG upgrade and expansion construction and operation, due to the mitigation measures described above. Positive residual effects to the City and RM of Dauphin are expected from the increased waste disposal capacity and composting capabilities, which will allow for continued growth of the service population.

Cumulative effects from other construction projects in the area may occur if the proposed correctional facility, located approximately 1 km from the WDG expansion area, is constructed at the same time as the WDG expansion and upgrade works. This would create cumulative impacts from heavy traffic along Road 147 N, which is the main access route for both sites.

Cumulative effects from operations of several waste disposal cells at once are not expected, as the expansion cells would only be constructed when existing waste disposal cells are nearing capacity, to reduce overlap of cell use.

6.0 MONITORING AND FOLLOW-UP

Proposed follow-up activities that will be required at any stage of development (eg. Monitoring, inspection, surveillance, audit, etc.)

The expansion cell, compost pad and leachate retention pond liners would be inspected and tested in the presence of Manitoba Conservation, upon completion of construction works and prior to commissioning. The liners would be tested for hydraulic conductivity to ensure that the requirements of the Environment Act Licence are met. Long-term monitoring on the WDG site would include annual testing of the groundwater monitoring wells for water quality parameters described in the Environment Act Licence. The operator is also to ensure that the liquid level in the compost retention pond is maintained at an acceptable height, so that the freeboard is maintained and liquid does not overflow the cell. The operator is also to maintain records of type and quantity of waste received at the site. If there are any concerns with the operation of the WDG or with possible groundwater contamination, the City of Dauphin is to contact the local environment officer and the Environmental Approvals Branch of Manitoba Conservation to discuss options. The construction contractor is to ensure that grass growth occurs on slopes and disturbed areas, after the construction activities are completed.

7.0 FUNDING AND APPROVALS

Name and address of any Government Agency or program (federal, provincial or otherwise) from which a grant or loan of capital funds have been requested (where applicable). Other federal, provincial or municipal approvals, licences, permits, authorizations, etc. known to be required for the proposed development, and the status of the project's application or approval.

Funding for this project would be provided by the City of Dauphin. Approval for expansion may be required from the Dauphin Regional Airport Authority for construction works within 8 km of the active airport strip. Variances from Manitoba Conservation and Water Stewardship would be required for setback distances to a surface water body and public road or railway right of way, as described in Section 2.5.3 above. During the construction works, Manitoba Hydro and MTS will need to be contacted to notify of the proposed works and to locate any buried utility lines. No additional approvals, licences or permits, beyond the Environment Act Licence, are expected for the WDG upgrade and expansion construction and operation.

8.0 PUBLIC CONSULTATION

Results of any public consultations undertaken or to be undertaken in conjunction with project planning.

Public consultation by the City of Dauphin through a designated public forum, has not been conducted to date for the residents in the City or RM of Dauphin, as funding for the project has not yet been established. Public comments received by Manitoba Conservation through the public registry during the Environmental Act Proposal review period will be addressed prior to the WDG upgrade and expansion works.

9.0 CONCLUSION

Based on the design of the project and the implementation of the mitigation measures identified in Section 4.0 above, no significant negative environmental impacts are anticipated.

The proponent would like to complete the requirements of the Environment Act Proposal as soon as possible so that the WDG upgrade and construction works can begin in a timely manner.

JR Cousin Consultants Ltd. requests that a draft copy of the Environment Act Licence be forwarded for review prior to the issue of the final licence.

APPENDICES

Appendix A

Certificate of Title

Crown Lands & Property Agency - Lands Branch, March 11, 2015 Email Correspondence

Appendix B

Table 1: Population and Waste Generation Projections – City of Dauphin Waste Disposal Ground

Manitoba Conservation and Water Stewardship - Wildlife and Ecosystem Protection Branch, March 23, 2015 Email Correspondence

Manitoba Tourism, Culture, Heritage, Sport and Consumer Protection - Historic Resources Branch, April 4, 2015 Memorandum

Appendix C

Test Hole Logs

Stantec Consulting Ltd. Soils Analysis Report, August 26, 2014

Stantec Consulting Ltd. Soils Analysis Report, October 6, 2014

Driller's Well Logs

Appendix D

Title Page

Plan 1: Site Location Plan with Required Setbacks and Drainage Route

Plan 2: WDG Upgrade and Expansion Site with Test hole Location Plan

Plan 3: Proposed Expansion and Upgrade Layout and Drainage Plan

Plan 4: Dike and Liner Details

Plan 5: Road, Ditch, Fence, Sten Log and Sign Details

Appendix A

Certificate of Title

Crown Lands & Property Agency - Lands Branch, March 11, 2015 Email Correspondence

Certificate of Title

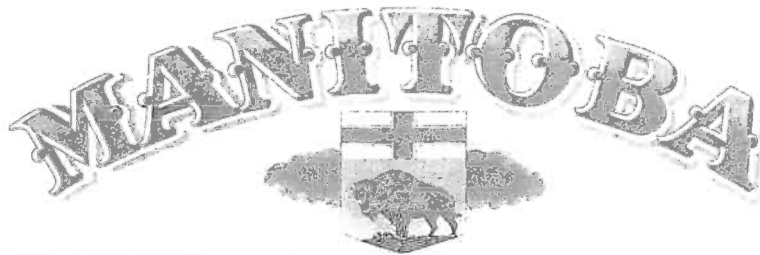

Cert. No. 124690

Certificate of Title

UNDER "THE REAL PROPERTY ACT"

THE TOWN OF DAUPHIN

is now seized of an estate in fee simple in possession subject to such encumbrances, liens and interests as are notified by memorandum underwritten (or endorsed hereon) in all that piece or parcel of land known and described as follows,

All that portion of the South-West Quarter of Section Twenty, in the Twenty-fifth Township and Nineteenth Range, West of the Principal Meridian in Manitoba, lying to the south and west of the right-of-way of The Canadian Northern Railway, which right-of-way is shown on a Plan registered in the Dauphin Land Titles Office as No. 247, excepting that portion lying to the north of the southern limit of the right-of-way of The Canadian Northern Railway, which right-of-way is shown on a Plan registered in the said Office as No. 306. Subject to the reservations and provisoes contained in the Grant from the Crown. _____

IN WITNESS WHEREOF I have hereunto signed my name and

affixed my Seal of office this fifteenth day of December

One thousand nine hundred and Eighty-one.

Signed in the presence of

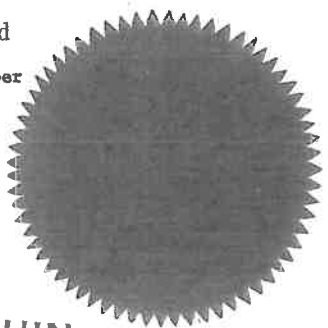

Margaret Phillips }

B. Howard
District Registrar

for **DAUPHIN**

(U) Public highways, easements in fee appurtenant to the land included in a certificate shall be deemed to be excluded unless the certificate is to the Crown or a municipality.
(m) Any zoning regulation as that expression is defined in the Aeronautics Act (CANADA) made under that act and deposited in the Land Titles Office.

Crown Lands & Property Agency - Lands Branch, March 11, 2015 Email Correspondence

Oswald Wohlgemut

From: Little, Karen (CLPA) [Karen.Little@gov.mb.ca]
Sent: Wednesday, March 11, 2015 8:28 AM
To: 'Oswald Wohlgemut'
Subject: RE: Dauphin WDG - Mineral Rights SW 20-25-19 WPM

Good morning Oswald – according to The Crown Land Registry this date:

SW 20-25-19 WPM – The Dominion of Canada granted this ¼ section to William Steenson in July 1896 along with the sand & gravel. The Crown kept the mines & minerals.

- Current Certificate of Title 124690 is “*subject to the reservations and provisos contained in the Grant from the Crown*” therefore the sand & gravel remains with this surface title. The Crown continues to own the mines & minerals.

Sincerely,

Karen Little

Supervisor of Crown Lands Registry

Crown Lands and Property Agency
308 - 25 Tupper Street North
Portage la Prairie MB R1N 3K1
P 204-239-3805 F 204-239-3560
Toll Free 1-866-210-9589
karen.little@gov.mb.ca



An Agency of the Manitoba Government

The information contained in this e-mail and all attachments is confidential and is for the sole use of its intended recipient. It may not be disclosed to or used by anyone other than the addressee. If received in error, please contact the sender by return e-mail and delete this e-mail and all attachments from your system.

Le présent courrier électronique (courriel) et les documents qui y sont attachés peuvent contenir de l'information confidentielle; ils s'adressent exclusivement au destinataire mentionné ci-dessus et nulle autre personne ne doit en prendre connaissance ni les utiliser ou les divulguer. Si vous recevez le présent courriel par erreur, veuillez en aviser l'émetteur immédiatement par courrier électronique et le détruire avec les documents qui y sont attachés.

From: Oswald Wohlgemut [<mailto:owohlgemut@jrcc.ca>]
Sent: March-10-15 4:51 PM
To: Little, Karen (CLPA)
Subject: Dauphin WDG - Mineral Rights

Hello Karen,

JR Cousin Consultants Ltd. is submitting an Environmental Act Proposal on behalf of the City of Dauphin, regarding the expansion and upgrade of the waste disposal ground near the City of Dauphin, MB in SW 20-25-19 WPM. We have attached a copy of the certificate of title for the parcel of land proposed in the expansion works. Could you confirm the ownership of the mineral rights?

Let me know if you have any questions.

Thank you,

Appendix B

Table 1: Population and Waste Generation Projections – City of Dauphin Waste Disposal Ground

Manitoba Conservation and Water Stewardship - Wildlife and Ecosystem Protection Branch, March 23,
2015 Email Correspondence

Manitoba Tourism, Culture, Heritage, Sport and Consumer Protection - Historic Resources Branch, April 4,
2015 Memorandum

Table 1: Population and Waste Generation Projections – City of Dauphin Waste Disposal Ground

**TABLE 1
POPULATION AND WASTE GENERATION PROJECTIONS
City of Dauphin Waste Disposal Ground**

Column 1	Column 2	Column 3	Column 4	Column 5	Column 6	Column 7	Column 8	Column 9	Column 10	Column 11
CALENDAR YEAR	PROJECT YEAR	RM OF DAUPHIN RURAL POPULATION	CITY OF DAUPHIN POPULATION	CORRECTIONAL FACILITY POPULATION	TOTAL WASTE GENERATION (RM of Dauphin)	TOTAL WASTE GENERATION (City of Dauphin and Correctional facility)	TOTAL WASTE FOR DISPOSAL	TOTAL WASTE TO DISPOSAL SITE (RM of Dauphin)	TOTAL WASTE TO DISPOSAL SITE (City of Dauphin)	TOTAL WASTE TO DISPOSAL SITE
		(people) 0.0% Growth	(people) 0.87% Growth	(people) 0.0% Growth	0.51 kg/person/day (tonnes / year)	1.68 kg/person/day (tonnes / year)	(tonnes / year)	(m3 / year)	(m3 / year)	(m3 / year)
2011	0	2,200	8,251	50	410	5090	5,500	862	10,716	11,578
2012	0	2,200	8,323	50	410	5134	5,544	862	10,809	11,671
2013	0	2,200	8,395	50	410	5179	5,588	862	10,902	11,764
2014	0	2,200	8,468	50	410	5223	5,633	862	10,997	11,859
2015	1	2,200	8,542	50	410	5269	5,678	862	11,092	11,954
2016	2	2,200	8,616	50	410	5314	5,724	862	11,188	12,050
2017	3	2,200	8,691	50	410	5360	5,770	862	11,284	12,147
2018	4	2,200	8,767	50	410	5406	5,816	862	11,382	12,244
2019	5	2,200	8,843	180	410	5533	5,942	862	11,648	12,510
2020	6	2,200	8,920	180	410	5580	5,990	862	11,748	12,610
2021	7	2,200	8,998	180	410	5628	6,037	862	11,848	12,710
2022	8	2,200	9,076	180	410	5676	6,085	862	11,949	12,811
2023	9	2,200	9,155	180	410	5724	6,134	862	12,051	12,913
2024	10	2,200	9,234	180	410	5773	6,182	862	12,154	13,016
2025	11	2,200	9,315	180	410	5822	6,232	862	12,257	13,119
2026	12	2,200	9,396	180	410	5872	6,281	862	12,362	13,224
2027	13	2,200	9,478	180	410	5922	6,332	862	12,467	13,330
2028	14	2,200	9,560	180	410	5973	6,382	862	12,574	13,436
2029	15	2,200	9,643	180	410	6024	6,433	862	12,681	13,543
2030	16	2,200	9,727	180	410	6075	6,485	862	12,790	13,652
2031	17	2,200	9,812	180	410	6127	6,536	862	12,899	13,761
2032	18	2,200	9,897	180	410	6179	6,589	862	13,009	13,871
2033	19	2,200	9,983	180	410	6232	6,642	862	13,120	13,982
2034	20	2,200	10,070	180	410	6285	6,695	862	13,232	14,094
2035	21	2,200	10,158	180	410	6339	6,749	862	13,345	14,208
2036	22	2,200	10,246	180	410	6393	6,803	862	13,460	14,322
2037	23	2,200	10,335	180	410	6448	6,857	862	13,575	14,437
2038	24	2,200	10,425	180	410	6503	6,913	862	13,691	14,553
2039	25	2,200	10,516	180	410	6559	6,968	862	13,808	14,670

Overall Total (tonnes): 158,254

Overall Totals (m3): 21,554 311,613 333,167

Compaction Rate (City of Dauphin): 475 kg/m3

Compaction Rate (RM of Dauphin): 475 kg/m3

Manitoba Conservation and Water Stewardship - Wildlife and Ecosystem Protection Branch, March 23,
2015 Email Correspondence

Oswald Wohlgemut

From: Friesen, Chris (CWS) [Chris.Friesen@gov.mb.ca]
Sent: Monday, March 23, 2015 1:15 PM
To: 'Oswald Wohlgemut'
Subject: RE: Dauphin Waste Disposal Ground EAP - Species at Risk

Oswald

Thank you for your information request. I completed a search of the Manitoba Conservation Data Centre's rare species database and found no occurrences at this time for your area of interest.

The information provided in this letter is based on existing data known to the Manitoba Conservation Data Centre at the time of the request. These data are dependent on the research and observations of CDC staff and others who have shared their data, and reflect our current state of knowledge. **An absence of data in any particular geographic area does not necessarily mean that species or ecological communities of concern are not present;** in many areas, comprehensive surveys have never been completed. Therefore, this information should be regarded neither as a final statement on the occurrence of any species of concern, nor as a substitute for on-site surveys for species as part of environmental assessments.

Because the Manitoba CDC's Biotics database is continually updated and because information requests are evaluated by type of action, any given response is only appropriate for its respective request. Please contact the Manitoba CDC for an update on this natural heritage information if more than six months pass before it is utilized.

Third party requests for products wholly or partially derived from Biotics must be approved by the Manitoba CDC before information is released. Once approved, the primary user will identify the Manitoba CDC as data contributors on any map or publication using Biotics data, as follows as: Data developed by the Manitoba Conservation Data Centre; Wildlife Branch, Manitoba Conservation and Water Stewardship.

This letter is for information purposes only - it does not constitute consent or approval of the proposed project or activity, nor does it negate the need for any permits or approvals required by the Province of Manitoba.

We would be interested in receiving a copy of the results of any field surveys that you may undertake, to update our database with the most current knowledge of the area.

If you have any questions or require further information please contact me directly at (204) 945-7747.

Chris Friesen
Coordinator
Manitoba Conservation Data Centre
204-945-7747
chris.friesen@gov.mb.ca
<http://www.gov.mb.ca/conservation/cdc/>

From: Oswald Wohlgemut [<mailto:owohlgemut@jrcc.ca>]
Sent: March-16-15 2:30 PM
To: Friesen, Chris (CWS)
Subject: Dauphin Waste Disposal Ground EAP - Species at Risk

Hello Chris,

J.R. Cousin Consultants is conducting an Environment Act Proposal on behalf of the City of Dauphin for the upgrade and expansion of the existing waste disposal ground. The construction works will occur on SW 20-25-19 WPM (see attached plan). The site is cleared grass land, so no tree removal will be required for the construction works. The site is surrounded by agricultural land and bordered to the south by Road 147 N and to the east and north by a CN Railway

Line. Works will include expansion cell construction, compost pad construction, leachate pond construction, fence installation and ditch construction.

Please provide information on any at risk wildlife and plant species that are known to exist in the locations outlined above, as well as any registered habitat areas, or known migrating bird species as we would like to include that information in the Environmental Screening Report.

Please let us know if you have any questions.

Thank you,

Oswald Wohlgemut, M.Sc.
Environmental Scientist

J.R. Cousin Consultants Ltd.
Phone: (204) 489-0474
Fax: (204) 489-0487
www.jrcc.ca

The information contained in this email and any attachments is privileged, confidential and subject to copyright. It is intended solely for the use of the person(s) to whom it is addressed. If you receive this email in error, please notify the sender by return email and permanently delete it from your system. Note: We have taken precautions against viruses, but take no responsibility for loss or damage caused by any virus present.

Manitoba Tourism, Culture, Heritage, Sport and Consumer Protection - Historic Resources Branch, April 4,
2015 Memorandum

DATE: April 4, 2015

TO: Oswald Wohlgemut
Environmental Scientist
J.R. Cousin Consultants Ltd.
owohlgemut@jrcc.ca

FROM: Christina Nesbitt
Impact Assessment
Archaeologist
Historic Resources Branch
Main Floor 213 Notre Dame
Avenue
Winnipeg MB
R3B 1N3
Christina.Nesbitt@gov.mb.ca
PHONE NO: (204) 945-8145

SUBJECT: Dauphin Waste Disposal Ground
SW 20-25-19 W
Cell construction, lagoon, perimeter ditch, fence
HRB Screening Results

HRB FILE: AAS-14-9079

Further to your memo requesting a heritage screening for the above expansion of the Dauphin waste disposal ground directly east of the current disposal ground in SW 20-25-19 W (Planned Area), the Historic Resources Branch (HRB) has examined the applicable areas proposed for development in conjunction with the Branch's records for areas of potential concern, and can advise you that there are no previously recorded heritage site(s) located in the Planned Area and therefore HRB has no concerns with the project at this time.

However, please be advised that if any heritage resources are encountered in association with the Planned Area during development, the Developer is required to notify HRB and HRB may require that a heritage resource management strategy be implemented to mitigate the effects of development on the heritage resources.

If you have any questions or comments, please feel free to contact the undersigned at the above noted address, phone number, or e-mail.

Christina Nesbitt

Appendix C

Test Hole Logs

Stantec Consulting Ltd. Soils Analysis Report, August 26, 2014

Stantec Consulting Ltd. Soils Analysis Report, October 6, 2014

Driller's Well Logs

Test Hole Logs

J. R. Cousin Consultants Ltd.
TEST HOLE LOGS

SYMBOL INDEX



GW. : Well graded gravels and gravel sand mixtures, little or no fines



GP. : Poorly graded gravels, gravel - sand mixtures,
little or no fines



GM. : Silty gravels, gravel-sand-silt mixtures



GC. : Clayey gravels, gravel-sand-clay mixtures



SW. : Well graded sands, gravelly sands, little or no fines



SP. : Poorly graded sands, or gravelly sands, little or no fines



SM. : Silty sands, sand-silt mixtures



SC. : Clayey sands, sand-clay mixtures



ML. : Inorganic silts and very fine sands, rock flour, silty or clayey fine sands,
or clayey silts with slight plasticity



CL. : Inorganic clays of low plasticity, gravelly clays, sandy or silty
clays, lean clays



OL. : Organic silts and organic silty clays of low plasticity



CI. : Inorganic clays of medium or intermediate plasticity



MH. : Inorganic silts, fine sandy or silty soils



CH. : Inorganic clays of high plasticity, fat clays



OH. : Organic clays of medium to high plasticity, organic silts



Pt. : Peat, humus, swamp soils with high organic contents



TOPSOIL

The soil logs are based upon objective data available to us at the time of forming our opinions. The soil logs indicate site specific soil characteristics and must not be generalized over larger areas due to the limited number of test holes as compared to that of an unlimited number of test holes. Every effort is made to evaluate the information by methods generally recognized. The soil logs represent our opinions. J. R. Cousin Consultants Ltd. cannot be responsible for actual site conditions proved to be materially at variance from our analysis or from the data generalization over untested areas.

J. R. Cousin Consultants Ltd.







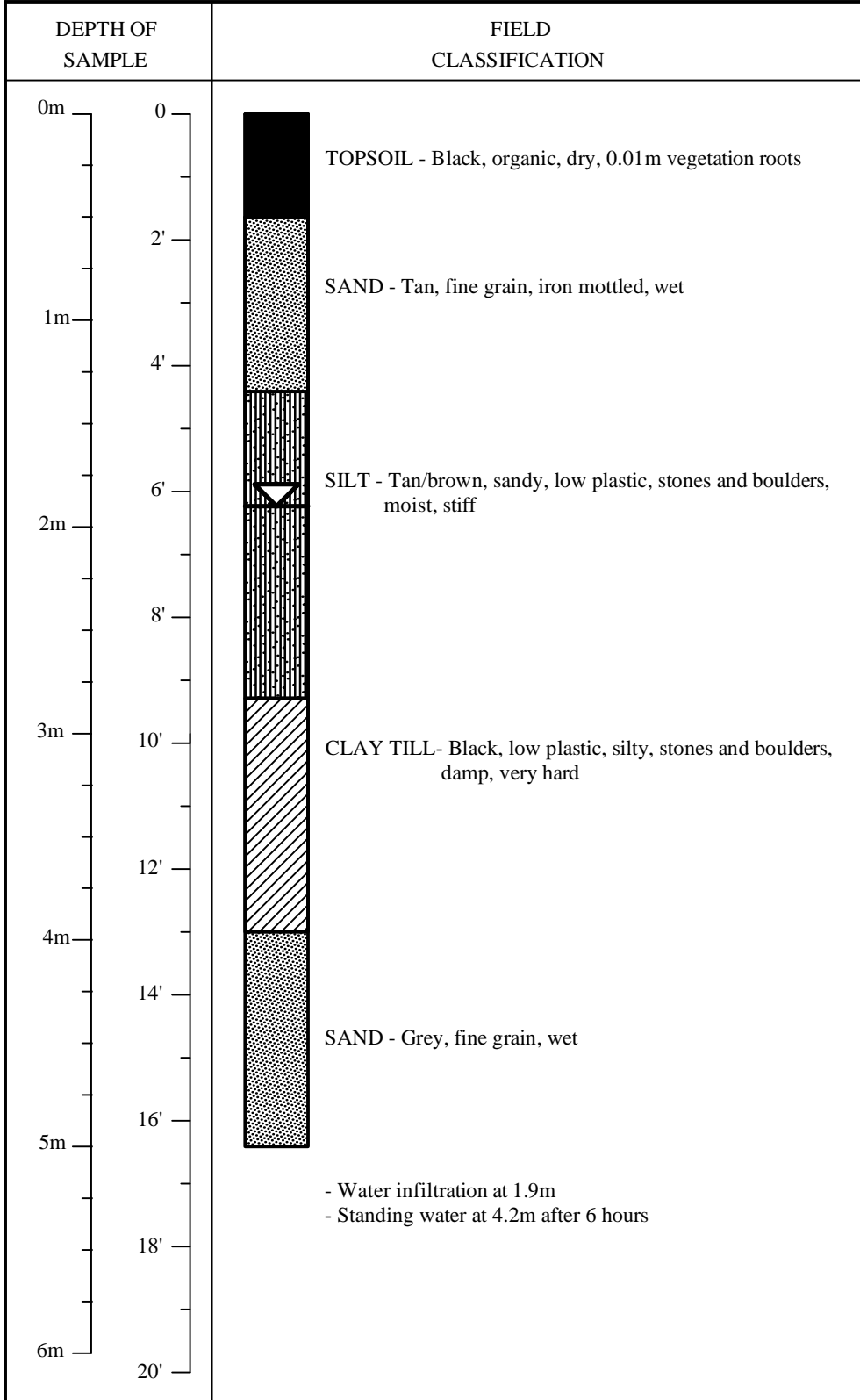

TEST HOLE LOG SHEET

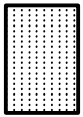
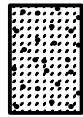
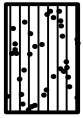
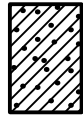
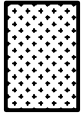
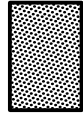
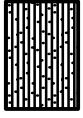
LOCATION : Dauphin Waste Disposal Ground
 COORDINATES : N 5669314, E 422690
 PROJECT : Dauphin Disposal Ground Expansion

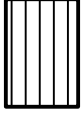
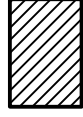
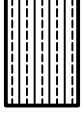
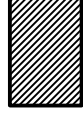
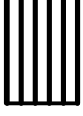
CODE : D-587.06
 ELEVATION : 296.881m
 METHOD OF SAMPLING : Backhoe

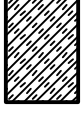
DATE : July 31, 2014
 TEST HOLE # 1



	
GW	GP
	
GM	GC
	
SW	SP
	
SM	SC
	
ML	CL
	
OL	CI
	
MH	CH
	
OH	PT
	
Topsoil	Infiltration Water Level

The soil logs are based upon objective data available to us at the time of forming our opinions. The soil logs indicate site specific soil characteristics and must not be generalized over larger areas do to the limited number of test holes as compared to that of an unlimited number of test holes. Every effort is made to evaluate the information by methods generally recognized. The soil represent our opinions. J.R. Cousin Consultants Ltd. cannot be responsible for actual site conditions proved to be materially at variance from our analysis or from the data generalization over untested areas.

J. R. Cousin Consultants Ltd.









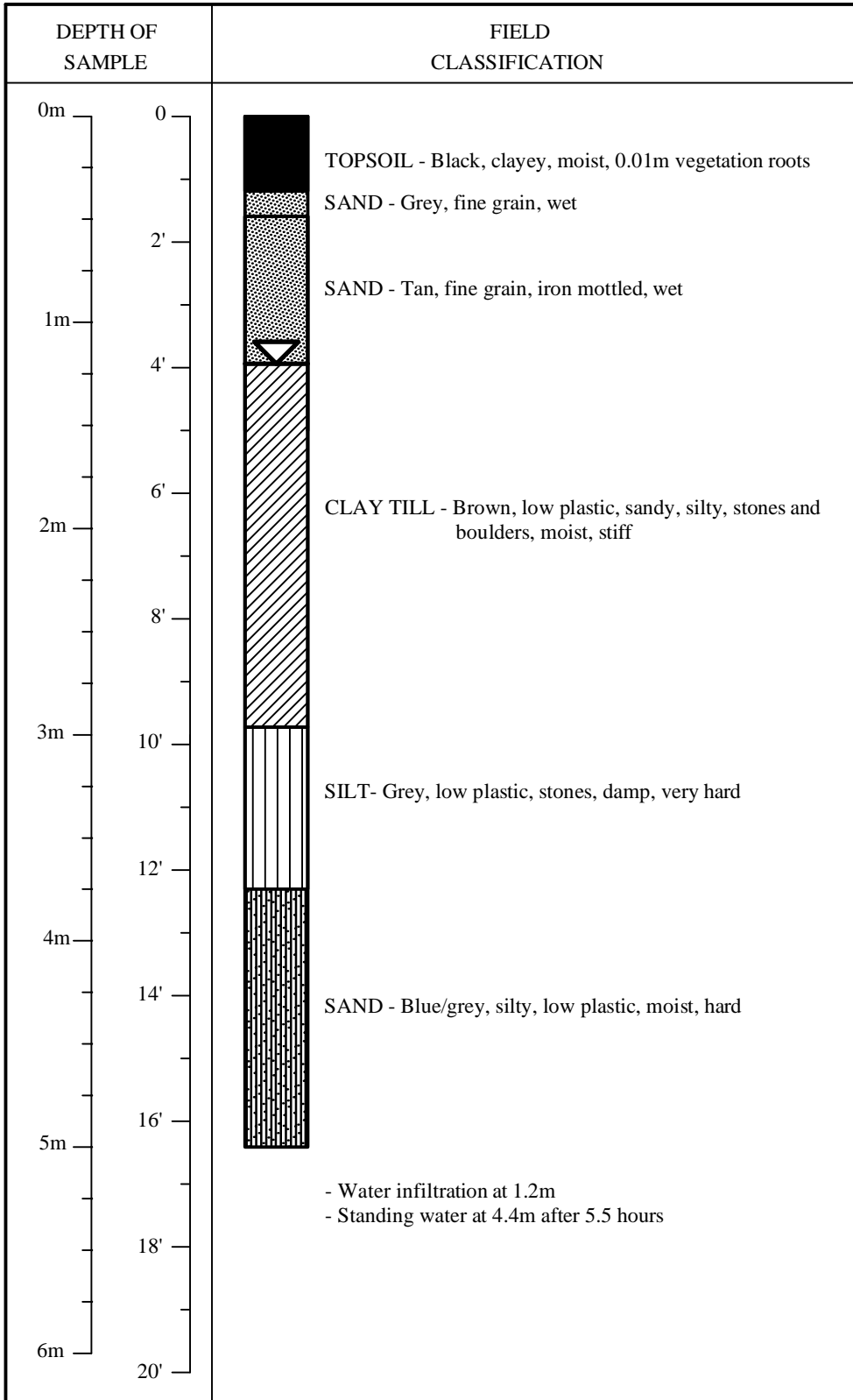

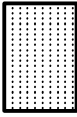
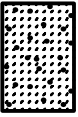
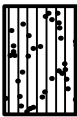
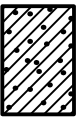

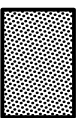
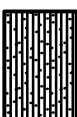
TEST HOLE LOG SHEET

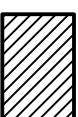
LOCATION : Dauphin Waste Disposal Ground
 COORDINATES : N 5669333, E 422786
 PROJECT : Dauphin Disposal Ground Expansion

CODE : D-587.06
 ELEVATION : 295.765m
 METHOD OF SAMPLING : Backhoe

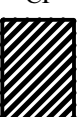
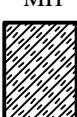
DATE : July 31, 2014
 TEST HOLE # 2



	
GW	GP
	
GM	GC
	
SW	SP
	
SM	SC
	
ML	CL
	
OL	CI
	
MH	CH
	
OH	PT
	
Topsoil	Infiltration Water Level

The soil logs are based upon objective data available to us at the time of forming our opinions. The soil logs indicate site specific soil characteristics and must not be generalized over larger areas do to the limited number of test holes as compared to that of an unlimited number of test holes. Every effort is made to evaluate the information by methods generally recognized. The soil represent our opinions. J.R. Cousin Consultants Ltd. cannot be responsible for actual site conditions proved to be materially at variance from our analysis or from the data generalization over untested areas.

J. R. Cousin Consultants Ltd.

TEST HOLE LOG SHEET

LOCATION : Dauphin Waste Disposal Ground
 COORDINATES : N 5669367, E 422821
 PROJECT : Dauphin Disposal Ground Expansion

CODE : D-587.06
 ELEVATION : 295.629m
 METHOD OF SAMPLING : Backhoe

DATE : July 31, 2014
 TEST HOLE # 3

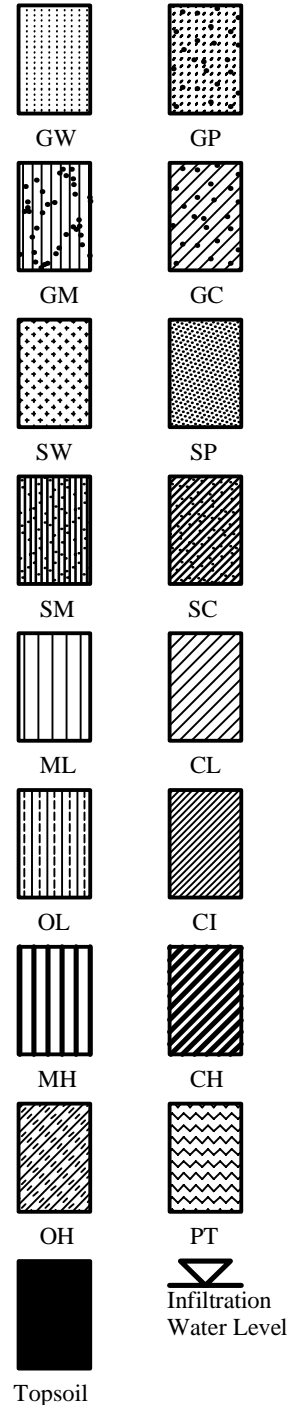
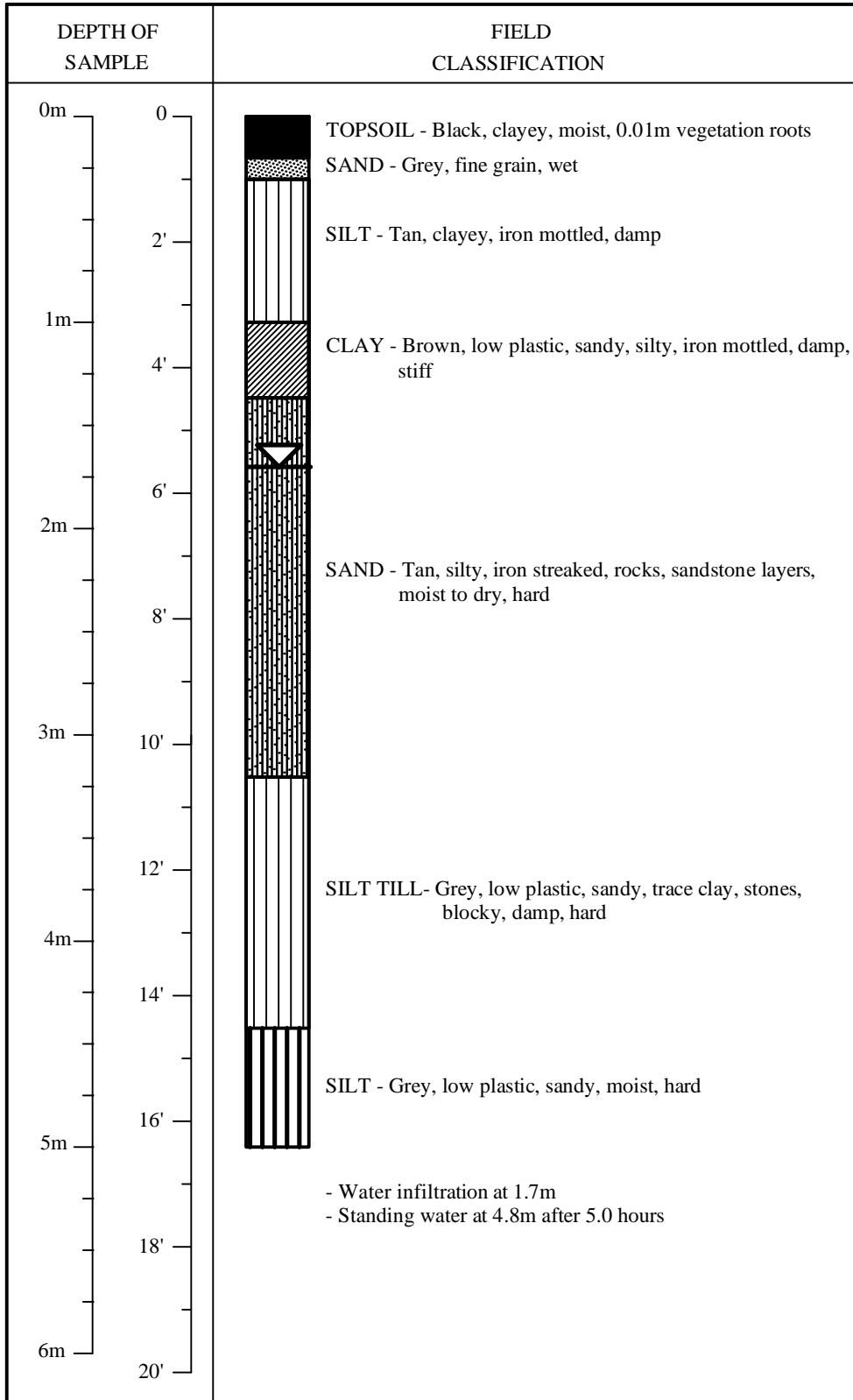

The soil logs are based upon objective data available to us at the time of forming our opinions. The soil logs indicate site specific soil characteristics and must not be generalized over larger areas do to the limited number of test holes as compared to that of an unlimited number of test holes. Every effort is made to evaluate the information by methods generally recognized. The soil represent our opinions. J.R. Cousin Consultants Ltd. cannot be responsible for actual site conditions proved to be materially at variance from our analysis or from the data generalization over untested areas.

J. R. Cousin Consultants Ltd.

TEST HOLE LOG SHEET

LOCATION : Dauphin Waste Disposal Ground
 COORDINATES : N 5669328, E 422969
 PROJECT : Dauphin Disposal Ground Expansion

CODE : D-587.06
 ELEVATION : 295.225m
 METHOD OF SAMPLING : Backhoe

DATE : July 31, 2014
 TEST HOLE # 4

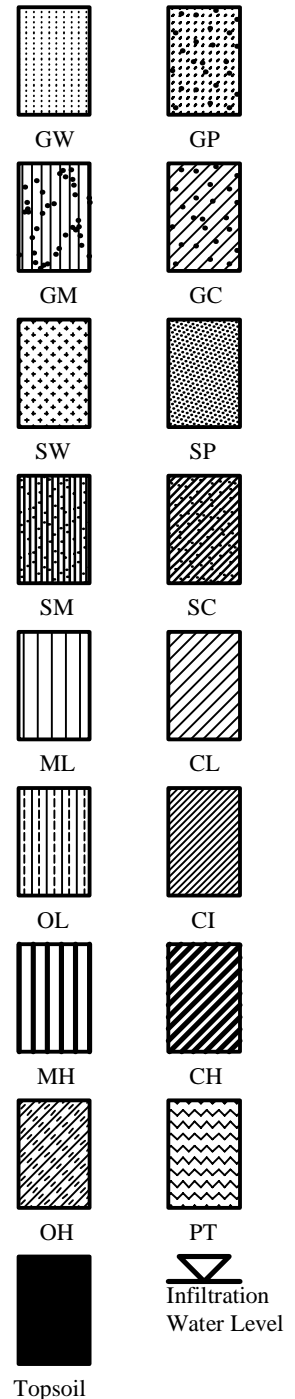
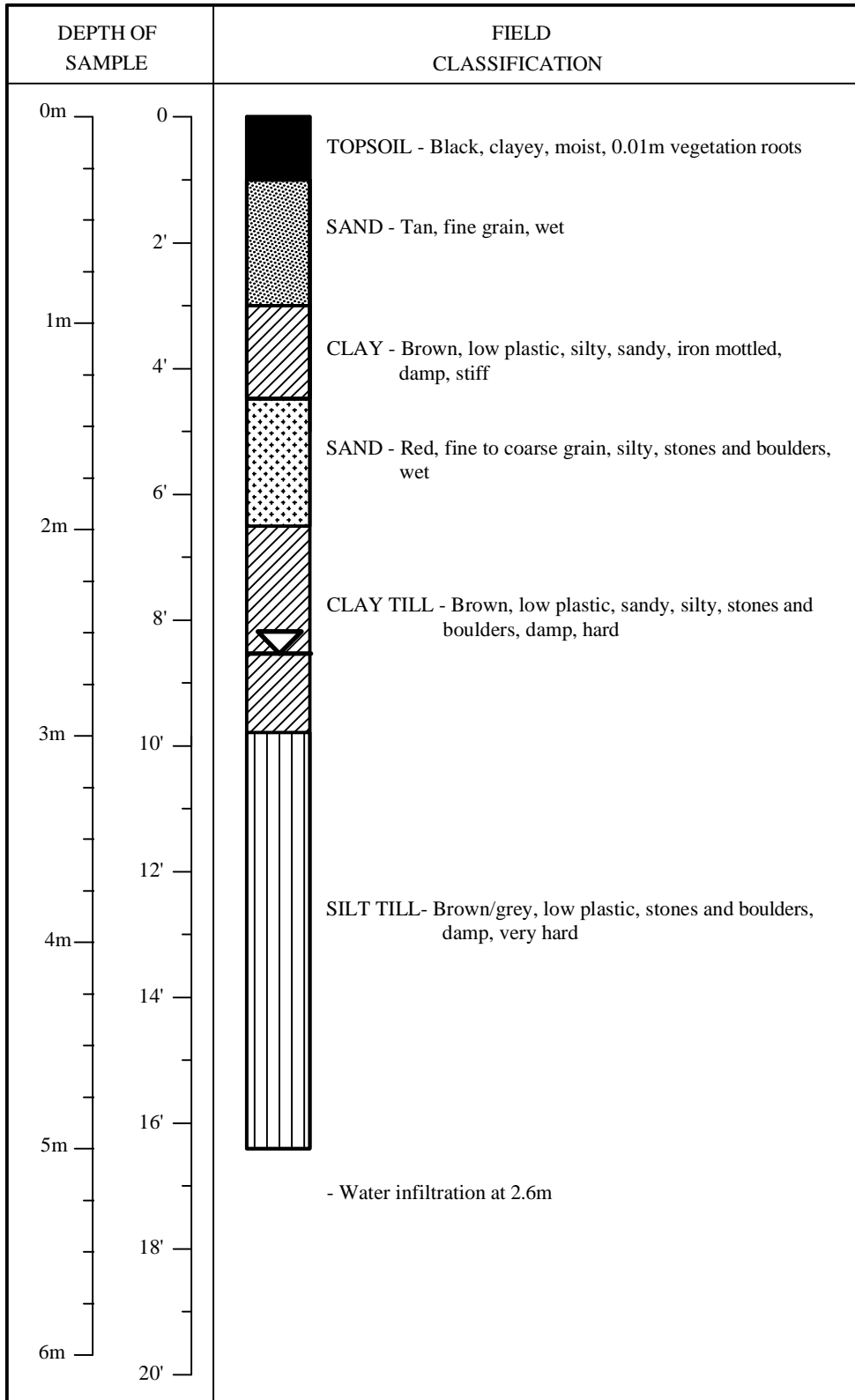

The soil logs are based upon objective data available to us at the time of forming our opinions. The soil logs indicate site specific soil characteristics and must not be generalized over larger areas do to the limited number of test holes as compared to that of an unlimited number of test holes. Every effort is made to evaluate the information by methods generally recognized. The soil represent our opinions. J.R. Cousin Consultants Ltd. cannot be responsible for actual site conditions proved to be materially at variance from our analysis or from the data generalization over untested areas.

J. R. Cousin Consultants Ltd.

TEST HOLE LOG SHEET

LOCATION : Dauphin Waste Disposal Ground
 COORDINATES : N 5669313, E 423159
 PROJECT : Dauphin Disposal Ground Expansion

CODE : D-587.06
 ELEVATION : 294.837m
 METHOD OF SAMPLING : Backhoe

DATE : July 31, 2014
 TEST HOLE # 5

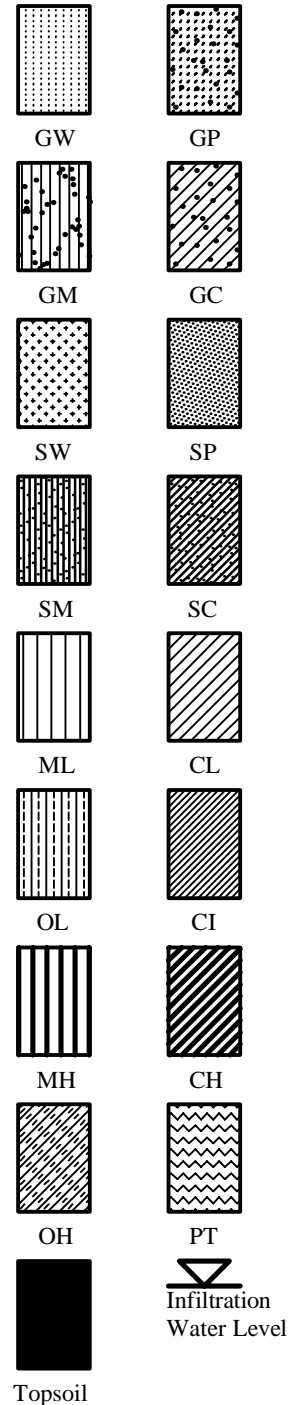
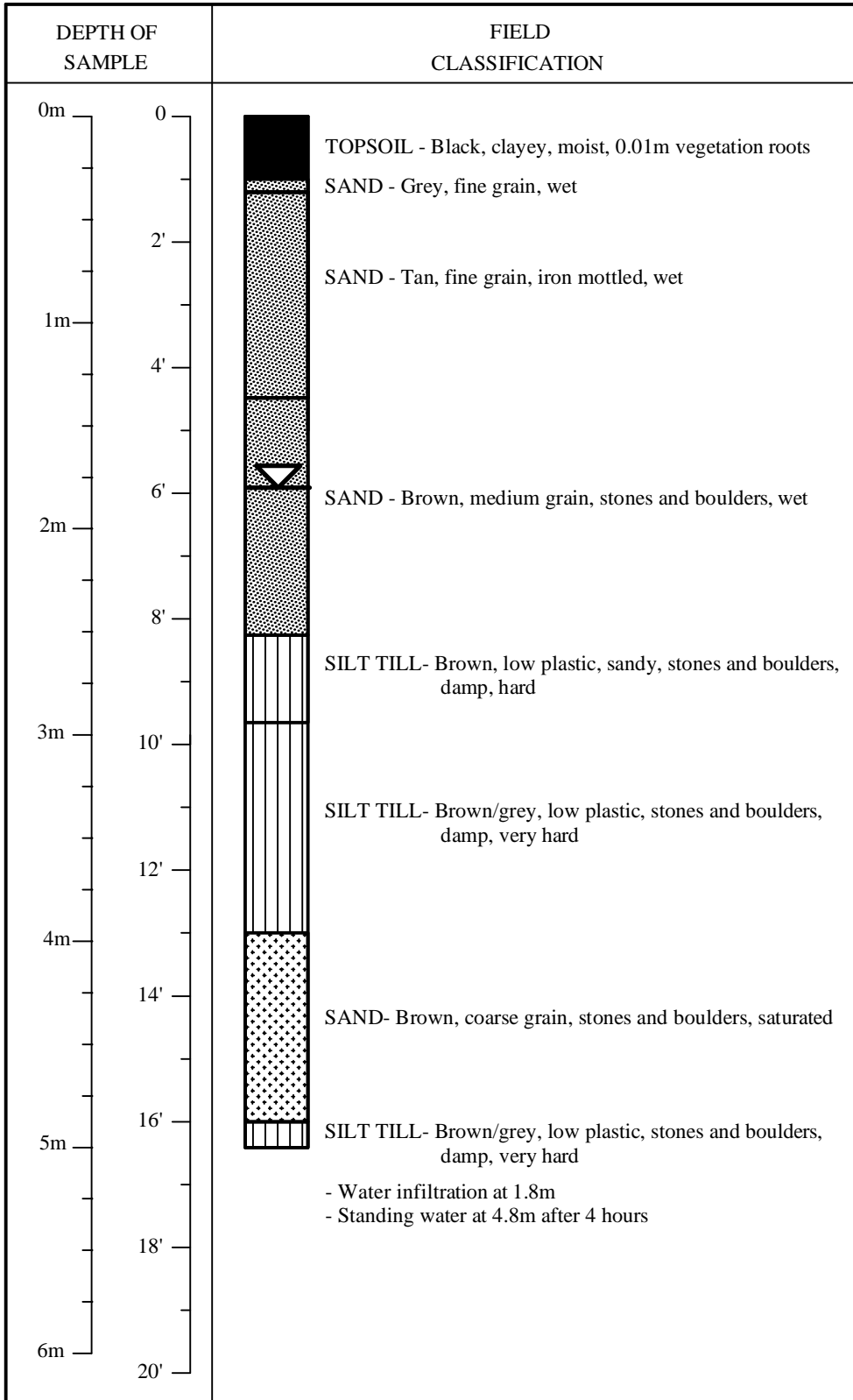

The soil logs are based upon objective data available to us at the time of forming our opinions. The soil logs indicate site specific soil characteristics and must not be generalized over larger areas do to the limited number of test holes as compared to that of an unlimited number of test holes. Every effort is made to evaluate the information by methods generally recognized. The soil represent our opinions. J.R. Cousin Consultants Ltd. cannot be responsible for actual site conditions proved to be materially at variance from our analysis or from the data generalization over untested areas.

J. R. Cousin Consultants Ltd.

TEST HOLE LOG SHEET

LOCATION : Dauphin Waste Disposal Ground
 COORDINATES : N 5669464, E 423167
 PROJECT : Dauphin Disposal Ground Expansion

CODE : D-587.06
 ELEVATION : 294.596m
 METHOD OF SAMPLING : Backhoe

DATE : July 31, 2014
 TEST HOLE # 6

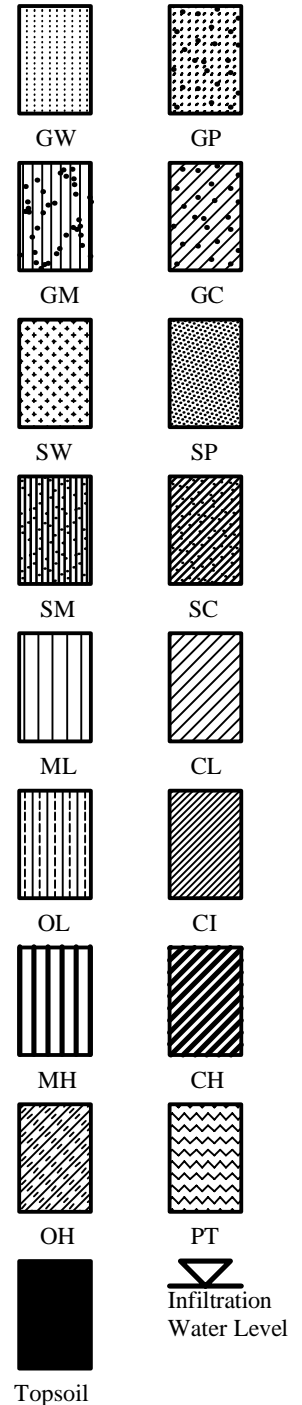
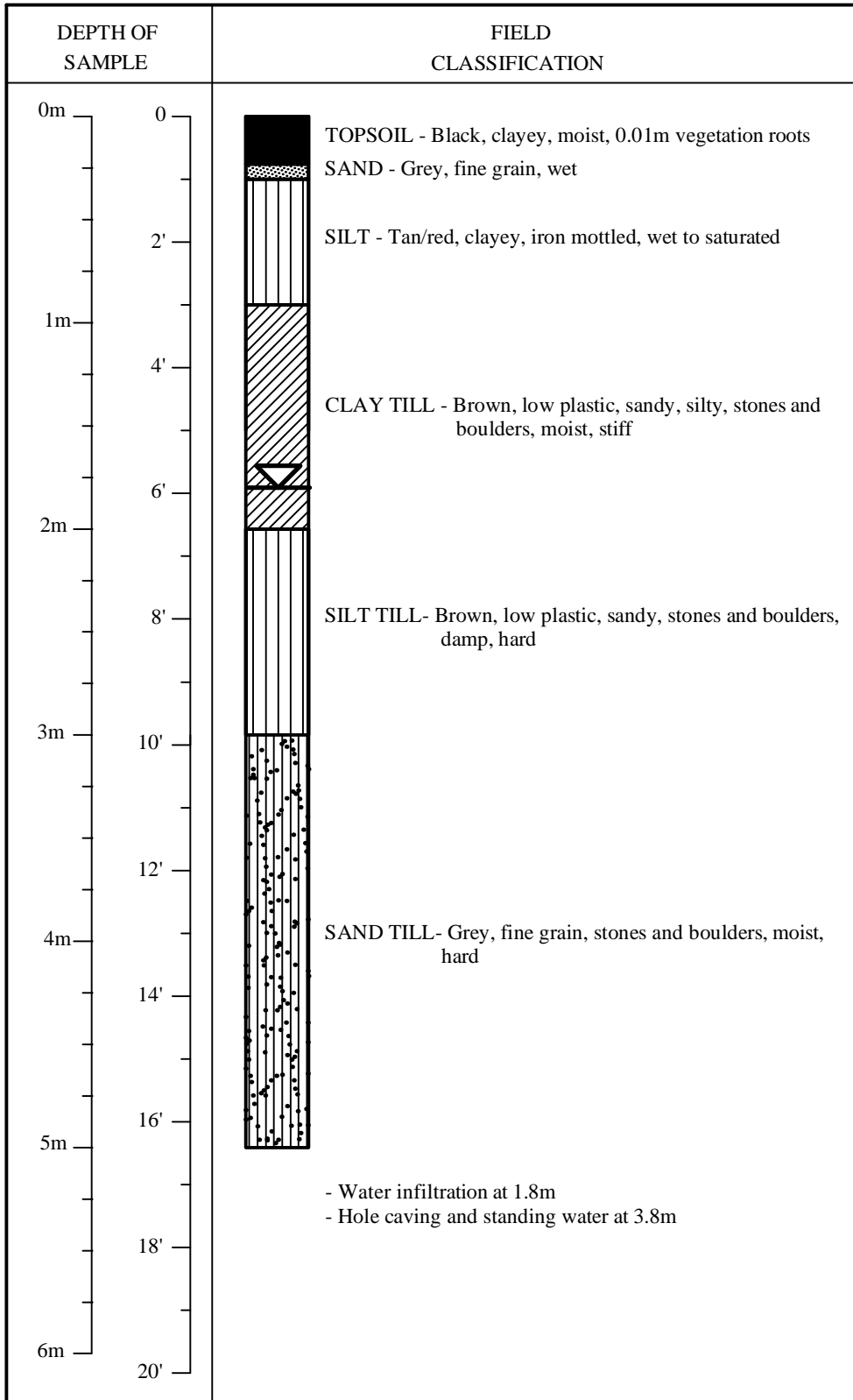

The soil logs are based upon objective data available to us at the time of forming our opinions. The soil logs indicate site specific soil characteristics and must not be generalized over larger areas do to the limited number of test holes as compared to that of an unlimited number of test holes. Every effort is made to evaluate the information by methods generally recognized. The soil represent our opinions. J.R. Cousin Consultants Ltd. cannot be responsible for actual site conditions proved to be materially at variance from our analysis or from the data generalization over untested areas.

J. R. Cousin Consultants Ltd.

TEST HOLE LOG SHEET

LOCATION : Dauphin Waste Disposal Ground
 COORDINATES : N 5669493, E 423042
 PROJECT : Dauphin Disposal Ground Expansion

CODE : D-587.06
 ELEVATION : 294.794m
 METHOD OF SAMPLING : Backhoe

DATE : July 31, 2014
 TEST HOLE # 7

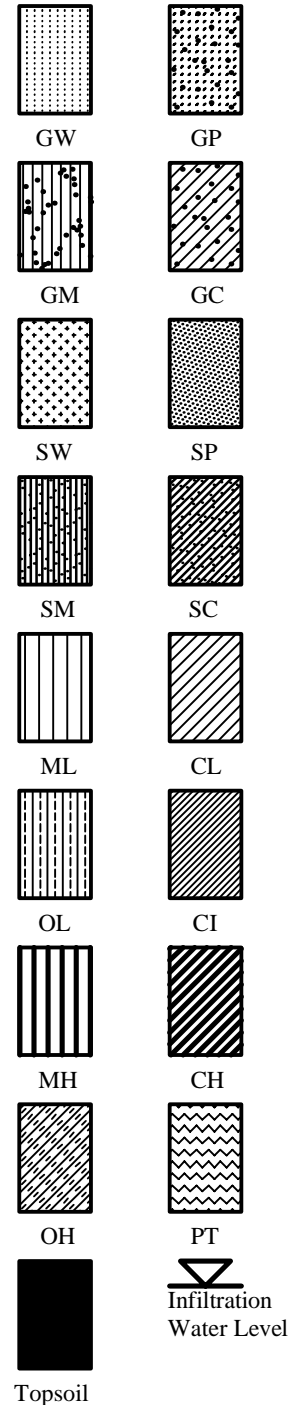
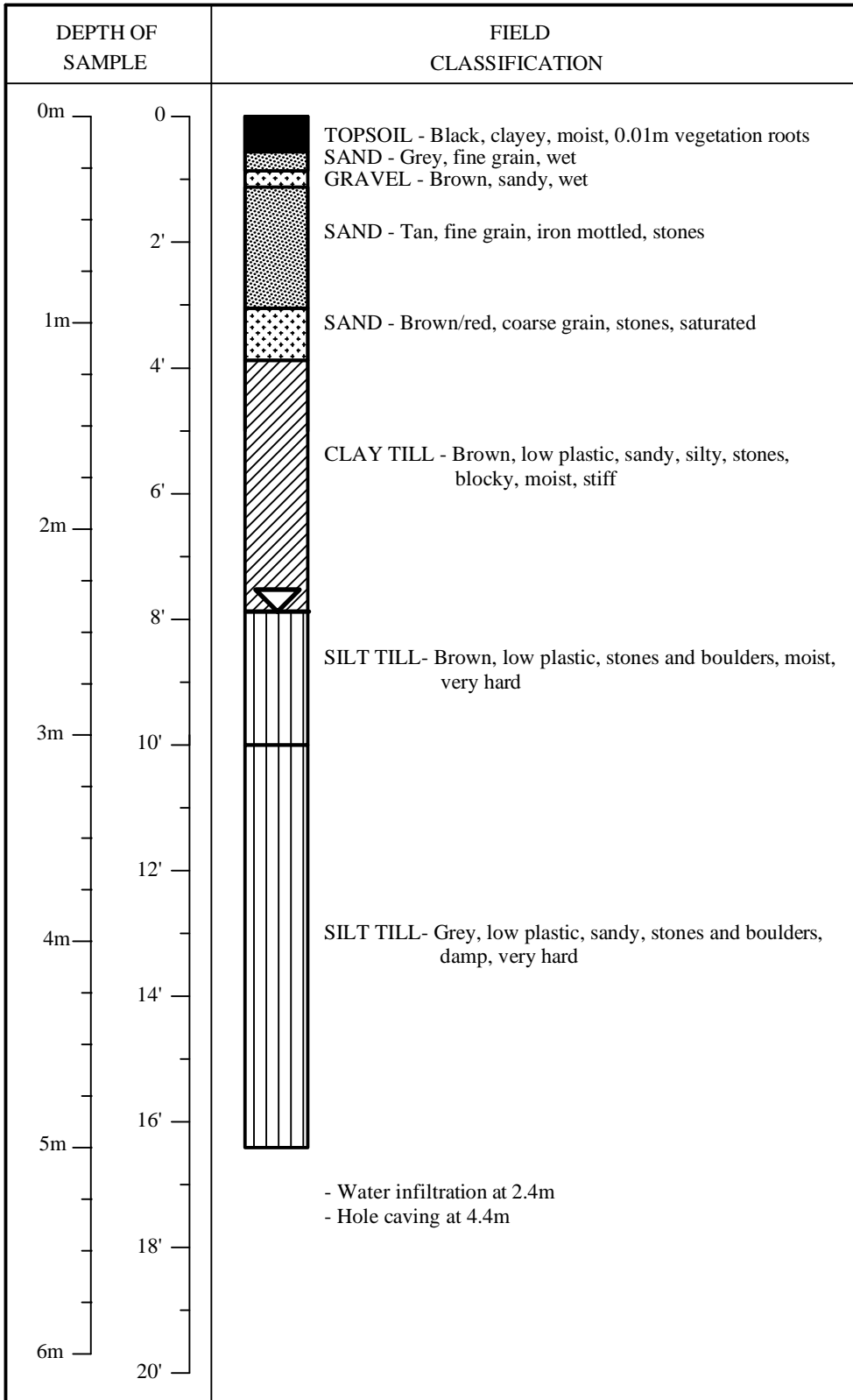

The soil logs are based upon objective data available to us at the time of forming our opinions. The soil logs indicate site specific soil characteristics and must not be generalized over larger areas do to the limited number of test holes as compared to that of an unlimited number of test holes. Every effort is made to evaluate the information by methods generally recognized. The soil represent our opinions. J.R. Cousin Consultants Ltd. cannot be responsible for actual site conditions proved to be materially at variance from our analysis or from the data generalization over untested areas.

J. R. Cousin Consultants Ltd.

TEST HOLE LOG SHEET

LOCATION : Dauphin Waste Disposal Ground
 COORDINATES : N 5669640, E 422967
 PROJECT : Dauphin Disposal Ground Expansion

CODE : D-587.06
 ELEVATION : 294.700m
 METHOD OF SAMPLING : Backhoe

DATE : July 31, 2014
 TEST HOLE # 8

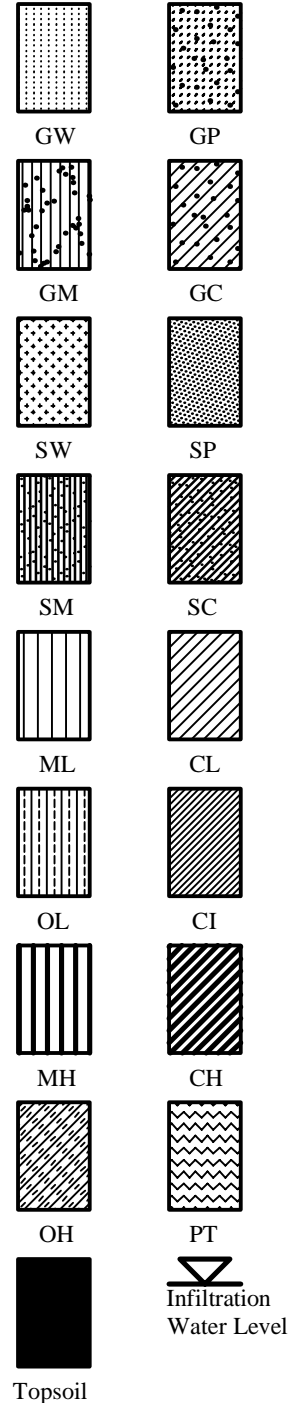
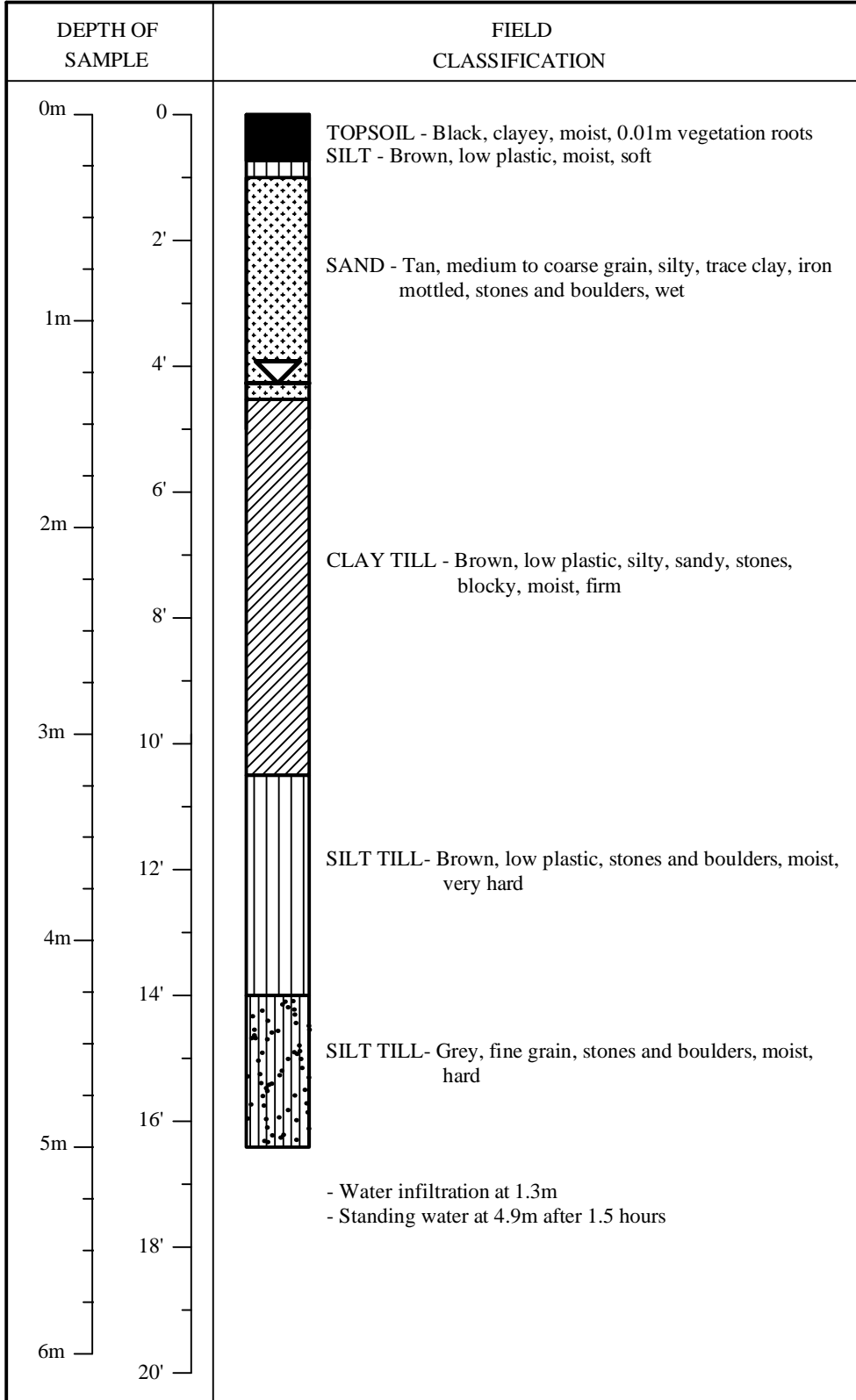

The soil logs are based upon objective data available to us at the time of forming our opinions. The soil logs indicate site specific soil characteristics and must not be generalized over larger areas do to the limited number of test holes as compared to that of an unlimited number of test holes. Every effort is made to evaluate the information by methods generally recognized. The soil represent our opinions. J.R. Cousin Consultants Ltd. cannot be responsible for actual site conditions proved to be materially at variance from our analysis or from the data generalization over untested areas.

J. R. Cousin Consultants Ltd.

TEST HOLE LOG SHEET

LOCATION : Dauphin Waste Disposal Ground
 COORDINATES : N 5669352, E 422726
 PROJECT : Dauphin Disposal Ground Expansion

CODE : D-587.06
 ELEVATION : 298.407m
 METHOD OF SAMPLING : Backhoe

DATE : July 31, 2014
 TEST HOLE # 9

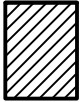
DEPTH OF SAMPLE	FIELD CLASSIFICATION
<div style="display: flex; justify-content: space-between;"> <div style="width: 45%;"> <p>0m</p> <p>1m</p> <p>2m</p> <p>3m</p> <p>4m</p> <p>5m</p> <p>6m</p> </div> <div style="width: 45%;"> <p>0</p> <p>2'</p> <p>4'</p> <p>6'</p> <p>8'</p> <p>10'</p> <p>12'</p> <p>14'</p> <p>16'</p> <p>18'</p> <p>20'</p> </div> </div>	 <p>CLAY FILL - Brown, low plastic, topsoil, stones, dry, covering landfilled material</p>

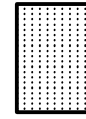

GW

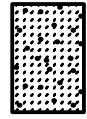

GP



GM

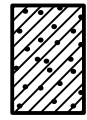

GC



SW

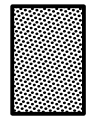

SP



SM

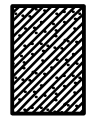

SC

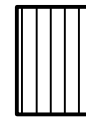

ML

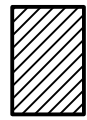

CL



OL

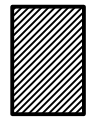

CI

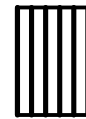

MH



CH



OH



PT



Topsoil



Infiltration
Water Level

The soil logs are based upon objective data available to us at the time of forming our opinions. The soil logs indicate site specific soil characteristics and must not be generalized over larger areas do to the limited number of test holes as compared to that of an unlimited number of test holes. Every effort is made to evaluate the information by methods generally recognized. The soil represent our opinions. J.R. Cousin Consultants Ltd. cannot be responsible for actual site conditions proved to be materially at variance from our analysis or from the data generalization over untested areas.

Stantec Consulting Ltd. Soils Analysis Report, August 26, 2014



Stantec Consulting Ltd.
199 Henlow Bay, Winnipeg MB R3Y 1G4

August 26, 2014
File: 123311458

Attention: Mr. Oswald Wohlgemut

JR Cousin Consultants Ltd.
91A Scurfield Blvd.
Winnipeg, MB R3Y 1G4

Dear Oswald,

Reference: Dauphin Waste Disposal Ground Upgrade/Expansion

Soil samples were submitted to our laboratory on August 19, 2014. The following tests were conducted on selected soil samples:

- Water content (ASTM D2216)
- Particle-Size Analysis (ASTM D422)
- Liquid Limit (one-point), plastic limit, and plasticity index (ASTM D4318)
- Soil Classification (ASTM D2487)
- Visual Classification

The test results for the soil samples are summarized in the following table and in the attached particle size analysis and Atterberg limits reports.

An assessment of the bagged soil samples was conducted to determine whether the soil represented by the bagged samples could be used in-situ as a waste disposal ground liner and would obtain a hydraulic conductivity of less than 1.0×10^{-7} cm/sec without being reworked, and when re-moulded and re-compacted.

Based upon previous testing conducted in our laboratory, homogeneous soil samples with a plasticity index greater than 25 and a clay content greater than 50% will typically have a hydraulic conductivity of 1.0×10^{-7} cm/sec or less. All bagged samples did not fall within this range and considered not suitable to use as a lagoon liner. Our comments regarding the potential use of the material as a liner are based upon the soil being homogeneous with no preferential flow paths. It should be noted that estimating the hydraulic conductivity of a soil based upon classification test results (plasticity index and particle size analysis) alone might be misleading if the soil contains layers of sand, silt, or organic material.



August 26, 2014
Mr. Oswald Wohlgemut
Page 2 of 4

Reference: Dauphin Waste Disposal Ground Upgrade/Expansion

We appreciate the opportunity to assist you in this project. Please call if you have any questions regarding this report.

Regards,

STANTEC CONSULTING LTD.

Jason Thompson, CET
Associate - Manager, Materials Testing Services
Phone: (204) 928-4004
Fax: (204) 488-6947
Jason.Thompson@stantec.com

Attachment: Table 1 – Summary of Water Content, Particle Size, Atterberg Limits, Soil
Classification Test Data
8 x Particle Size Analysis Report
4 x Atterberg Limits Report

TABLE 1
SUMMARY OF WATER CONTENT, PARTICLE SIZE, ATTERBERG LIMITS, SOIL CLASSIFICATION
TEST DATA

Testhole	Depth (m)	Visual Classification	Water Content (%)	Gravel (%) 75 to 4.75 mm	Sand (%)			Silt (%) <0.075 to 0.005 mm	Clay (%) <0.005 mm	Liquid Limit	Plastic Limit	Plasticity Index	Soil Classification ASTM D2487	Potential use as a waste disposal ground liner when re-moulded and re-compacted	Potential use as a waste disposal ground liner without being reworked
					Coarse <4.75 to 2.0 mm	Medium <2.0 to 0.425 mm	Fine <0.425 to 0.075 mm								
TH2	1.2-2.9	brown, firm, moist, low plasticity sandy silt, clayey with trace gravel	15.1	6.3	3.4	6.4	21.1	32.4	30.4	23	13	10	CL(Sandy Lean Clay)	No	No
TH2	2.9-3.8	tan, firm, moist, low plasticity sandy silt with some clay	11.4	9.3	3.4	1.9	23.0	43.3	19.1	23	13	10	CL(Sandy Lean Clay)	No	No
TH3	0.0-0.2	black, soft, moist, medium plasticity silty sand, clayey with trace gravel	29.8	3.1	1.9	7.0	31.5	32.8	23.7	46	29	17	ML(Sandy Silt)	No	No
TH3	0.3-1.0	tan, soft, moist, low plasticity clayey silt with trace sand	17.6	0.0	0.0	0.2	3.8	67.2	28.8	26	15	11	CL(Lean Clay)	No	No



Reference: Dauphin Waste Disposal Ground Upgrade/Expansion

TH4	2.0-3.0	tan, firm, moist, low plasticity silty clay, sandy with trace gravel	7.5	3.2	2.8	7.9	17.3	32.0	36.8	20	12	8	CL(Sandy Lean Clay)	No	No
TH7	1.2-2.4	brown, firm, moist, low plasticity clayey silt, sandy with trace gravel	10.4	5.5	3.5	7.6	10.9	37.5	35	23	10	13	CL(Lean Clay with Sand)	No	No
TH7	3.1-5.0	tan, firm, moist, low plasticity silty sand with some clay and trace gravel	7.7	6.7	3.8	8.6	29.2	37.6	14.1	16	12	4	CL-ML(Sandy Silty Clay)	No	No
TH8	0.3-1.4	tan, firm, moist, low plasticity silty sand with some clay and some gravel	18.5	18.2	9.2	14.8	20.4	24.5	12.9	21	16	5	SC-SM(Silty, clayey sand with gravel)	No	No

Notes:

1. The soil samples were air-dried during sample preparation for Atterberg limits and particle size analysis
2. A high speed stirring device was used for 1 minute to disperse the test samples for particle size analysis
3. Atterberg limits conducted in accordance with ASTM D4318 Method B (one-point liquid limit)



LABORATORY
 199 Henlow Bay
 Winnipeg MB R3Y 1G4
 Tel: (204) 488-6999

PARTICLE SIZE ANALYSIS
ASTM D422

JR Cousin Consultants Ltd.
 91A Scurfield Blvd.
 Winnipeg, Manitoba
 R3Y 1G4

PROJECT: Dauphin Waste Disposal
 Ground Upgrade/Expansion

Attention: Oswald Wohlgemut

PROJECT NO.: 123311458

SAMPLED BY: Client
 SAMPLE ID: TH2 @ 1.2 - 2.9 m

DATE RECEIVED: August 19, 2014
 TESTED BY: Sothea Bun

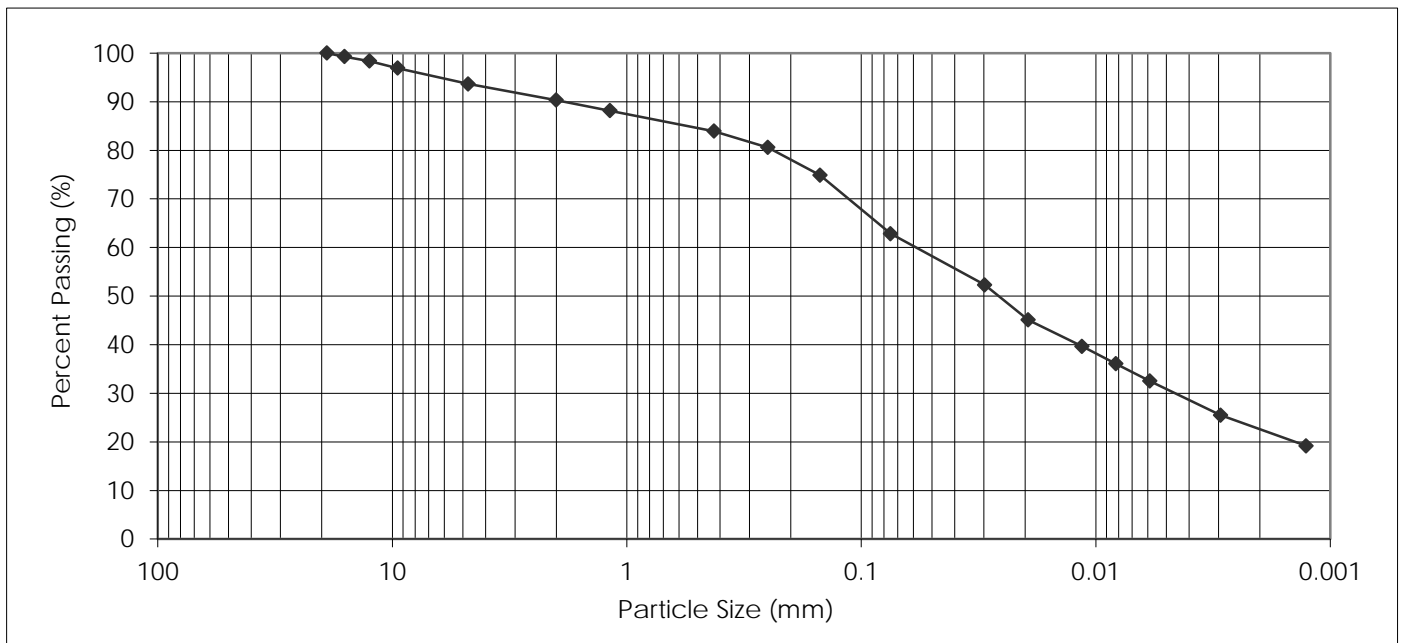

PARTICLE SIZE	PERCENT PASSING	PARTICLE SIZE	PERCENT PASSING
37.50 mm	100.0	1.18 mm	88.2
25.00 mm	100.0	0.425 mm	83.9
19.00 mm	100.0	0.250 mm	80.6
16.00 mm	99.3	0.150 mm	74.9
12.50 mm	98.4	0.075 mm	62.8
9.50 mm	96.9	0.005 mm	30.4
4.75 mm	93.7	0.002 mm	22.0
2.00 mm	90.3	0.001 mm	NT*

Gravel, % 75 to 4.75 mm	Sand, %			Silt, % <0.075 to 0.005 mm	Clay, % <0.005 mm	Colloids, % < 0.001 mm
	Coarse <4.75 to 2.0 mm	Medium <2.0 to 0.425 mm	Fine <0.425 to 0.075 mm			
6.3	3.4	6.4	21.1	32.4	30.4	NT*

NT* Sample not tested for colloids

August 22, 2014

REVIEWED BY:  Jason Thompson, CET



LABORATORY
 199 Henlow Bay
 Winnipeg MB R3Y 1G4
 Tel: (204) 488-6999

**PARTICLE SIZE ANALYSIS
 ASTM D422**

JR Cousin Consultants Ltd.
 91A Scurfield Blvd.
 Winnipeg, Manitoba
 R3Y 1G4

PROJECT: Dauphin Waste Disposal
 Ground Upgrade/Expansion

Attention: Oswald Wohlgemut

PROJECT NO.: 123311458

SAMPLED BY: Client
 SAMPLE ID: TH2 @ 2.9 - 3.8 m

DATE RECEIVED: August 19, 2014
 TESTED BY: Sothea Bun

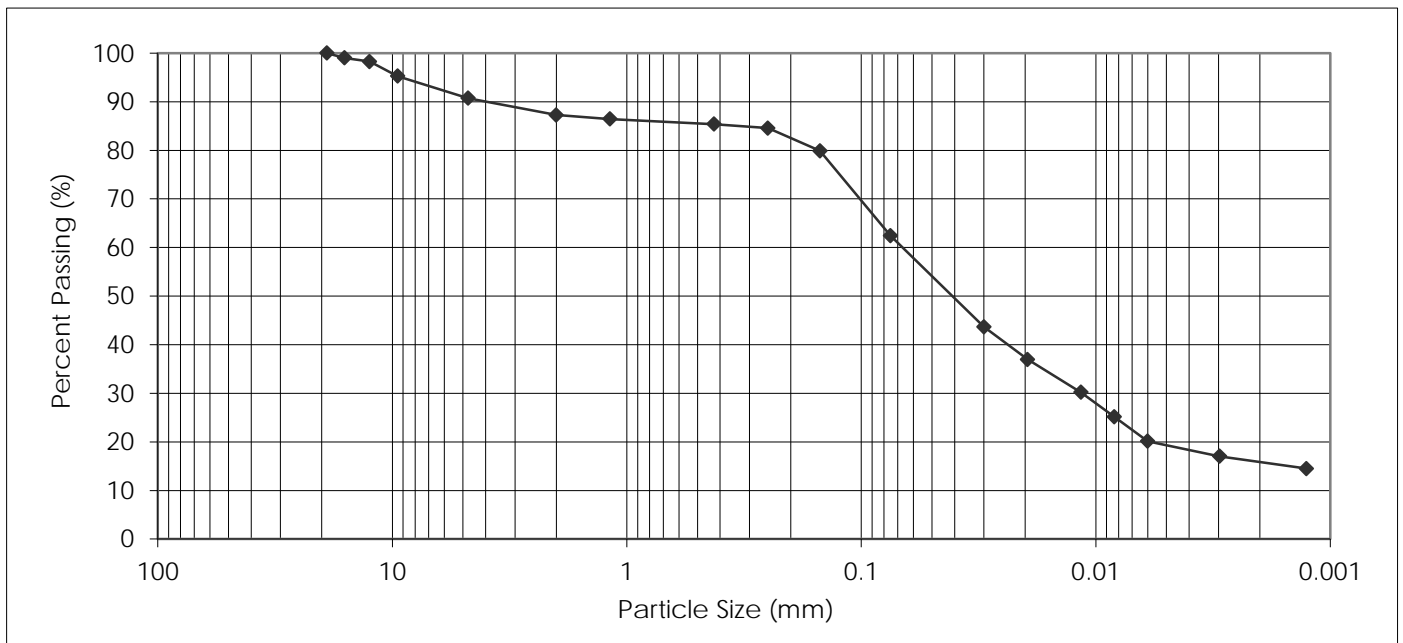

PARTICLE SIZE	PERCENT PASSING	PARTICLE SIZE	PERCENT PASSING
37.50 mm	100.0	1.18 mm	86.5
25.00 mm	100.0	0.425 mm	85.4
19.00 mm	100.0	0.250 mm	84.6
16.00 mm	99.0	0.150 mm	79.9
12.50 mm	98.3	0.075 mm	62.4
9.50 mm	95.3	0.005 mm	19.1
4.75 mm	90.7	0.002 mm	15.6
2.00 mm	87.3	0.001 mm	NT*

Gravel, % 75 to 4.75 mm	Sand, %			Silt, % <0.075 to 0.005 mm	Clay, % <0.005 mm	Colloids, % < 0.001 mm
	Coarse <4.75 to 2.0 mm	Medium <2.0 to 0.425 mm	Fine <0.425 to 0.075 mm			
9.3	3.4	1.9	23.0	43.3	19.1	NT*

NT* Sample not tested for colloids

August 22, 2014

REVIEWED BY: Jason Thompson, CET



LABORATORY
 199 Henlow Bay
 Winnipeg MB R3Y 1G4
 Tel: (204) 488-6999

**PARTICLE SIZE ANALYSIS
 ASTM D422**

JR Cousin Consultants Ltd.
 91A Scurfield Blvd.
 Winnipeg, Manitoba
 R3Y 1G4

PROJECT: Dauphin Waste Disposal
 Ground Upgrade/Expansion

Attention: Oswald Wohlgemut

PROJECT NO.: 123311458

SAMPLED BY: Client
 SAMPLE ID: TH3 @ 0.0 - 0.2 m

DATE RECEIVED: August 19, 2014
 TESTED BY: Sothea Bun

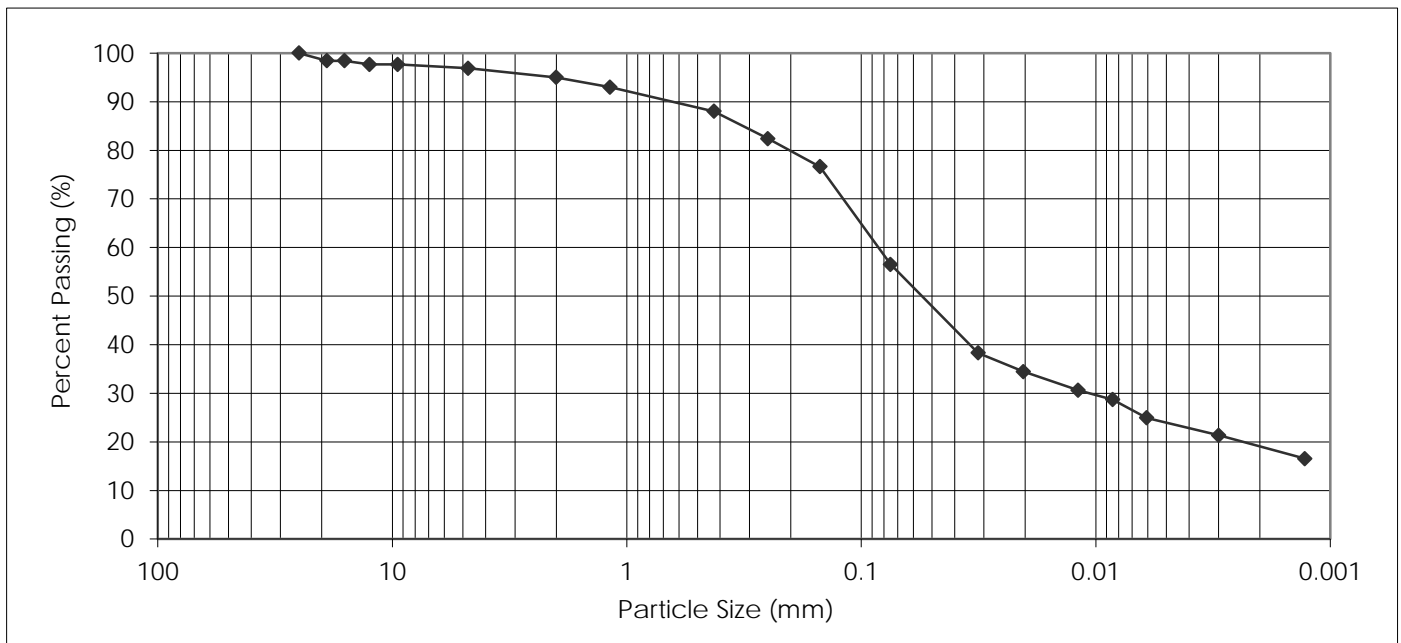

PARTICLE SIZE	PERCENT PASSING	PARTICLE SIZE	PERCENT PASSING
37.50 mm	100.0	1.18 mm	93.0
25.00 mm	100.0	0.425 mm	88.0
19.00 mm	98.4	0.250 mm	82.4
16.00 mm	98.4	0.150 mm	76.6
12.50 mm	97.7	0.075 mm	56.5
9.50 mm	97.7	0.005 mm	23.7
4.75 mm	96.9	0.002 mm	18.6
2.00 mm	95.0	0.001 mm	NT*

Gravel, % 75 to 4.75 mm	Sand, %			Silt, % <0.075 to 0.005 mm	Clay, % <0.005 mm	Colloids, % < 0.001 mm
	Coarse <4.75 to 2.0 mm	Medium <2.0 to 0.425 mm	Fine <0.425 to 0.075 mm			
3.1	1.9	7.0	31.5	32.8	23.7	NT*

NT* Sample not tested for colloids

August 22, 2014

REVIEWED BY:  Jason Thompson, CET



LABORATORY
 199 Henlow Bay
 Winnipeg MB R3Y 1G4
 Tel: (204) 488-6999

**PARTICLE SIZE ANALYSIS
 ASTM D422**

JR Cousin Consultants Ltd.
 91A Scurfield Blvd.
 Winnipeg, Manitoba
 R3Y 1G4

PROJECT: Dauphin Waste Disposal
 Ground Upgrade/Expansion

Attention: Oswald Wohlgemut

PROJECT NO.: 123311458

SAMPLED BY: Client
 SAMPLE ID: TH3 @ 0.3 - 1.0 m

DATE RECEIVED: August 19, 2014
 TESTED BY: Sothea Bun

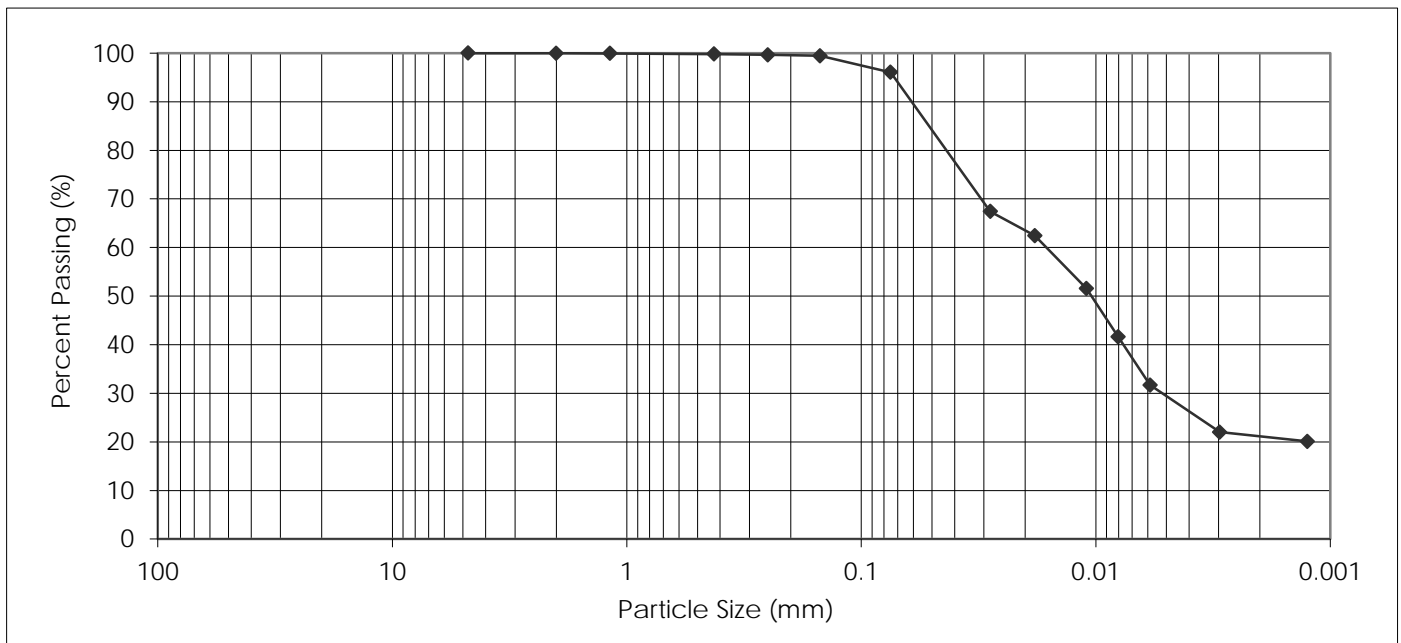

PARTICLE SIZE	PERCENT PASSING
37.50 mm	100.0
25.00 mm	100.0
19.00 mm	100.0
16.00 mm	100.0
12.50 mm	100.0
9.50 mm	100.0
4.75 mm	100.0
2.00 mm	100.0

PARTICLE SIZE	PERCENT PASSING
1.18 mm	99.9
0.425 mm	99.8
0.250 mm	99.7
0.150 mm	99.4
0.075 mm	96.0
0.005 mm	28.8
0.002 mm	20.9
0.001 mm	NT*

Gravel, % 75 to 4.75 mm	Sand, %			Silt, % <0.075 to 0.005 mm	Clay, % <0.005 mm	Colloids, % < 0.001 mm
	Coarse <4.75 to 2.0 mm	Medium <2.0 to 0.425 mm	Fine <0.425 to 0.075 mm			
0.0	0.0	0.2	3.8	67.2	28.8	NT*

NT* Sample not tested for colloids

August 22, 2014

REVIEWED BY:  Jason Thompson, CET



LABORATORY
 199 Henlow Bay
 Winnipeg MB R3Y 1G4
 Tel: (204) 488-6999

**PARTICLE SIZE ANALYSIS
 ASTM D422**

JR Cousin Consultants Ltd.
 91A Scurfield Blvd.
 Winnipeg, Manitoba
 R3Y 1G4

PROJECT: Dauphin Waste Disposal
 Ground Upgrade/Expansion

Attention: Oswald Wohlgemut

PROJECT NO.: 123311458

SAMPLED BY: Client
 SAMPLE ID: TH4 @ 2.0 - 3.0 m

DATE RECEIVED: August 19, 2014
 TESTED BY: Sothea Bun

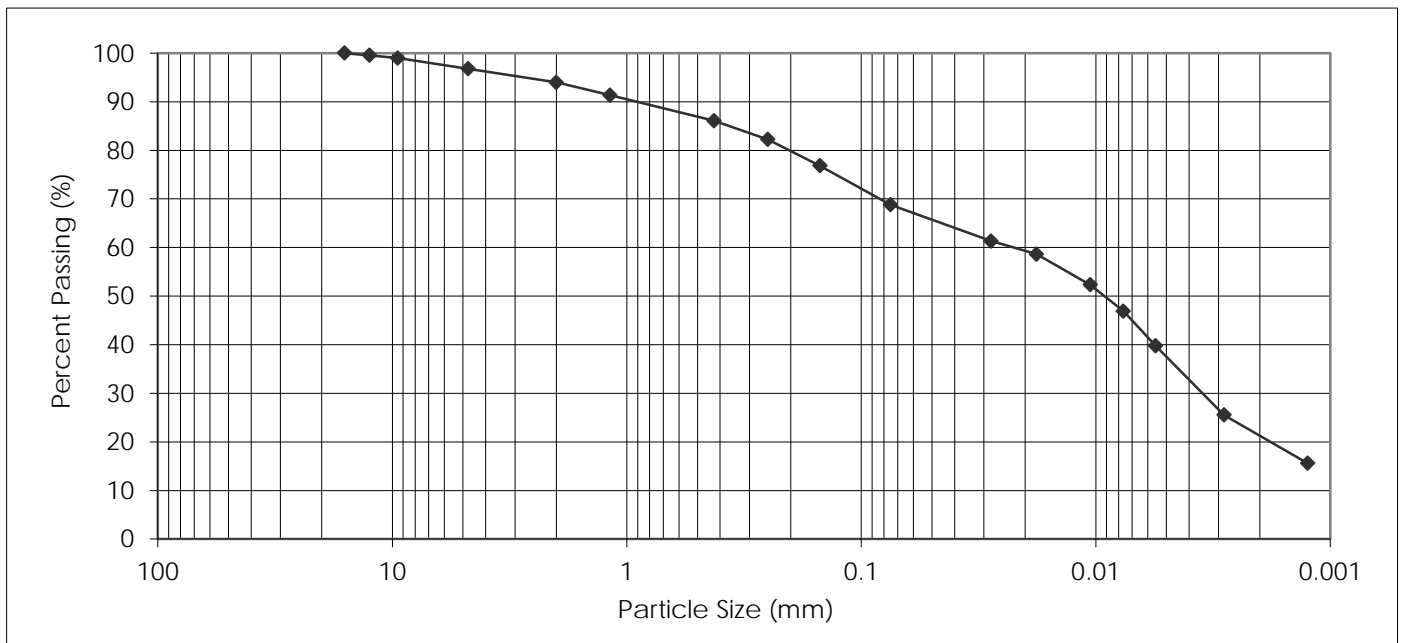

PARTICLE SIZE	PERCENT PASSING	PARTICLE SIZE	PERCENT PASSING
37.50 mm	100.0	1.18 mm	91.3
25.00 mm	100.0	0.425 mm	86.1
19.00 mm	100.0	0.250 mm	82.2
16.00 mm	100.0	0.150 mm	76.8
12.50 mm	99.6	0.075 mm	68.8
9.50 mm	99.0	0.005 mm	36.8
4.75 mm	96.8	0.002 mm	20.3
2.00 mm	94.0	0.001 mm	NT*

Gravel, % 75 to 4.75 mm	Sand, %			Silt, % <0.075 to 0.005 mm	Clay, % <0.005 mm	Colloids, % < 0.001 mm
	Coarse <4.75 to 2.0 mm	Medium <2.0 to 0.425 mm	Fine <0.425 to 0.075 mm			
3.2	2.8	7.9	17.3	32.0	36.8	NT*

NT* Sample not tested for colloids

August 22, 2014

REVIEWED BY:  Jason Thompson, CET



LABORATORY
 199 Henlow Bay
 Winnipeg MB R3Y 1G4
 Tel: (204) 488-6999

**PARTICLE SIZE ANALYSIS
 ASTM D422**

JR Cousin Consultants Ltd.
 91A Scurfield Blvd.
 Winnipeg, Manitoba
 R3Y 1G4

PROJECT: Dauphin Waste Disposal
 Ground Upgrade/Expansion

Attention: Oswald Wohlgemut

PROJECT NO.: 123311458

SAMPLED BY: Client
 SAMPLE ID: TH7 @ 1.2 - 2.4 m

DATE RECEIVED: August 19, 2014
 TESTED BY: Sothea Bun

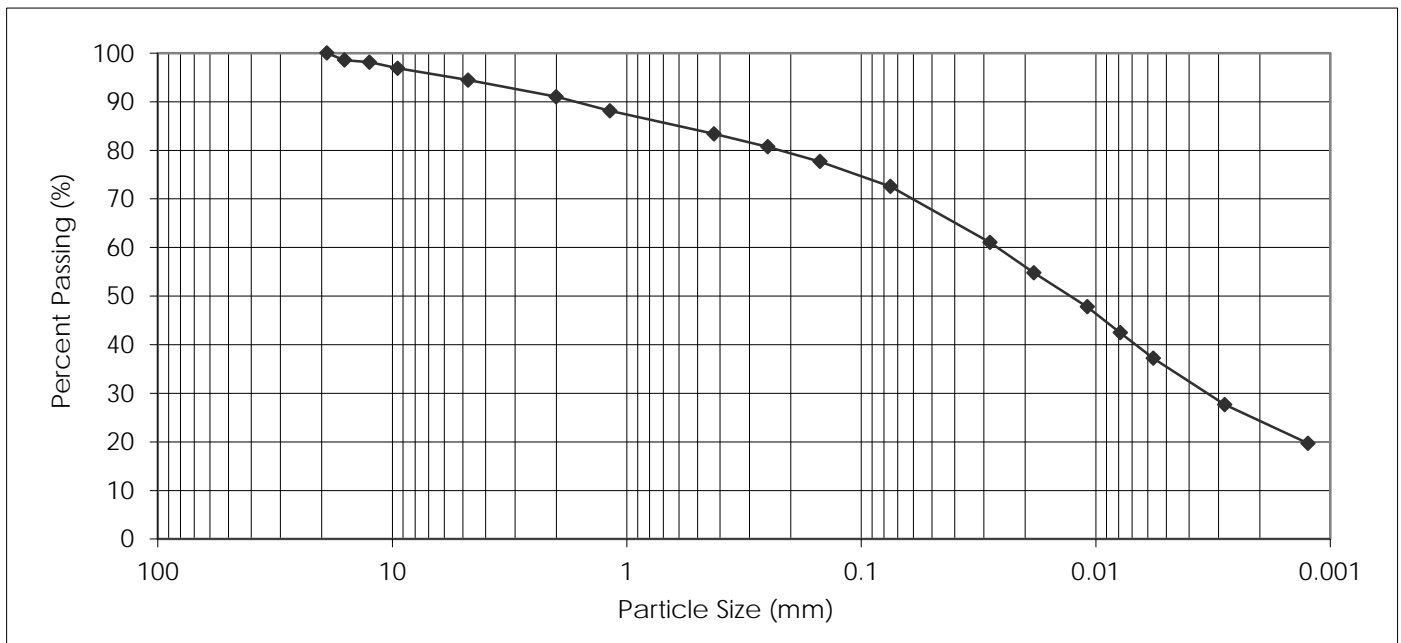

PARTICLE SIZE	PERCENT PASSING	PARTICLE SIZE	PERCENT PASSING
37.50 mm	100.0	1.18 mm	88.1
25.00 mm	100.0	0.425 mm	83.4
19.00 mm	100.0	0.250 mm	80.7
16.00 mm	98.6	0.150 mm	77.7
12.50 mm	98.2	0.075 mm	72.5
9.50 mm	96.9	0.005 mm	35.0
4.75 mm	94.5	0.002 mm	23.5
2.00 mm	91.0	0.001 mm	NT*

Gravel, % 75 to 4.75 mm	Sand, %			Silt, % <0.075 to 0.005 mm	Clay, % <0.005 mm	Colloids, % < 0.001 mm
	Coarse <4.75 to 2.0 mm	Medium <2.0 to 0.425 mm	Fine <0.425 to 0.075 mm			
5.5	3.5	7.6	10.9	37.5	35.0	NT*

NT* Sample not tested for colloids

August 22, 2014

REVIEWED BY:  Jason Thompson, CET



LABORATORY
 199 Henlow Bay
 Winnipeg MB R3Y 1G4
 Tel: (204) 488-6999

PARTICLE SIZE ANALYSIS
ASTM D422

JR Cousin Consultants Ltd.
 91A Scurfield Blvd.
 Winnipeg, Manitoba
 R3Y 1G4

PROJECT: Dauphin Waste Disposal
 Ground Upgrade/Expansion

Attention: Oswald Wohlgemut

PROJECT NO.: 123311458

SAMPLED BY: Client
 SAMPLE ID: TH7 @ 3.5 - 5.0 m

DATE RECEIVED: August 19, 2014
 TESTED BY: Sothea Bun

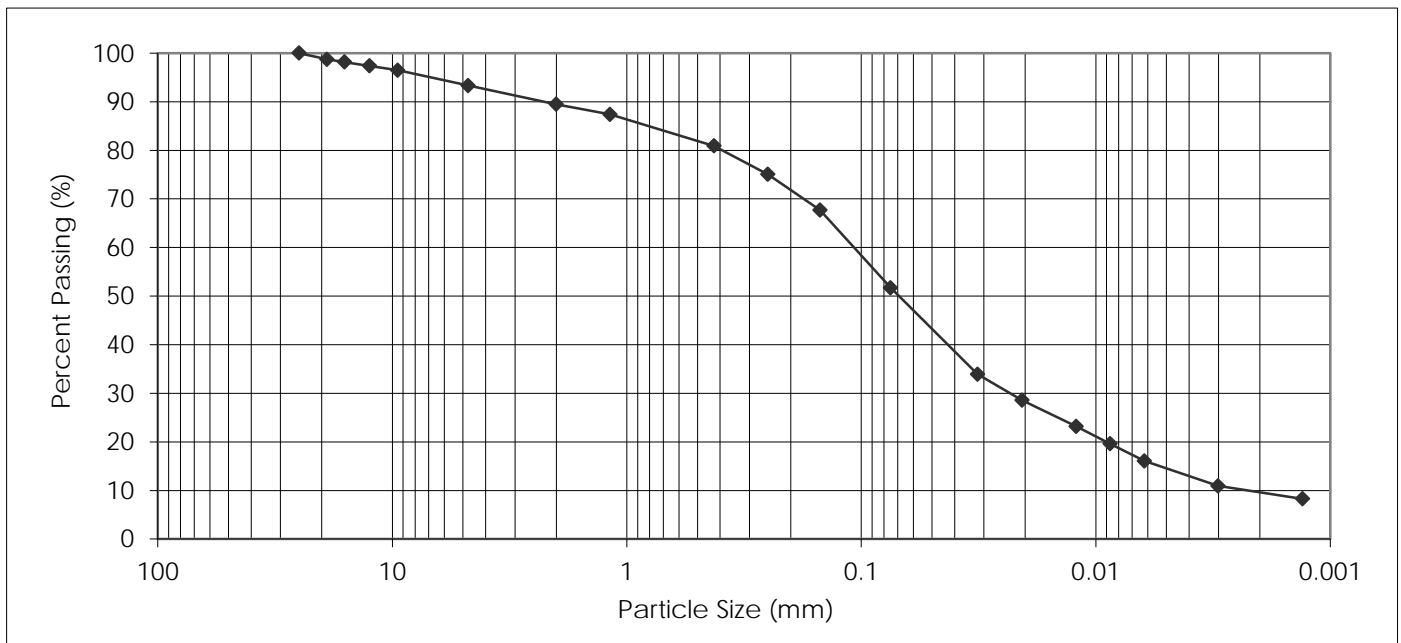

PARTICLE SIZE	PERCENT PASSING
37.50 mm	100.0
25.00 mm	100.0
19.00 mm	98.7
16.00 mm	98.2
12.50 mm	97.4
9.50 mm	96.5
4.75 mm	93.3
2.00 mm	89.5

PARTICLE SIZE	PERCENT PASSING
1.18 mm	87.4
0.425 mm	80.9
0.250 mm	75.0
0.150 mm	67.7
0.075 mm	51.7
0.005 mm	14.1
0.002 mm	9.4
0.001 mm	NT*

Gravel, % 75 to 4.75 mm	Sand, %			Silt, % <0.075 to 0.005 mm	Clay, % <0.005 mm	Colloids, % < 0.001 mm
	Coarse <4.75 to 2.0 mm	Medium <2.0 to 0.425 mm	Fine <0.425 to 0.075 mm			
6.7	3.8	8.6	29.2	37.6	14.1	NT*

NT* Sample not tested for colloids

August 22, 2014

REVIEWED BY:  Jason Thompson, CET



LABORATORY
 199 Henlow Bay
 Winnipeg MB R3Y 1G4
 Tel: (204) 488-6999

PARTICLE SIZE ANALYSIS
ASTM D422

JR Cousin Consultants Ltd.
 91A Scurfield Blvd.
 Winnipeg, Manitoba
 R3Y 1G4

PROJECT: Dauphin Waste Disposal
 Ground Upgrade/Expansion

Attention: Oswald Wohlgemut

PROJECT NO.: 123311458

SAMPLED BY: Client
 SAMPLE ID: TH8 @ 0.3 - 1.4 m

DATE RECEIVED: August 19, 2014
 TESTED BY: Sothea Bun

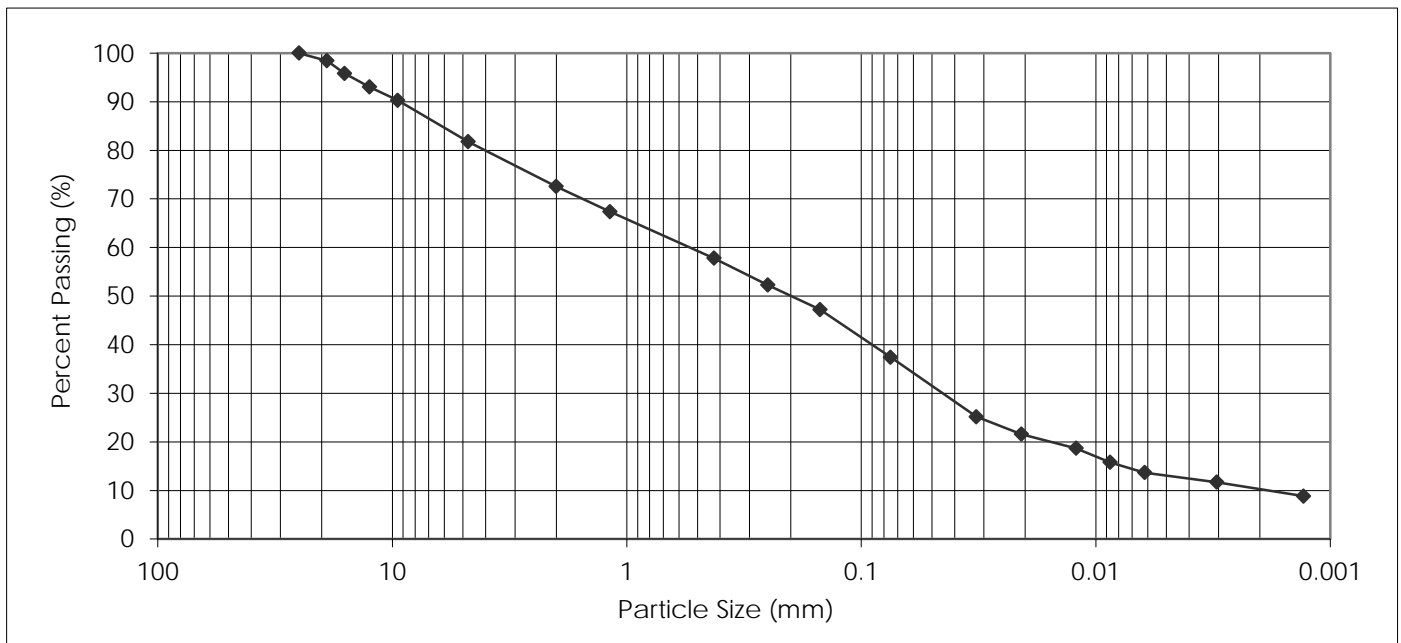

PARTICLE SIZE	PERCENT PASSING
37.50 mm	100.0
25.00 mm	100.0
19.00 mm	98.4
16.00 mm	95.8
12.50 mm	93.0
9.50 mm	90.3
4.75 mm	81.8
2.00 mm	72.6

PARTICLE SIZE	PERCENT PASSING
1.18 mm	67.4
0.425 mm	57.8
0.250 mm	52.3
0.150 mm	47.2
0.075 mm	37.4
0.005 mm	12.9
0.002 mm	10.0
0.001 mm	NT*

Gravel, % 75 to 4.75 mm	Sand, %			Silt, % <0.075 to 0.005 mm	Clay, % <0.005 mm	Colloids, % < 0.001 mm
	Coarse <4.75 to 2.0 mm	Medium <2.0 to 0.425 mm	Fine <0.425 to 0.075 mm			
18.2	9.2	14.8	20.4	24.5	12.9	NT*

NT* Sample not tested for colloids

August 22, 2014

REVIEWED BY:  Jason Thompson, CET



Atterberg Limits
 ASTM D4318
 Method B- One Point

Client: JR Cousin Consultants Ltd.
 Project Name: Dauphin Waste Disposal Ground Upgrade/Expansion
 Project No: 123311458
 Date Received: August 19, 2014
 Date Tested: August 21, 2014
 Tested By: Larry Presado

LABORATORY
 199 Henlow Bay
 Winnipeg, Manitoba
 Canada R3Y 1G4
 Tel: (204) 488-6999

Sample:		Sample:	
TH2 @ 2.9 - 3.8m		TH2 @ 1.2 - 2.9m	
LIQUID		LIQUID	
1	2	Trial No.	
22	23	Number of Blows	23 23
418	445	Container Number	478 603
43.92	51.86	Wt. Sample (wet+tare)(g)	47.49 51.17
39.55	47.24	Wt. Sample (dry+tare)(g)	43.41 46.59
20.23	26.68	Wt. Tare (g)	26.08 26.84
19.3	20.6	Wt. Dry Soil (g)	17.3 19.8
4.4	4.6	Wt. Water (g)	4.1 4.6
22.6%	22.5%	Water Content (%)	23.5% 23.2%
22.3%	22.2%	Corrected Water Content (%)	23.3% 23.0%
PLASTIC		PLASTIC	
1	2	Trial No.	
429	528	Container Number	407 517
34.42	37.31	Wt. Sample (wet+tare)(g)	34.24 42.49
33.2	35.79	Wt. Sample (dry+tare)(g)	32.57 41.1
24.07	24.37	Wt. Tare (g)	19.3 29.92
9.1	11.4	Wt. Dry Soil (g)	13.3 11.2
1.2	1.5	Wt. Water (g)	1.7 1.4
13.4%	13.3%	Water Content (%)	12.6% 12.4%
AVERAGE VALUES		AVERAGE VALUES	
1	2	1	2
LL	23	LL	23
PL	13	PL	13
PI	9	PI	11
CLASSIFICATION		CLASSIFICATION	
CL		CL	

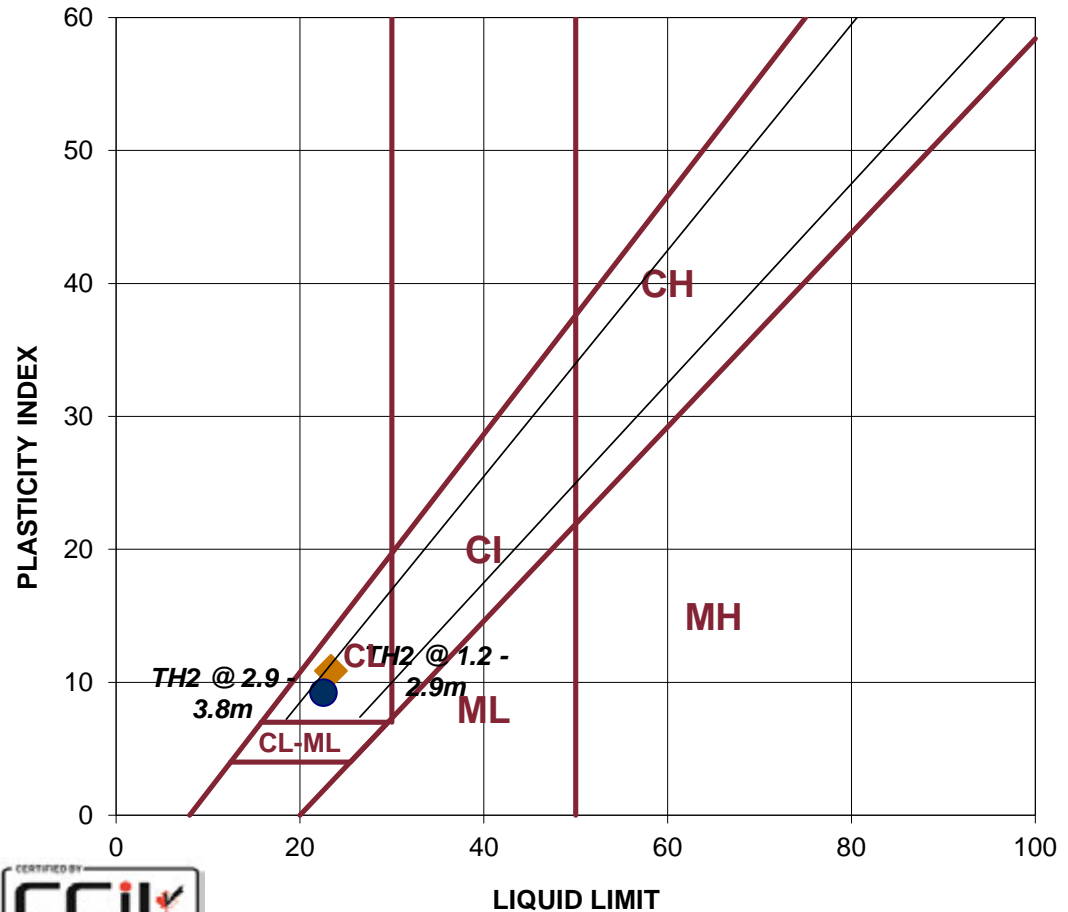

Reporting of these test results constitutes a testing service only. Engineering interpretation or evaluation of the test results is provided only on written request. The data presented above is for the sole use of the client stipulated above. STANTEC is not responsible, nor can be held liable, for the use of this report by any other party, with or without the knowledge of STANTEC.

Reviewed By: Jason Thompson, CET



Atterberg Limits
 ASTM D4318
 Method B- One Point

Client: JR Cousin Consultants Ltd.
 Project Name: Dauphin Waste Disposal Ground Upgrade/Expansion
 Project No: 123311458
 Date Received: August 19, 2014
 Date Tested: August 21, 2014
 Tested By: Larry Presado

LABORATORY
 199 Henlow Bay
 Winnipeg, Manitoba
 Canada R3Y 1G4

Tel: (204) 488-6999

Sample: TH3 @ 0- 0.2 m		Sample: TH3 @ 0.3 -1.0m	
LIQUID		LIQUID	
1	2	Trial No.	
23	24	Number of Blows	28 27
504	414	Container Number	422 501
42.96	36.32	Wt. Sample (wet+tare)(g)	52.90 54.88
36.62	30.07	Wt. Sample (dry+tare)(g)	48.29 49.56
22.80	16.38	Wt. Tare (g)	30.76 29.30
13.8	13.7	Wt. Dry Soil (g)	17.5 20.3
6.3	6.3	Wt. Water (g)	4.6 5.3
45.9%	45.7%	Water Content (%)	26.3% 26.3%
45.4%	45.4%	Corrected Water Content (%)	26.7% 26.5%
PLASTIC		PLASTIC	
1	2	Trial No.	
473	531	Container Number	428 498
39.67	38.55	Wt. Sample (wet+tare)(g)	36.67 40.88
36.26	34.79	Wt. Sample (dry+tare)(g)	35.19 39.24
24.32	22.09	Wt. Tare (g)	24.94 28.22
11.9	12.7	Wt. Dry Soil (g)	10.3 11.0
3.4	3.8	Wt. Water (g)	1.5 1.6
28.6%	29.6%	Water Content (%)	14.4% 14.9%
AVERAGE VALUES		AVERAGE VALUES	
1	2	1	2
LL	46	LL	26
PL	29	PL	15
PI	17	PI	12
CLASSIFICATION		CLASSIFICATION	
ML		CL	

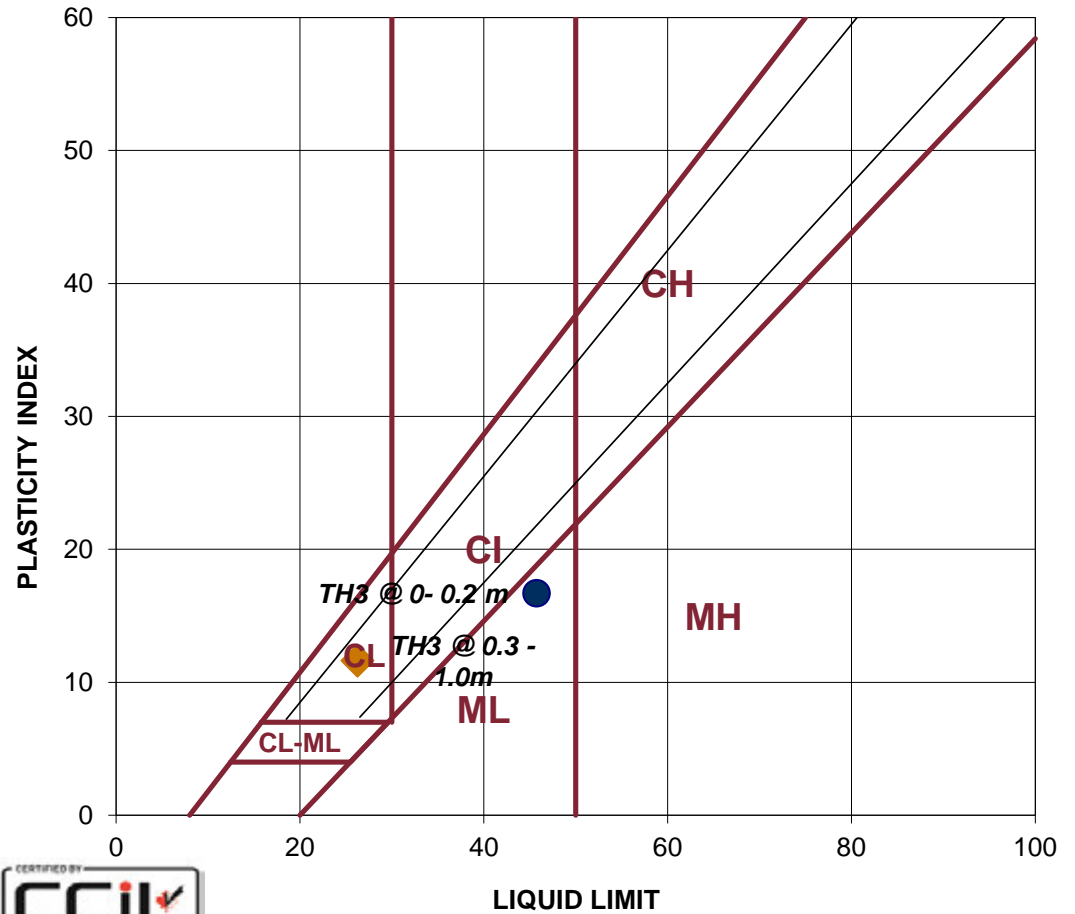

Reporting of these test results constitutes a testing service only. Engineering interpretation or evaluation of the test results is provided only on written request. The data presented above is for the sole use of the client stipulated above. STANTEC is not responsible, nor can be held liable, for the use of this report by any other party, with or without the knowledge of STANTEC.

Reviewed By: Jason Thompson, CET



Atterberg Limits
 ASTM D4318
 Method B- One Point

Client: JR Cousin Consultants Ltd.
 Project Name: Dauphin Waste Disposal Ground Upgrade/Expansion
 Project No: 123311458
 Date Received: August 19, 2014
 Date Tested: August 21, 2014
 Tested By: Larry Presado

LABORATORY
 199 Henlow Bay
 Winnipeg, Manitoba
 Canada R3Y 1G4
 Tel: (204) 488-6999

Sample: TH7 @ 1.2 - 2.4m		Sample: TH7@ 3.1 -5.0m	
LIQUID		LIQUID	
1	2	Trial No.	
24	25	Number of Blows	26 28
416	433	Container Number	512 417
45.28	42.06	Wt. Sample (wet+tare)(g)	50.76 47.98
40.63	38.31	Wt. Sample (dry+tare)(g)	47.72 44.17
20.53	21.99	Wt. Tare (g)	28.27 19.76
20.1	16.3	Wt. Dry Soil (g)	19.5 24.4
4.7	3.8	Wt. Water (g)	3.0 3.8
23.1%	23.0%	Water Content (%)	15.6% 15.6%
23.0%	23.0%	Corrected Water Content (%)	15.7% 15.8%
PLASTIC		PLASTIC	
1	2	Trial No.	
534	475	Container Number	605 425
42.33	50.41	Wt. Sample (wet+tare)(g)	40.63 47.38
40.77	48.46	Wt. Sample (dry+tare)(g)	38.86 45.11
25.33	30.37	Wt. Tare (g)	24.61 26.74
15.4	18.1	Wt. Dry Soil (g)	14.3 18.4
1.6	2.0	Wt. Water (g)	1.8 2.3
10.1%	10.8%	Water Content (%)	12.4% 12.4%
AVERAGE VALUES		AVERAGE VALUES	
1	2	1	2
LL	23	LL	16
PL	10	PL	12
PI	13	PI	3
CLASSIFICATION		CLASSIFICATION	
CL		ML	

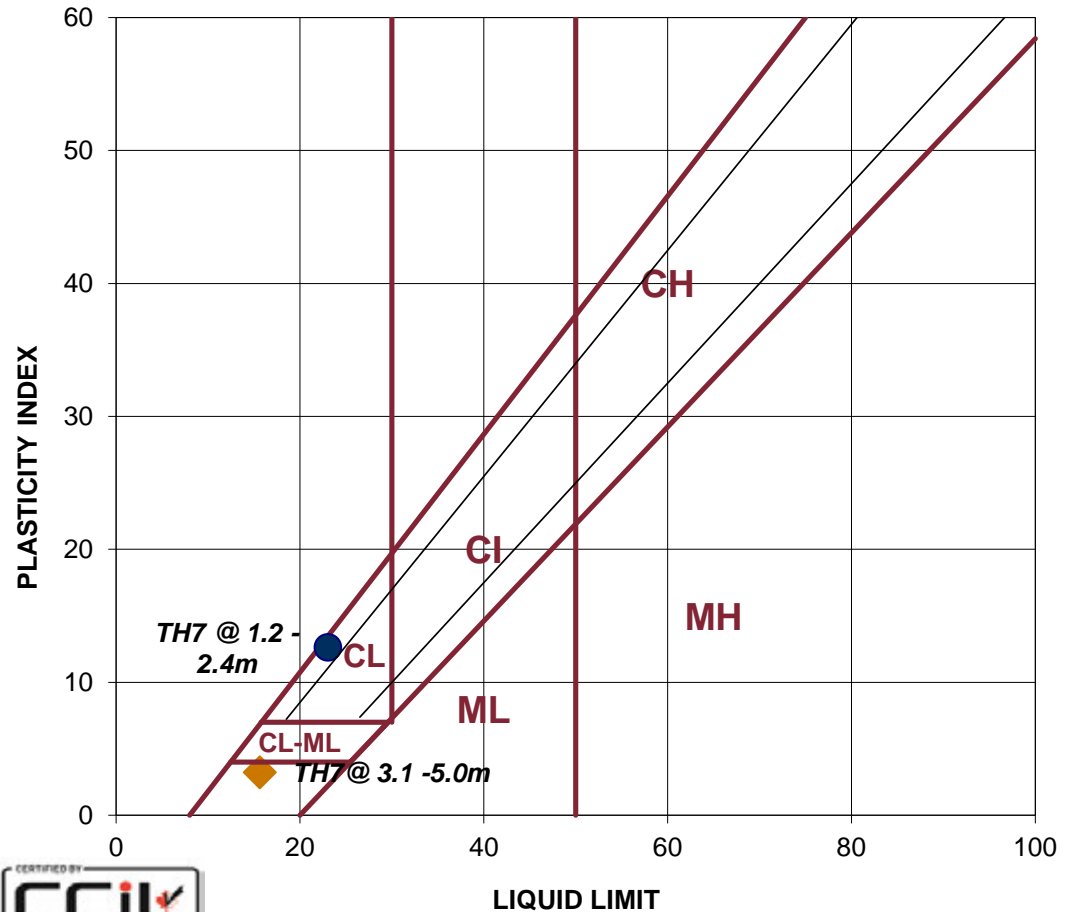

Reporting of these test results constitutes a testing service only. Engineering interpretation or evaluation of the test results is provided only on written request. The data presented above is for the sole use of the client stipulated above. STANTEC is not responsible, nor can be held liable, for the use of this report by any other party, with or without the knowledge of STANTEC.

Reviewed By: Jason Thompson, CET



Atterberg Limits
 ASTM D4318
 Method B- One Point

Client: JR Cousin Consultants Ltd.
 Project Name: Dauphin Waste Disposal Ground Upgrade/Expansion
 Project No: 123311458
 Date Received: August 19, 2014
 Date Tested: August 21, 2014
 Tested By: Larry Presado

LABORATORY
 199 Henlow Bay
 Winnipeg, Manitoba
 Canada R3Y 1G4
 Tel: (204) 488-6999

Sample:		Sample:	
TH4 @ 2.0 - 3.0 m		TH8 @ 0.3 -1.4m	
LIQUID		LIQUID	
1	2	Trial No.	
22	23	Number of Blows	22 23
409	526	Container Number	533 525
51.62	44.38	Wt. Sample (wet+tare)(g)	45.15 51.62
48.06	40.80	Wt. Sample (dry+tare)(g)	41.29 46.92
30.08	22.87	Wt. Tare (g)	22.95 24.62
18.0	17.9	Wt. Dry Soil (g)	18.3 22.3
3.6	3.6	Wt. Water (g)	3.9 4.7
19.8%	20.0%	Water Content (%)	21.0% 21.1%
19.5%	19.8%	Corrected Water Content (%)	20.7% 20.9%
PLASTIC		PLASTIC	
1	2	Trial No.	
516	476	Container Number	484 513
34.95	38.46	Wt. Sample (wet+tare)(g)	43.58 41.78
33.69	37.07	Wt. Sample (dry+tare)(g)	41.29 39.62
23.58	25.79	Wt. Tare (g)	26.86 25.79
10.1	11.3	Wt. Dry Soil (g)	14.4 13.8
1.3	1.4	Wt. Water (g)	2.3 2.2
12.5%	12.3%	Water Content (%)	15.9% 15.6%
AVERAGE VALUES		AVERAGE VALUES	
1	2	1	2
LL	20	LL	21
PL	12	PL	16
PI	7	PI	5
CLASSIFICATION		CLASSIFICATION	
CL		CL-ML	

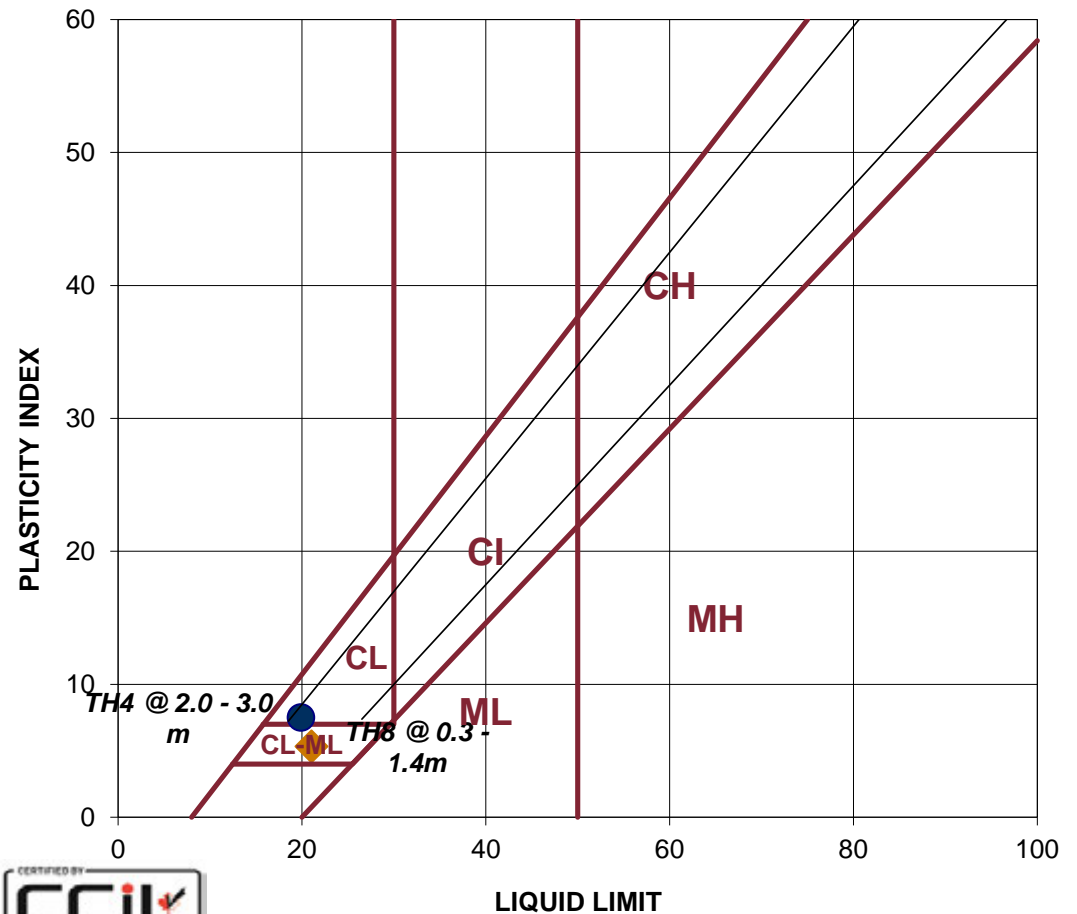

Reporting of these test results constitutes a testing service only. Engineering interpretation or evaluation of the test results is provided only on written request. The data presented above is for the sole use of the client stipulated above. STANTEC is not responsible, nor can be held liable, for the use of this report by any other party, with or without the knowledge of STANTEC.

Reviewed By: Jason Thompson, CET

Stantec Consulting Ltd. Soils Analysis Report, October 6, 2014



October 6, 2014
File: 123311505

Attention: Oswald Wohlgemut

J.R. Cousin Consultants Ltd.
91A Scurfield Blvd.
Winnipeg, MB R3Y 1G4

Dear Oswald,

Reference: Dauphin Waste Disposal Ground Upgrade/ Expansion

Soil samples were submitted to our laboratory on September 5, 2014. The following tests were conducted on the soil sample:

- Moisture-density relationship (Proctor) of cohesive soils (ASTM D698)
- hydraulic conductivity (ASTM D5084)

The test results for the soil samples are summarized in the following table and in the attached moisture-density relationship and hydraulic conductivity reports.

Testhole ID	Testhole Depth (m)	Optimum Moisture Content (%)	Hydraulic Conductivity, "k ₂₀ "
TH2	1.2-2.9	13.5	1.3 x 10 ⁻⁸ cm/s
TH7	1.2-2.4	11.5	2.8 x 10 ⁻⁸ cm/s

Note: Note: Sample was compacted into 70 mm mold using the compactive effort outlined in standard test method ASTM D698, Method C prior to testing

An assessment of the soil samples was conducted to determine whether the soil could be used in-situ as a waste disposal ground liner and would obtain a hydraulic conductivity of less than 1.0 x 10⁻⁷ cm/sec when re-moulded and re-compacted.

The sample TH2 at 1.2-2.9 m and sample TH7 at 1.2-2.4 m were re-worked and re-compacted to 96% of the Standard Proctor Density. The hydraulic conductivity results for the re-compacted samples were less than the specified maximum hydraulic conductivity value of 1.0 x 10⁻⁷ cm/s for Waste Disposal Ground.

Based on the test result the soil samples for TH2 and TH7 noted above are considered suitable to be used as a Waste Disposal Ground liner when re-moulded and re-compacted.



October 6, 2014
Page 2 of 2

Reference: Reference

We appreciate the opportunity to assist you in this project. Please call if you have any questions regarding this report.

Regards,

STANTEC CONSULTING LTD.

Jason Thompson, C.E.T.
Associate - Manager, Materials Testing Services
Phone: (204) 928-4004
Fax: (204) 488-6947
Jason.Thompson@stantec.com

Attachment: 2x – Moisture-density relationship (Proctor) Test Report
2x – Hydraulic Conductivity Test Report

PROCTOR TEST REPORT

TO J.R. Cousin Consultants Ltd.
91A Scurfield Blvd.
Winnipeg, MB
R3Y 1G4

CLIENT J.R. Cousin Consultants Ltd.
C.C.

ATTN: Oswald Wohlgenut

PROJECT Dauphin Waste Disposal Grounds

Dauphin

PROJECT NO. 123311505

PROCTOR NO. 1

DATE SAMPLED 2014.Sep.04

DATE RECEIVED 2014.Sep.05

DATE TESTED 2014.Sep.10

INSITU MOISTURE	N/A %	COMPACTION STANDARD	Standard Proctor, ASTM D698
TESTED BY	Donald Eliazar	COMPACTION PROCEDURE	A: 101.6mm Mold, Passing 4.75mm
MATERIAL IDENTIFICATION		RAMMER TYPE	Manual
MATERIAL USE	Subgrade	PREPARATION	Moist
MAX. NOMINAL SIZE	Clay	OVERSIZE CORRECTION METHOD	None
MATERIAL TYPE	Clay	RETAINED 4.75mm SCREEN	
SUPPLIER	Not provided		
SOURCE	Not provided		

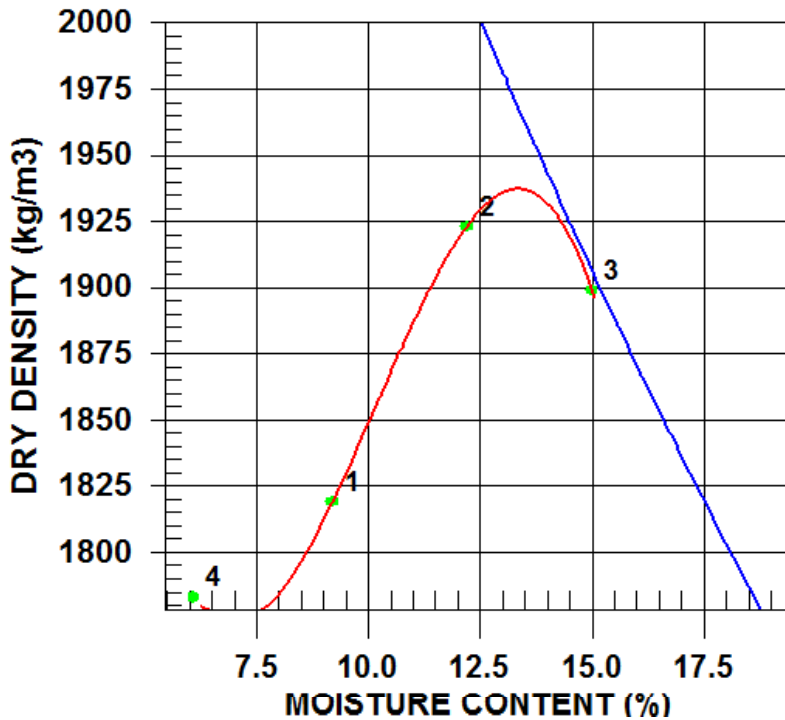

TRIAL NUMBER	WET DENSITY (kg/m ³)	DRY DENSITY (kg/m ³)	MOISTURE CONTENT (%)
1	1986	1819	9.2
2	2158	1923	12.2
3	2184	1899	15.0
4	1892	1783	6.1

	MAXIMUM DRY DENSITY (kg/m ³)	OPTIMUM MOISTURE CONTENT (%)
CALCULATED	1940	13.5
OVERSIZE CORRECTED		

COMMENTS

Sample obtained and submitted by client.

PROCTOR TEST REPORT

TO J.R. Cousin Consultants Ltd.
91A Scurfield Blvd.
Winnipeg, MB
R3Y 1G4

CLIENT J.R. Cousin Consultants Ltd.
C.C.

ATTN: Oswald Wohlgenut

PROJECT Dauphin Waste Disposal Grounds

Dauphin

PROJECT NO. 123311505

PROCTOR NO. 2

DATE SAMPLED 2014.Sep.04

DATE RECEIVED 2014.Sep.05

DATE TESTED 2014.Sep.10

INSITU MOISTURE	N/A %	COMPACTION STANDARD	Standard Proctor, ASTM D698
TESTED BY	Donald Eliazar	COMPACTION PROCEDURE	A: 101.6mm Mold, Passing 4.75mm
MATERIAL IDENTIFICATION		RAMMER TYPE	Manual
MATERIAL USE	Subgrade	PREPARATION	Moist
MAX. NOMINAL SIZE	Clay	OVERSIZE CORRECTION METHOD	ASTM 4718
MATERIAL TYPE	Clay	RETAINED 4.75mm SCREEN	5.2 %
SUPPLIER	Not provided		
SOURCE	Not provided		

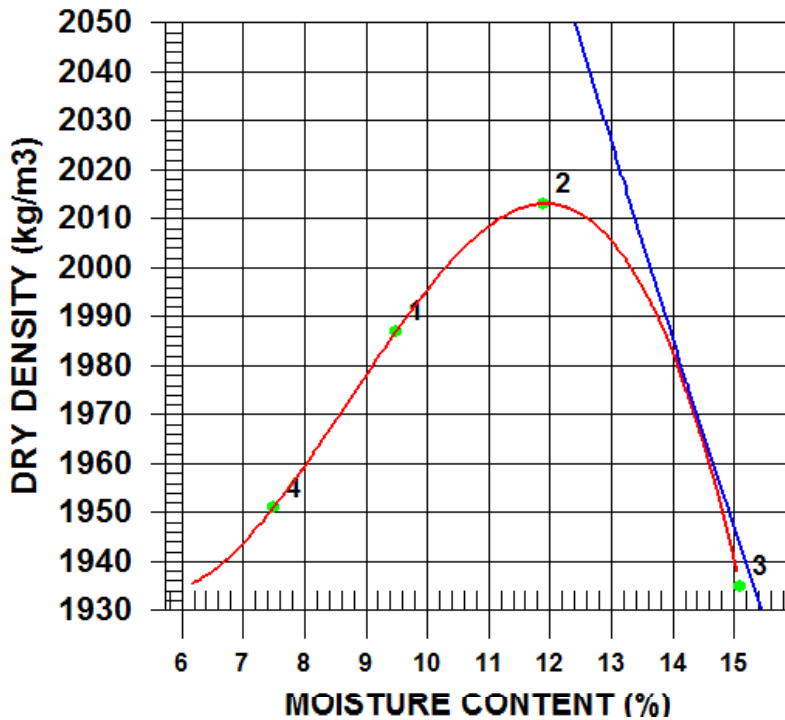

TRIAL NUMBER	WET DENSITY (kg/m ³)	DRY DENSITY (kg/m ³)	MOISTURE CONTENT (%)
1	2176	1987	9.5
2	2253	2013	11.9
3	2227	1935	15.1
4	2097	1951	7.5

	MAXIMUM DRY DENSITY (kg/m ³)	OPTIMUM MOISTURE CONTENT (%)
CALCULATED	2010	12.0
OVERSIZE CORRECTED	2040	11.5

COMMENTS

Sample obtained and submitted by client. Maximum dry density corrected for oversize materials (ASTM D4718).



LABORATORY
 199 Henlow Bay
 Winnipeg MB R3Y 1G4
 Tel: (204) 488-6999

**HYDRAULIC CONDUCTIVITY
 ASTM D5084**

J.R. Cousin Consultants Ltd.
 91A Scurfield Blvd.
 Winnipeg, MB
 R3Y 1G4

PROJECT: Dauphin Waste
 Disposal Ground
 Upgrade/Expansion

Attention: Oswald Wohlgemut

PROJECT NO.: 123311505

SAMPLE I.D.: TH2 at 1.2-2.9 m
SOIL DESCRIPTION: Brown, firm, moist, high plasticity clay
 trace Silt
DATE TESTED: September 13 to September 26, 2014
CONFINING PRESSURE (kPa): 137.9
EFFECTIVE SATURATION STRESS (kPa): 34.5
ASSUMED SPECIFIC GRAVITY: 2.71
HYDRAULIC GRADIENT: 19.2
TYPE OF PERMEANT LIQUID: De-aired Water
HYDRAULIC CONDUCTIVITY, "k" (cm/s): 1.4E-08
HYDRAULIC CONDUCTIVITY, "k₂₀" (cm/s): 1.3E-08

	Height (mm)	Diameter (mm)	Wet Mass (g)	Dry Density (g/cm ³)	Water Content (%)	Saturation (%)
Initial Reading	78.4	71.3	690.4	1.939	13.7	93.4
Final Reading	77.4	71.0	693.5	1.994	13.4	101.2

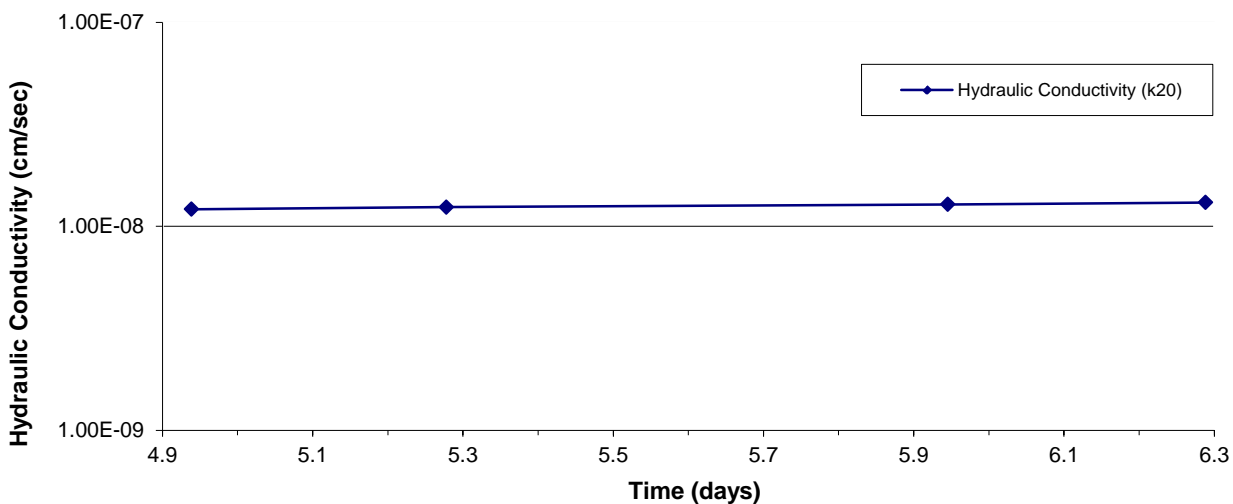

Note: Sample was compacted into 70 mm mold using the compactive effort outlined in standard test method ASTM D698, Method C prior to testing
 October 6, 2014
 REVIEWED BY: Jason Thompson, C.E.T.

Reporting of these test results constitutes a testing service only. Engineering interpretation or evaluation of the test results is provided only on written request. The data presented above is for the sole use of the client stipulated above. Stantec is not responsible, nor can be held liable, for the use of this report by any other party, with or without the knowledge of Stantec.



LABORATORY
 199 Henlow Bay
 Winnipeg MB R3Y 1G4
 Tel: (204) 488-6999

**HYDRAULIC CONDUCTIVITY
 ASTM D5084**

J.R. Cousin Consultants Ltd.
 91A Scurfield Blvd.
 Winnipeg, MB
 R3Y 1G4

**PROJECT: Dauphin Waste
 Disposal Ground
 Upgrade/Expansion**

Attention: Oswald Wohlgemut

PROJECT NO.: 123311505

SAMPLE I.D.: TH7 at 1.2-2.4 m
SOIL DESCRIPTION: Brown, firm, moist, high plasticity clay trace to some silt
DATE TESTED: September 13 to September 20, 2014
CONFINING PRESSURE (kPa): 137.9
EFFECTIVE SATURATION STRESS (kPa): 34.5
ASSUMED SPECIFIC GRAVITY: 2.71
HYDRAULIC GRADIENT: 19.2
TYPE OF PERMEANT LIQUID: De-aired Water
HYDRAULIC CONDUCTIVITY, "k" (cm/s): 3.0E-08
HYDRAULIC CONDUCTIVITY, "k₂₀" (cm/s): 2.8E-08

	Height (mm)	Diameter (mm)	Wet Mass (g)	Dry Density (g/cm ³)	Water Content (%)	Saturation (%)
Initial Reading	77.8	71.6	708.2	2.029	11.5	93.0
Final Reading	77.2	71.0	710.6	2.079	11.8	105.5

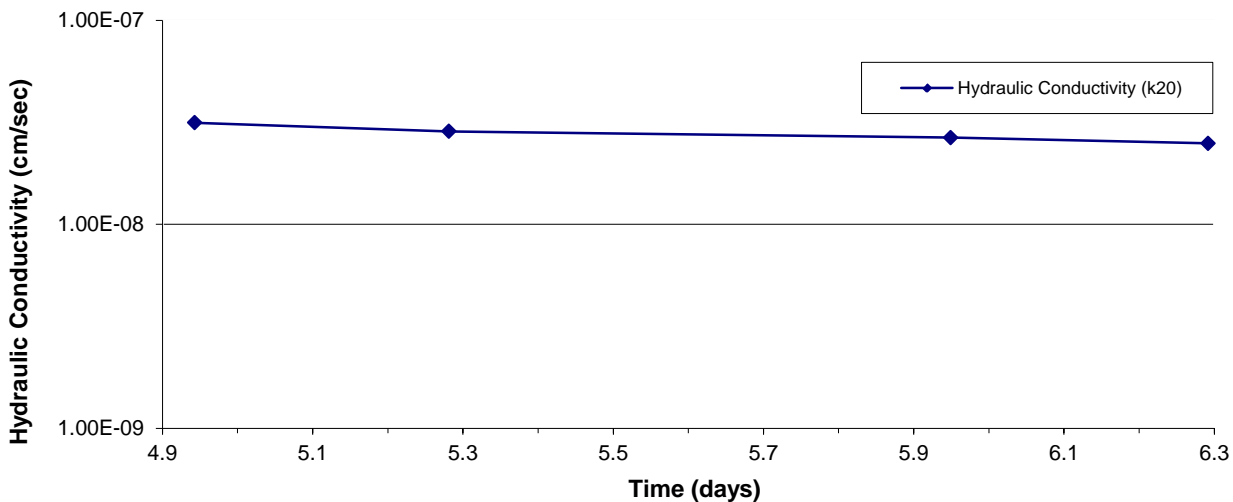

Note: Sample was compacted into 70 mm mold using the compactive effort outlined in standard test method ASTM D698, Method C prior to testing October 6, 2014
 REVIEWED BY: Jason Thompson, C.E.T.

Driller's Well Logs

LOCATION: SW20-25-19W

Well_PID: 51970
Owner: TOWN OF DAUPHIN
Driller: Wescan Drilling Ltd.
Well Name:
Well Use: TEST WELL
Water Use:
UTMX: 422821.146
UTMY: 5669647.82
Accuracy XY: UNKNOWN
UTMZ:
Accuracy Z:
Date Completed: 1984 Jul 01

WELL LOG

From (ft.)	To (ft.)	Log
0	7.0	SAND
7.0	16.0	TILL; BROWN
16.0	17.0	TILL; BLACK
17.0	22.0	SAND; SILTY
22.0	30.0	SHALE; GREY

No construction data for this well.

Top of Casing: ft. below ground

No pump test data for this well.

LOCATION: SW20-25-19W

Well_PID: 51989
Owner: TOWN OF DAUPHIN
Driller: Wescan Drilling Ltd.
Well Name:
Well Use: PRODUCTION
Water Use: Domestic
UTMX: 422821.146
UTMY: 5669647.82
Accuracy XY: UNKNOWN
UTMZ:
Accuracy Z:
Date Completed: 1984 Jul 01

WELL LOG

From (ft.)	To (ft.)	Log
0	6.0	CLAY; SANDY

6.0	7.0	TILL; LIGHT BROWN
7.0	14.0	TILL; BROWN
14.0	19.0	TILL; BLACK
19.0	26.0	SAND; SILTY
26.0	59.0	SHALE; GREY
59.0	64.0	SAND; SALTY WATER
64.0	161.9	SHALE; GREY
161.9	162.9	SAND
162.9	179.9	SHALE; VARIOUS COLOURS, SANDSTONE LAYERS

No construction data for this well.

Top of Casing: ft. below ground

No pump test data for this well.

REMARKS

CL 2800

LOCATION: SW20-25-19W

Well_PID: 51968
 Owner: TOWN OF DAUPHIN
 Driller: Wescan Drilling Ltd.
 Well Name:
 Well Use: TEST WELL
 Water Use:
 UTMX: 422821.146
 UTM Y: 5669647.82
 Accuracy XY: UNKNOWN
 UTM Z:
 Accuracy Z:
 Date Completed: 1984 Jul 01

WELL LOG

From (ft.)	To (ft.)	Log
0	3.0	SAND
3.0	14.0	TILL; BROWN
14.0	15.0	CLAY; SILTY, SOME WATER
15.0	30.0	SHALE; GREY

No construction data for this well.

Top of Casing: ft. below ground

No pump test data for this well.

LOCATION: SW20-25-19W

Well_PID: 51987
Owner: TOWN OF DAUPHIN
Driller: Wescan Drilling Ltd.
Well Name:
Well Use: PRODUCTION
Water Use: Domestic
UTMX: 422821.146
UTMY: 5669647.82
Accuracy XY: UNKNOWN
UTMZ:
Accuracy Z:
Date Completed: 1984 Jul 01

WELL LOG

From (ft.)	To (ft.)	Log
0	12.0	TILL; BROWN
12.0	14.0	GRAVEL

WELL CONSTRUCTION

From (ft.)	To (ft.)	Casing Type	Inside Dia.(in)	Outside Dia.(in)	Slot Size(in)	Type	Material
0	14.0	casing	2.00				PLASTIC
0	0	gravel pack					

Top of Casing: ft. below ground

No pump test data for this well.

LOCATION: SW20-25-19W

Well_PID: 51986
Owner: TOWN OF DAUPHIN
Driller: Wescan Drilling Ltd.
Well Name:
Well Use: PRODUCTION
Water Use: Domestic
UTMX: 422821.146
UTMY: 5669647.82
Accuracy XY: UNKNOWN
UTMZ:
Accuracy Z:
Date Completed: 1984 Jul 01

WELL LOG

From (ft.)	To (ft.)	Log
0	7.0	SAND
7.0	16.0	TILL; BROWN
16.0	19.0	TILL; BLACK
19.0	21.0	SAND

WELL CONSTRUCTION

From (ft.)	To (ft.)	Casing Type	Inside Dia.(in)	Outside Dia.(in)	Slot Size(in)	Type	Material
0	16.0	casing	2.00				PLASTIC
0	0	gravel pack					

Top of Casing: ft. below ground

No pump test data for this well.

LOCATION: SW20-25-19W

Well_PID: 51971
 Owner: TOWN OF DAUPHIN
 Driller: Wescan Drilling Ltd.
 Well Name:
 Well Use: TEST WELL
 Water Use:
 UTMX: 422821.146
 UTM Y: 5669647.82
 Accuracy XY: UNKNOWN
 UTMZ:
 Accuracy Z:
 Date Completed: 1984 Jul 01

WELL LOG

From (ft.)	To (ft.)	Log
0	3.0	TILL; SILTY
3.0	14.0	TILL; BROWN, BOULDERS
14.0	16.0	TILL; BLACK
16.0	24.0	SAND; SILTY, SOME WATER AT 21 FEET
24.0	36.0	SHALE; GREY

No construction data for this well.

Top of Casing: ft. below ground

No pump test data for this well.

LOCATION: SW20-25-19W

Well_PID: 51988
Owner: TOWN OF DAUPHIN
Driller: Wescan Drilling Ltd.
Well Name:
Well Use: PRODUCTION
Water Use: Domestic
UTMX: 422821.146
UTMY: 5669647.82
Accuracy XY: UNKNOWN
UTMZ:
Accuracy Z:
Date Completed: 1984 Jul 01

WELL LOG

From (ft.)	To (ft.)	Log
0	3.0	TILL; SILTY
3.0	14.0	TILL; BROWN, BOULDERS
14.0	16.0	TILL; BLACK
16.0	24.0	SAND; SILTY, SOME WATER AT 21 FEET
24.0	30.0	SHALE; GREY

WELL CONSTRUCTION

From (ft.)	To (ft.)	Casing Type	Inside Dia.(in)	Outside Dia.(in)	Slot Size(in)	Type	Material
0	20.0	casing	36.00				
GALVANIZED							
20.0	30.0	perforations	36.00				
GALVANIZED							
0	0	gravel pack					

Top of Casing: ft. below ground

PUMPING TEST

Date:
Pumping Rate: Imp. gallons/minute
Water level before pumping: 4.0 ft. below ground
Pumping level at end of test: ?? ft. below ground
Test duration: hours, minutes
Water temperature: ?? degrees F

REMARKS

CL 125 PPM

Appendix D

Title Page

Plan 1: Site Location Plan with Required Setbacks and Drainage Route

Plan 2: WDG Upgrade and Expansion Site with Test hole Location Plan

Plan 3: Proposed Expansion and Upgrade Layout and Drainage Plan

Plan 4: Dike and Liner Details

Plan 5: Road, Ditch, Fence, Sten Log and Sign Details

CITY OF DAUPHIN

WASTE DISPOSAL GROUND

ENVIRONMENT ACT PROPOSAL

PRELIMINARY
NOT FOR CONSTRUCTION

REDUCED DRAWING SET
DO NOT SCALE

PLAN INDEX

WDG

- PLAN 1.** SITE LOCATION PLAN WITH REQUIRED SETBACKS AND DRAINAGE ROUTE
- PLAN 2.** WDG UPGRADE AND EXPANSION SITE WITH TEST HOLE LOCATION PLAN
- PLAN 3.** PROPOSED EXPANSION AND UPGRADE LAYOUT AND DRAINAGE PLAN
- PLAN 4.** DIKE AND LINER DETAILS
- PLAN 5.** ROAD, DITCH, FENCE, STEN LOG AND SIGN DETAILS

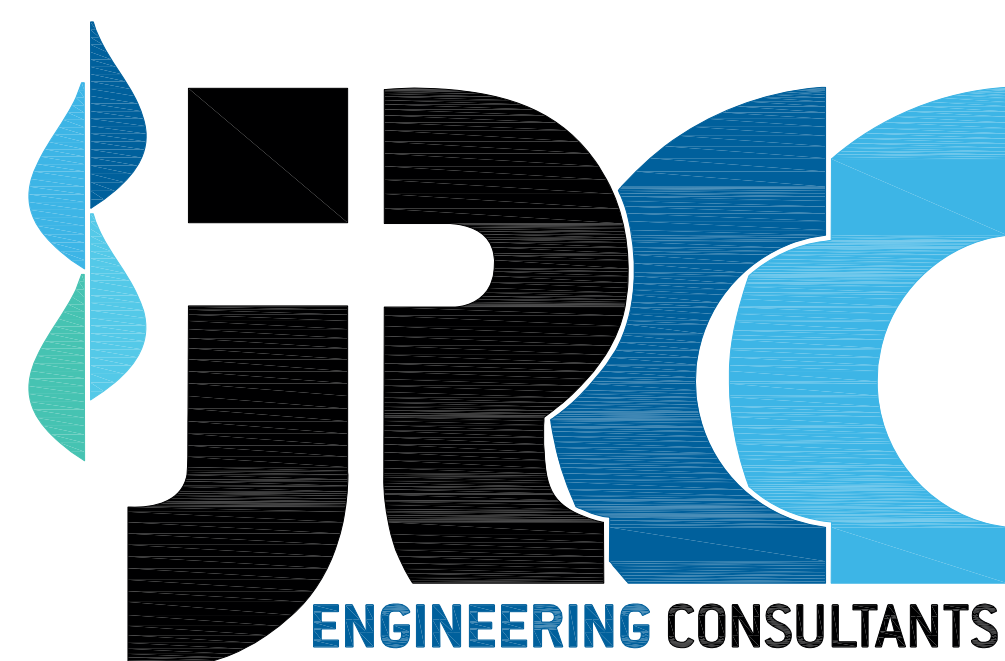

JR Cousin Consultants Ltd.

91A Scurfield Blvd. Winnipeg MB R3Y 1G4

p. (204) 489-0474

f. (204) 489-0487

www.jrcc.ca

ENGINEERING EXCELLENCE SINCE 1981

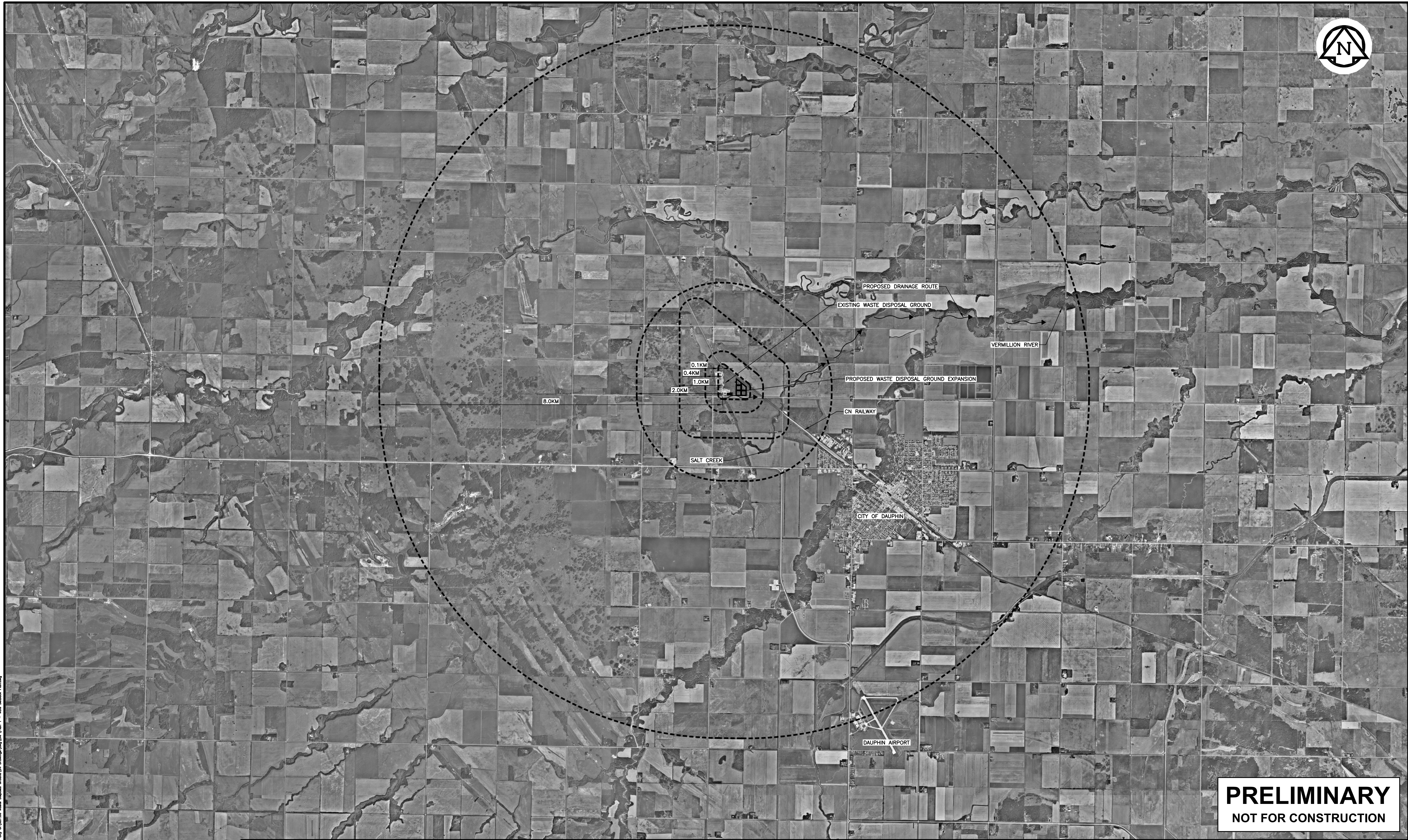

PRELIMINARY
NOT FOR CONSTRUCTION

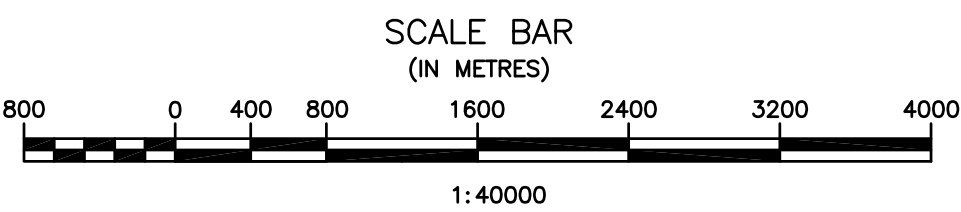

No.	REVISIONS	DATE	INITIALS

B.M. EL.

LOCATIONS OF UNDERGROUND STRUCTURES/UTILITIES AS SHOWN ARE BASED ON AVAILABLE INFORMATION BUT NO GUARANTEE IS GIVEN OR IMPLIED THAT ALL EXISTING UNDERGROUND STRUCTURES/UTILITIES ARE SHOWN OR THAT THE GIVEN LOCATIONS ARE EXACT. CONFIRMATION OF EXISTENCE AND EXACT LOCATION OF ALL UNDERGROUND STRUCTURES/UTILITIES MUST BE OBTAINED FROM THE APPROPRIATE AUTHORITY/OWNER, BY THE CONTRACTOR, BEFORE PROCEEDING WITH CONSTRUCTION.

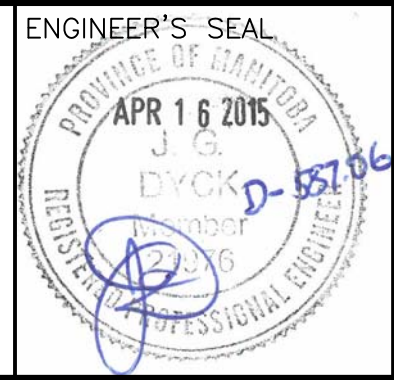
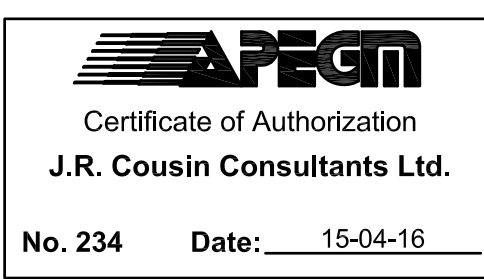

JR Cousin Consultants Ltd.
 91A Scurfield Blvd. Winnipeg MB R3Y 1G4
 p. (204) 489-0474
 f. (204) 489-0487
 www.jrcc.ca

ENGINEERING CONSULTANTS
 ENGINEERING EXCELLENCE SINCE 1981

CODE: D-587.06	PROJECT: CITY OF DAUPHIN WASTE DISPOSAL GROUND EAP
DESIGNED BY: OW	TITLE: SITE LOCATION PLAN WITH REQUIRED SETBACKS AND DRAINAGE ROUTE
DRAWN BY: RH	SCALE: 1:40000
REVIEWED BY: JD	DATE: 14/12/08
	PLAN: 1
	SHEET: 1 of 5

Apr 16, 2015 10:58am P:\000007\Dauphin - City of\001\08 Waste Disposal\Drawings\Site Location Plan 1 - 1000 Sitebook Plot.dwg



EXISTING WASTE DISPOSAL GROUND

CN RAILWAY

PROPOSED WASTE DISPOSAL GROUND EXPANSION

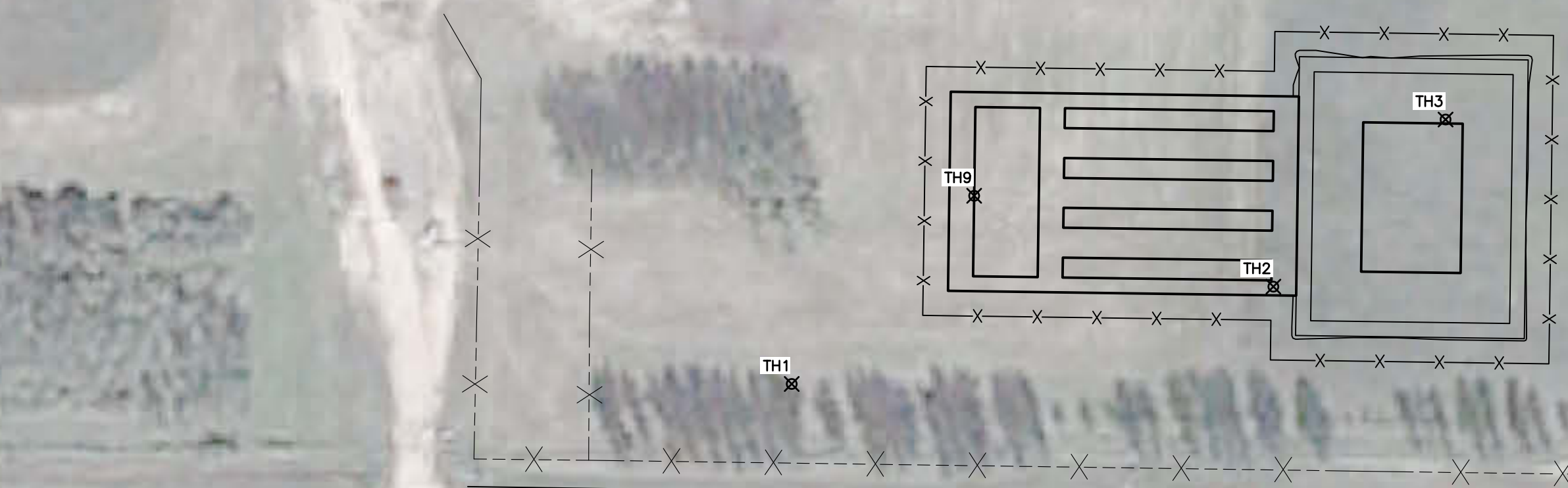

ROAD 147 NORTH

PRELIMINARY
NOT FOR CONSTRUCTION

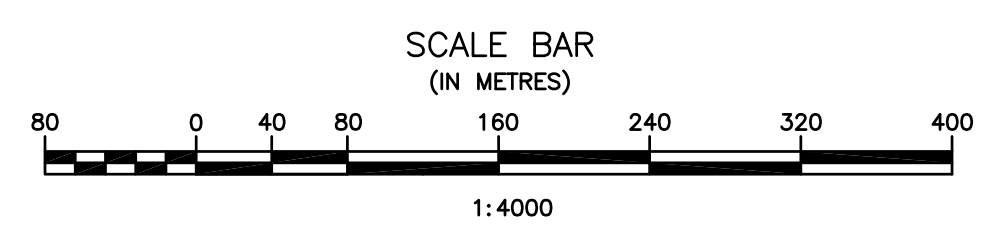

No.	REVISIONS	DATE	INITIALS

B.M. EL.

LOCATIONS OF UNDERGROUND STRUCTURES/UTILITIES AS SHOWN ARE BASED ON AVAILABLE INFORMATION BUT NO GUARANTEE IS GIVEN OR IMPLIED THAT ALL EXISTING UNDERGROUND STRUCTURES/UTILITIES ARE SHOWN OR THAT THE GIVEN LOCATIONS ARE EXACT. CONFIRMATION OF EXISTENCE AND EXACT LOCATION OF ALL UNDERGROUND STRUCTURES/UTILITIES MUST BE OBTAINED FROM THE APPROPRIATE AUTHORITY/OWNER, BY THE CONTRACTOR, BEFORE PROCEEDING WITH CONSTRUCTION.

APEGM
Certificate of Authorization
J.R. Cousin Consultants Ltd.
No. 234 Date: 15-04-16

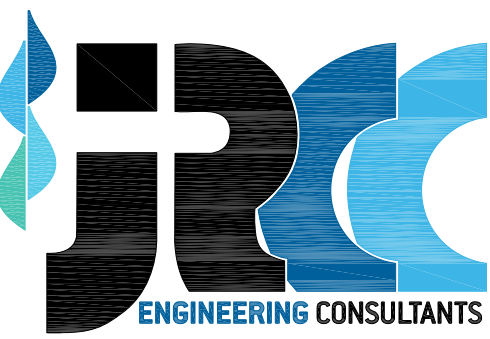
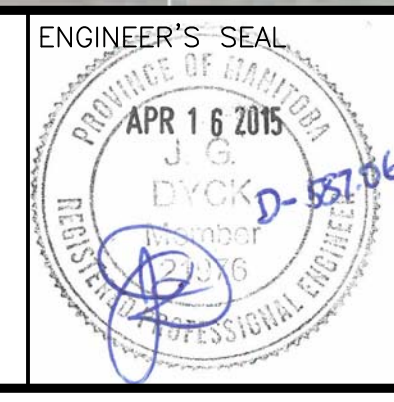

JR Cousin Consultants Ltd.
91A Scurfield Blvd. Winnipeg MB R3Y 1G4
p. (204) 489-0474
f. (204) 489-0487
www.jrcc.ca

CODE: D-587.06	PROJECT: CITY OF DAUPHIN WASTE DISPOSAL GROUND EAP
DESIGNED BY: OW	TITLE: WDG UPGRADE AND EXPANSION SITE WITH TEST HOLE LOCATION PLAN
DRAWN BY: RH	SCALE: 1:4000
REVIEWED BY: JD	DATE: 14/12/08
	PLAN: 2
	SHEET: 2 of 5

Apr 16, 2015 11:00:00 AM - City of Dauphin - Waste Disposal - Drawing - WDG Upgrade and Expansion - Test Hole Location Plan - 2 - Test Hole Location Plan.dwg



PRELIMINARY
NOT FOR CONSTRUCTION

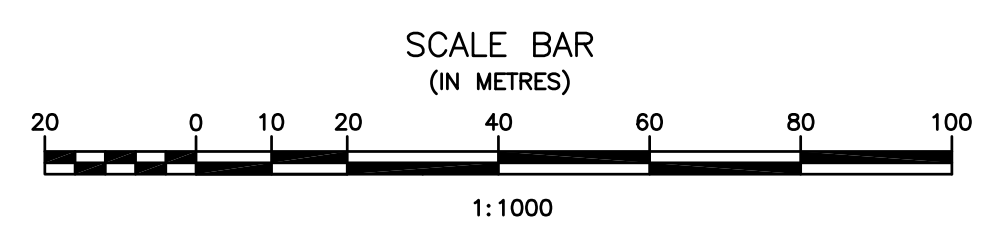

No.	REVISIONS	DATE	INITIALS

B.M. EL.
LOCATIONS OF UNDERGROUND STRUCTURES/UTILITIES AS SHOWN ARE BASED ON AVAILABLE INFORMATION BUT NO GUARANTEE IS GIVEN OR IMPLIED THAT ALL EXISTING UNDERGROUND STRUCTURES/UTILITIES ARE SHOWN OR THAT THE GIVEN LOCATIONS ARE EXACT. CONFIRMATION OF EXISTENCE AND EXACT LOCATION OF ALL UNDERGROUND STRUCTURES/UTILITIES MUST BE OBTAINED FROM THE APPROPRIATE AUTHORITY/OWNER, BY THE CONTRACTOR, BEFORE PROCEEDING WITH CONSTRUCTION.

APEGM
Certificate of Authorization
J.R. Cousin Consultants Ltd.
No. 234 Date: 15-04-16

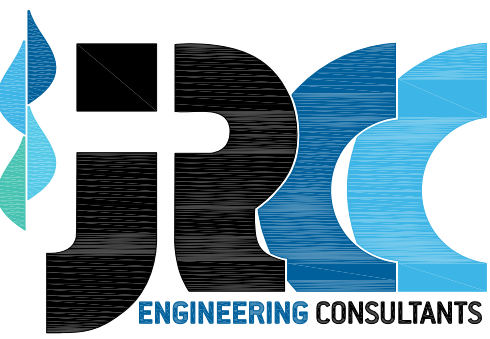
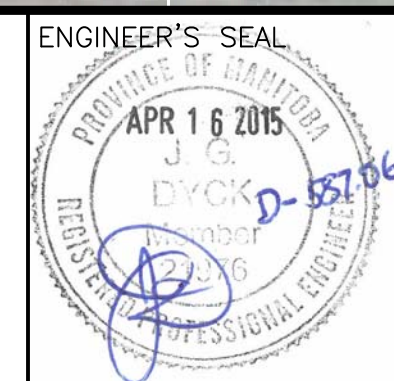





JR Cousin Consultants Ltd.
91A Scurfield Blvd. Winnipeg MB R3Y 1G4
p. (204) 489-0474
f. (204) 489-0487
www.jrcc.ca
ENGINEERING EXCELLENCE SINCE 1981

CODE: D-587.06	PROJECT: CITY OF DAUPHIN WASTE DISPOSAL GROUND EAP
DESIGNED BY: OW	TITLE: PROPOSED EXPANSION AND UPGRADE LAYOUT AND DRAINAGE PLAN
DRAWN BY: RH	SCALE: 1:1000
REVIEWED BY: JD	DATE: 14/12/08
	PLAN: 3
	SHEET: 3 of 5

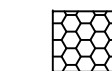
Apr 16, 2015 - 3:27pm P:\000007 - Dauphin - City of Dauphin Waste Disposal - Drawings\04 - Proposed Expansion and Upgrade Layout and Drainage Planning

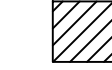
LEGEND:

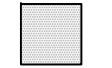
-  EXCAVATED AND COMPACTED CLAY TYPE SOIL
-  SCARIFIED 150mm AND COMPACTED CLAY TYPE SOIL
-  EXCAVATED AND COMPACTED SOIL MATERIAL
-  EXCAVATED AND COMPACTED MIXTURE OF ORGANIC AND INORGANIC SOILS
-  TOPSOIL
-  INSITU
-  ASPHALT MILLINGS

LEVEL 1 - PRE-CONSTRUCTION EXISTING PRAIRIE ELEVATION
 LEVEL 2 - ELEVATION FOLLOWING STRIPPED ORGANICS/VEGETATION
 LEVEL 3 - FINISHED CELL BOTTOM ELEVATION
 LEVEL 2 AND 3 - TO BE COMPACTED WITH SHEEPSFOOT PACKER
 LEVEL 4 - BOTTOM OF LINER

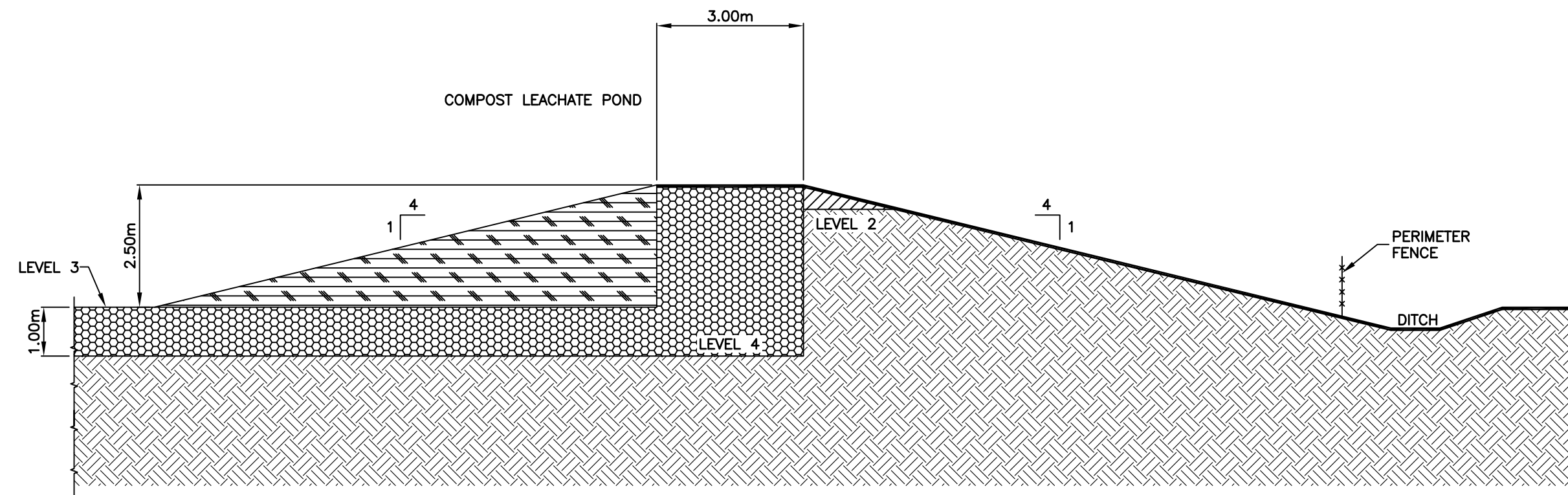

1 TYPICAL COMPOST LEACHATE POND PERIMETER DIKE
 SCALE = 1:100

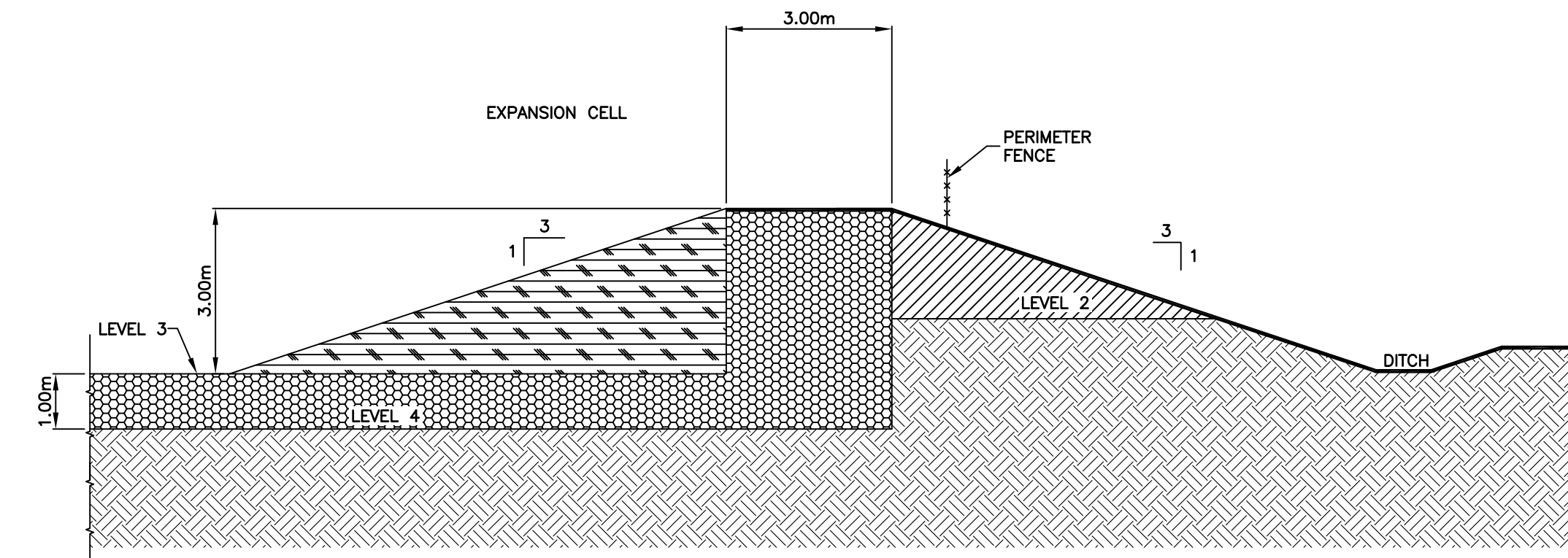

2 TYPICAL EXPANSION CELL PERIMETER DIKE
 SCALE = 1:100

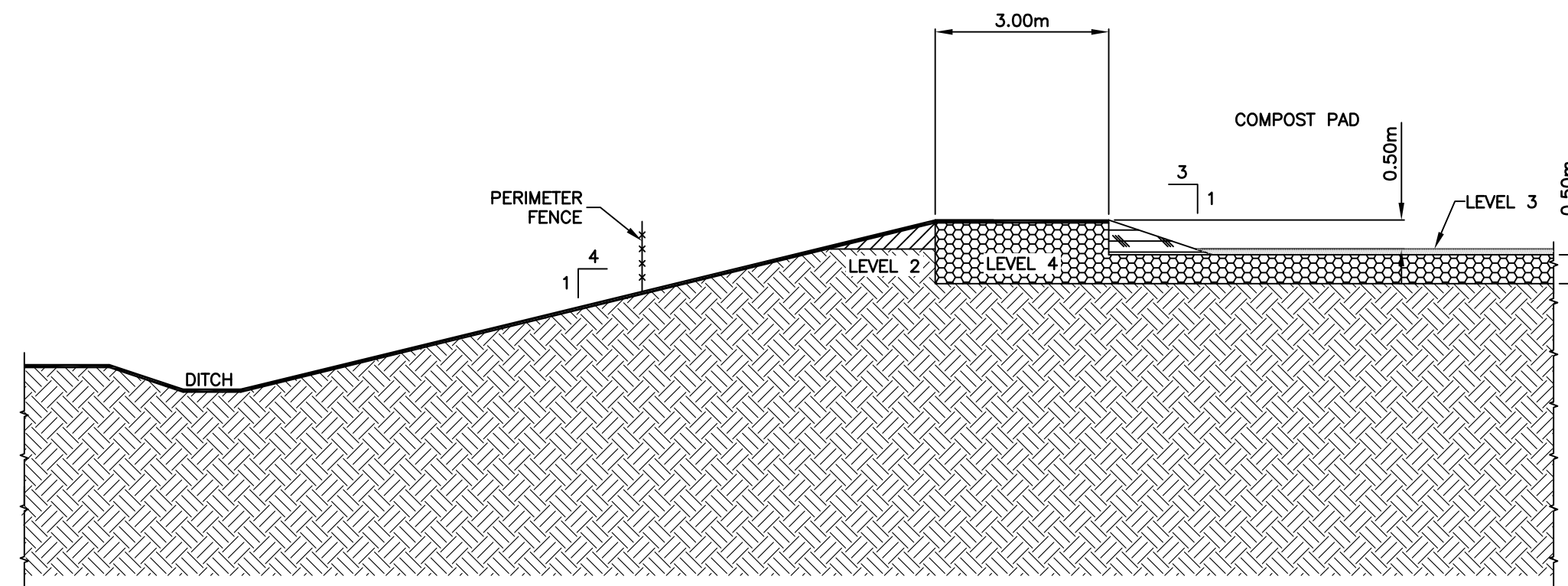

3 COMPOST PAD DETAIL
 SCALE = 1:100

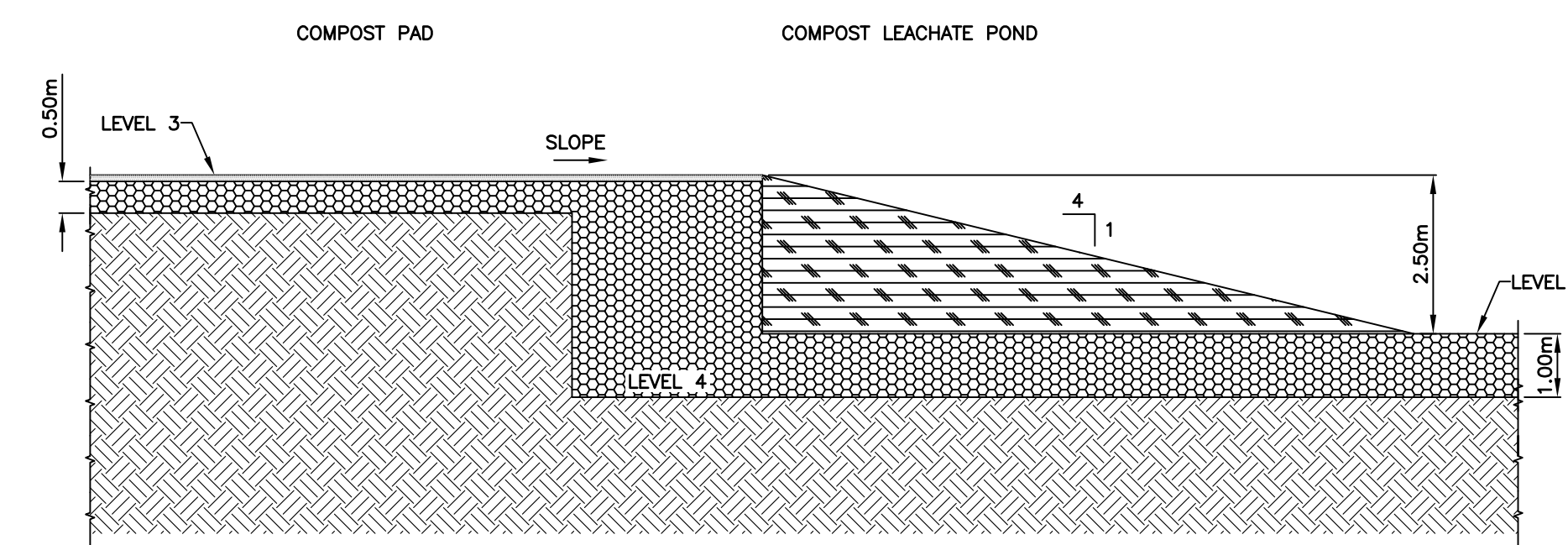

4 COMPOST PAD TO LEACHATE POND DETAIL
 SCALE = 1:100

PRELIMINARY
 NOT FOR CONSTRUCTION

No.	REVISIONS	DATE	INITIALS	B.M. EL.

LOCATIONS OF UNDERGROUND STRUCTURES/UTILITIES AS SHOWN ARE BASED ON AVAILABLE INFORMATION BUT NO GUARANTEE IS GIVEN OR IMPLIED THAT ALL EXISTING UNDERGROUND STRUCTURES/UTILITIES ARE SHOWN OR THAT THE GIVEN LOCATIONS ARE EXACT. CONFIRMATION OF EXISTENCE AND EXACT LOCATION OF ALL UNDERGROUND STRUCTURES/UTILITIES MUST BE OBTAINED FROM THE APPROPRIATE AUTHORITY/OWNER, BY THE CONTRACTOR, BEFORE PROCEEDING WITH CONSTRUCTION.

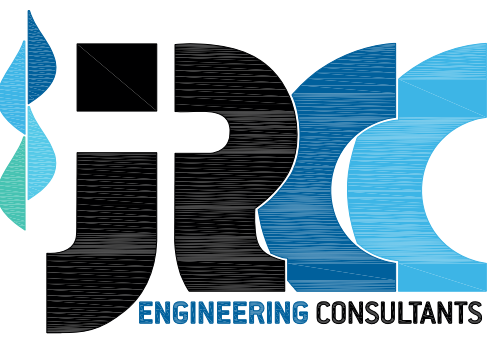
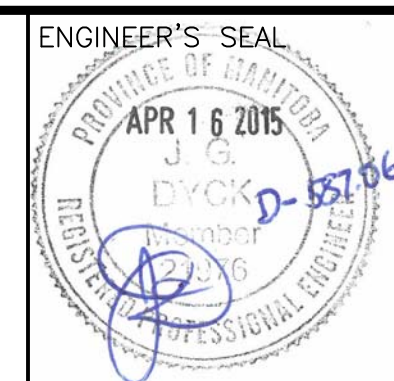

JR Cousin Consultants Ltd.
 91A Scurfield Blvd. Winnipeg MB R3Y 1G4
 p. [204] 489-0474
 f. [204] 489-0487
 www.jrcc.ca

CODE: D-587.06	DESIGNED BY: OW	DRAWN BY: RH	REVIEWED BY: JD	PROJECT: CITY OF DAUPHIN WASTE DISPOSAL GROUND EAP	TITLE: DIKE AND LINER DETAILS	SCALE: AS NOTED	DATE: 14/12/08	PLAN: 4	SHEET: 4 of 5
----------------	-----------------	--------------	-----------------	--	-------------------------------	-----------------	----------------	---------	---------------

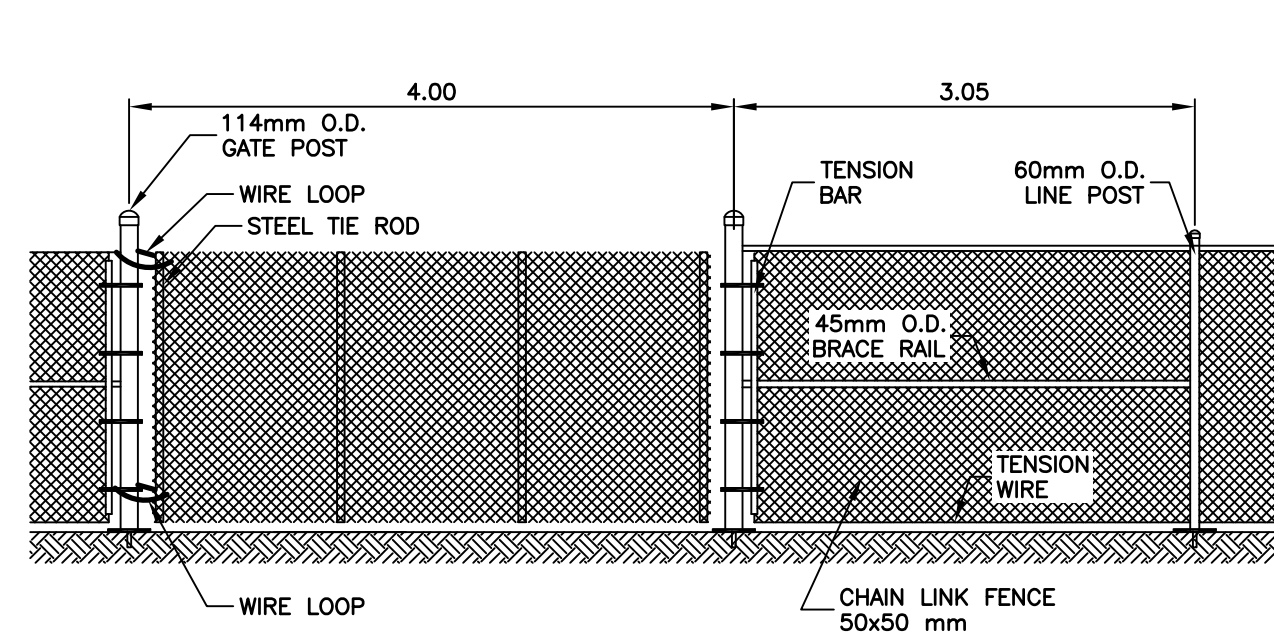

1 EXPANSION CELL FENCE AND GATE DETAIL
SCALE = 1:50

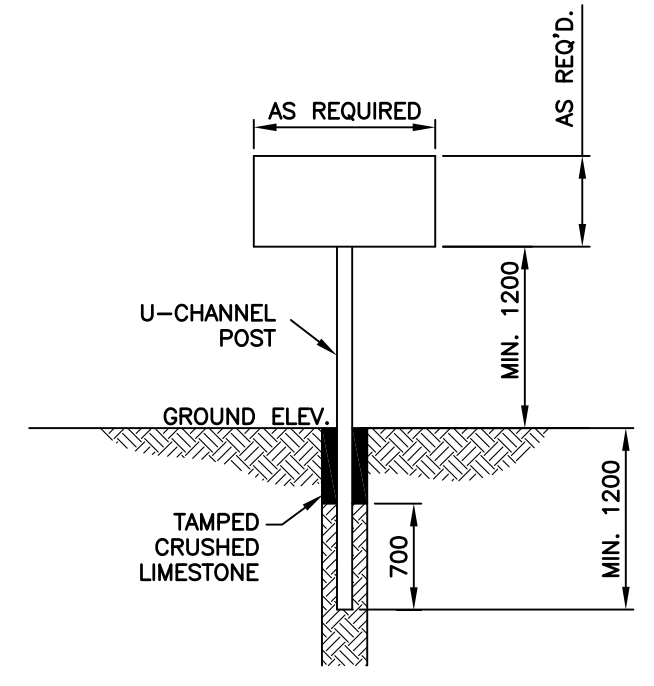

4 SIGN DETAIL
SCALE = 1:50

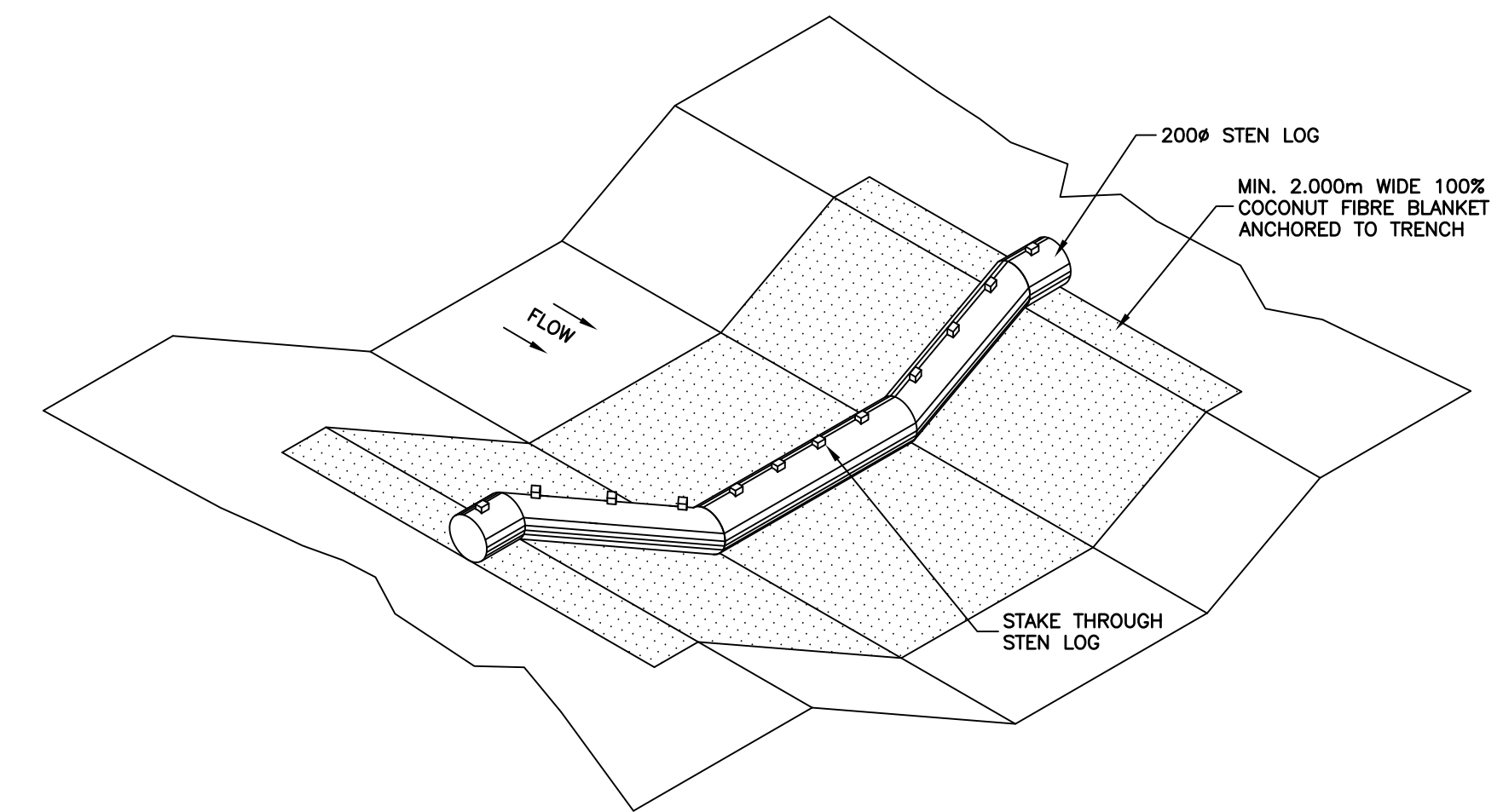

5 STEN LOG DETAIL
SCALE = 1:30

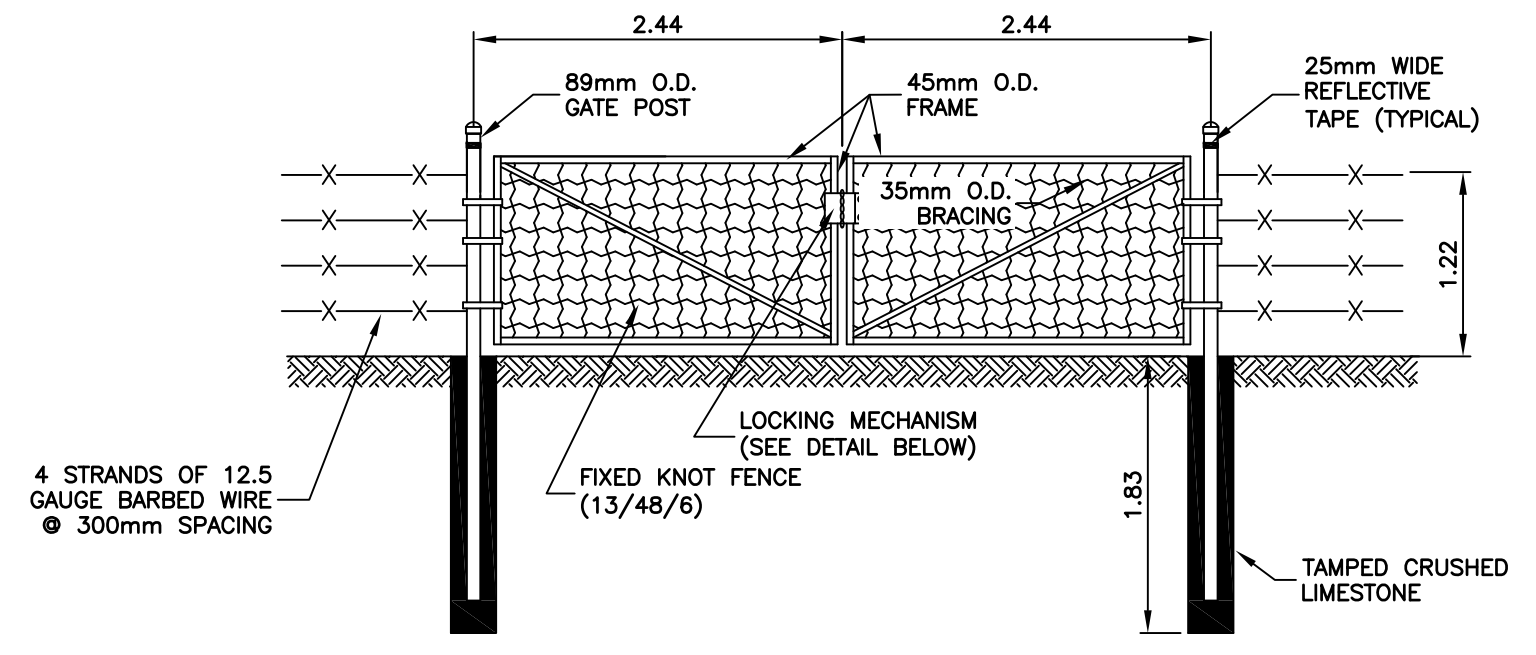

2 COMPOST PAD AND LEACHATE POND GATE DETAIL
SCALE = 1:50

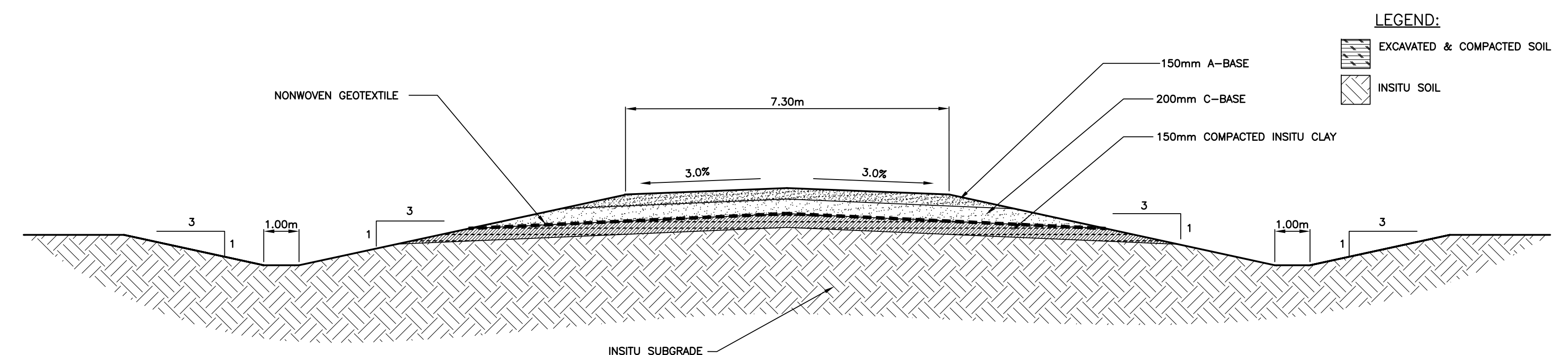

6 APPROACH ROAD CROSS-SECTION
SCALE = NTS

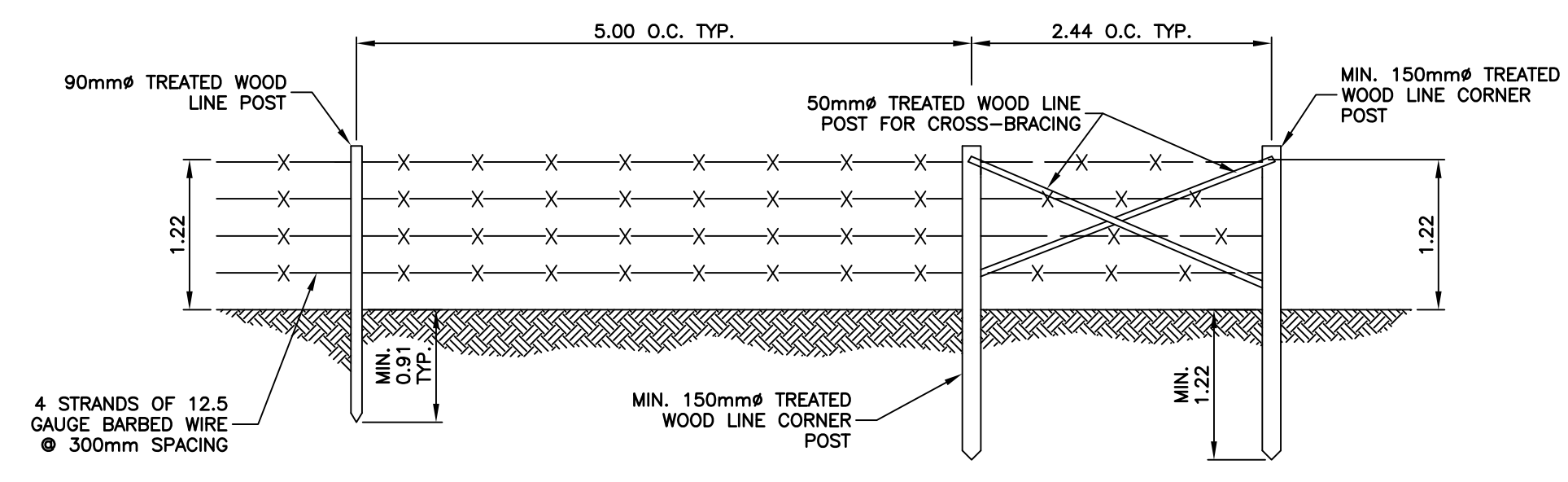

3 COMPOST PAD AND LEACHATE POND CORNER FENCE DETAIL
SCALE = 1:50

NOTE:
- PROVIDE CROSS BRACING AT CORNER POSTS IN BOTH DIRECTIONS.
- SHOWN DIAMETER REFERS TO SMALLEST END OF POST.

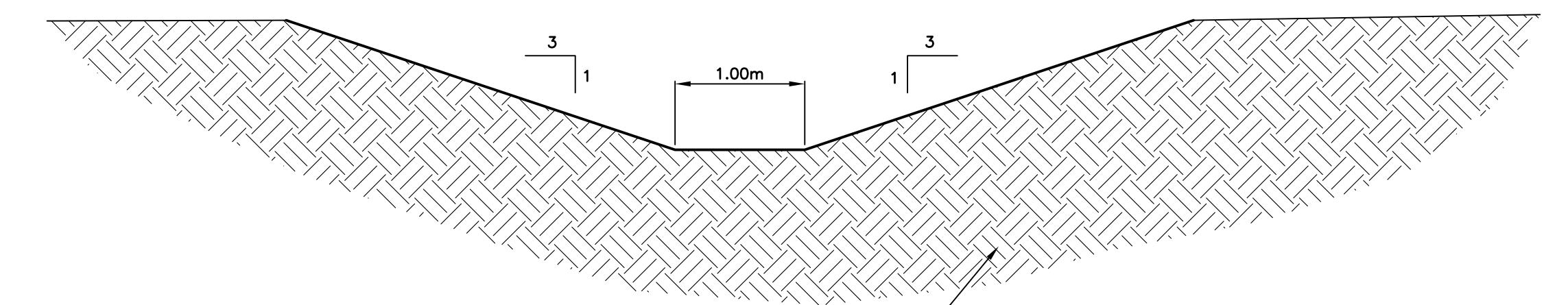

7 TYPICAL DITCH CROSS-SECTION
SCALE = NTS

PRELIMINARY
NOT FOR CONSTRUCTION

No.	REVISIONS	DATE	INITIALS	B.M. EL.

LOCATIONS OF UNDERGROUND STRUCTURES/UTILITIES AS SHOWN ARE BASED ON AVAILABLE INFORMATION BUT NO GUARANTEE IS GIVEN OR IMPLIED THAT ALL EXISTING UNDERGROUND STRUCTURES/UTILITIES ARE SHOWN OR THAT THE GIVEN LOCATIONS ARE EXACT. CONFIRMATION OF EXISTENCE AND EXACT LOCATION OF ALL UNDERGROUND STRUCTURES/UTILITIES MUST BE OBTAINED FROM THE APPROPRIATE AUTHORITY/OWNER, BY THE CONTRACTOR, BEFORE PROCEEDING WITH CONSTRUCTION.

APECM
Certificate of Authorization
J.R. Cousin Consultants Ltd.
No. 234 Date: 15-04-16

ENGINEER'S SEAL
APR 16 2015
J.R. Cousin
Professional Engineer

JR Cousin Consultants Ltd.
91A Scurfield Blvd. Winnipeg MB R3Y 1G4
p. (204) 489-0474
f. (204) 489-0487
www.jrcc.ca
ENGINEERING EXCELLENCE SINCE 1981

CODE: D-587.06	PROJECT: CITY OF DAUPHIN WASTE DISPOSAL GROUND EAP
DESIGNED BY: OW	TITLE: ROAD, DITCH, FENCE, STEN LOG AND SIGN DETAILS
DRAWN BY: RH	SCALE: AS NOTED
REVIEWED BY: JD	DATE: 14/12/08
	PLAN: 5
	SHEET: 5 of 5

Apr 16, 2015 - 4:02pm (1:00:00) Desktop - City of Dauphin - Waste Disposal - Drive/Highway/Map/View - Road Ditch Fence and Sign Detailing

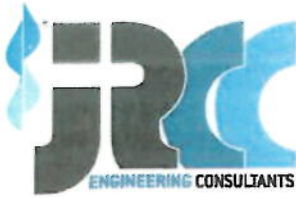

May 18, 2016

Ms. Cory Switzer, P.Eng.
Environmental Approvals Branch
Manitoba Sustainable Development
123 Main Street, Suite 160
Winnipeg, Manitoba
R3C 1A5



D-587.06

Dear Ms. Switzer,

RE: City of Dauphin – Waste Disposal Ground Upgrade and Expansion – Environment Act Proposal

Attached are responses to the comments and requests for additional information as forwarded to JR Cousin Consultants Ltd. (JRCC) from Cory Switzer at Manitoba Conservation and Water Stewardship on December 21, 2015, regarding the *City of Dauphin, Waste Disposal Ground Upgrade and Expansion Environment Act Proposal*.

1. "Develop an Operating Plan, a Contingency plan in event contamination found in soils, groundwater, and an Emergency Plan (these will be licence conditions, they do not need to be completed prior to issuance of a Licence)."

The City of Dauphin is aware of the requirement for an Operating Plan and Emergency Plan, and will work on addressing this after the Environment Act Licence is issued.

2. "Provide additional information about site surface water drainage, monitoring, control and storage."

Section 2.5.9.9 and plan 3 of the EAP describes drainage characteristics of the proposed ditching around the expansion cells and compost area. The above grade berms and dikes proposed in the expansion would direct surface water away from the cells into perimeter ditching. The surface water accumulated on the existing WDG site, from precipitation, is graded to ditching along the interior access roads which flows south to the ditch along Road 147 N. Any capped cells at the site would have positive drainage away from the cell towards the perimeter ditching. Surface water is not currently stored or monitored onsite.

3. "Provide additional information about the groundwater (quality, quantity, depth to usable aquifer, etc)."

Section 2.5.6.1 and 2.5.6.4 describe the depth to the shallow groundwater table in the existing monitoring wells at the WDG site. The City of Dauphin does not have water quality data from these monitoring wells and past sampling from these wells has not occurred. Based on previous Driller Well Logs for the quarter section where the WDG is located, the aquifer consisted of sand and shale and was located at a depth of 6.0 m to 9.1 m below the surface. Based on groundwater availability mapping for the area, the nearest exploratory well to the WDG site, at SE 24-25-20 WPM, the aquifer tested consisted of sand and sandstone located at the shallowest depth of 8.8 m below the surface. The aquifer tested was in the shale and sandstone layers at a depth of 22 m to 25 m and was pumped at a rate of 3.75 imp. gallons/minute. This testing occurred in 1970.

4. "Describe the construction of the former (closed and current active cell, any leachate management systems installed)."

The existing cells on the site were not built to any formal specification, however from discussion with the City of Dauphin, the former and active cells were constructed to a depth of 1.8 m to 2.1 m below the surface in native (in situ) soils, with berms surrounding the cells. There were no leachate management systems installed in the former or existing waste disposal cells. The decommissioned cells on the west side of the WDG site were capped with sludge from the nearby Dauphin wastewater treatment lagoon under a provincial permit. Currently the waste disposal cells on the east side of the WDG site have not been capped, however the contaminated soils area is located on top of a former waste disposal cell on the northern portion of the site, as indicated on Plan 2 of the EAP Addendum.

5. "Describe the monitoring currently occurring for all closed cells (regarding leachate levels, settlement, landfill cap integrity, leachate seeps, etc.)."

There is no subsurface monitoring of closed cells on the site with regards to leachate levels. The site operators do conduct visual inspections of the surfaces of the closed cells to identify any abnormalities. If any seepage from the cap or noticeable settlement occurs, the site operators would conduct more detailed investigations.

6. "Describe proposed monitoring wells to be installed around the closed cells as well as the new cells."

The proposed monitoring wells will be installed at the locations shown on Plan 3 of the EAP. Section 2.5.9.4 of the EAP describes the location and depth of the proposed monitoring wells. The slotted portion of the wells will be located in the permeable sand layer of the soils and will extend to a depth below the closed and expansion cell floor elevations to capture any potential contaminated groundwater flows. Additional monitoring wells can be placed around the perimeter of the closed cells. Approval from Manitoba Conservation will be obtained for location and number of wells to be installed during the design phase of the project.

7. "Provide the results of the monitoring well samples that have been taken."

No past monitoring well sampling has occurred at the WDG site.

8. "Develop a leachate management system for the proposed cells, to include at minimum collection, removal, conveyance and storage/or treatment or alternative management system for leachate."

A leachate management system will be developed for the proposed expansion cells, which will include leachate collection piping in the floor of the expansion cells, and a dedicated leachate evaporation pond. The leachate collection piping would flow by gravity to a manhole and from this manhole the operator would manually pump leachate to the leachate pond. The pond would be sized for liquid accumulation on the active portion of the waste disposal ground and precipitation falling directly on the leachate pond. The Environment Canada data for precipitation and evapotranspiration for the area would be utilized in the sizing of the leachate pond. The attached plan shows the revised site layout with an area identified for the leachate collection and storage pond, adjacent to the compost leachate evaporation pond.

9. **“Provide additional information about the fish disposal pit (sizing, lining, frequency of cover, any additives utilized for odour, operational parameters, volumes of waste received).”**

The fish disposal pit identified on Plan 2 of the EAP Addendum should be amended to be called a pit for “animal mortalities”, not simply for fish. The requirements of the existing operating permit for accepting animal mortalities would continue to be followed, which includes covering with one metre of earthen cover within 24 hours of any disposal. Plan 2 of the EAP Addendum has been updated and attached. This existing pit is located in a closed cell on the west side of the site and was excavated to a depth of approximately 2.0 m. From discussion with the site operator, this animal mortalities pit is used approximately once or twice per month.

10. **“Provide authorization of used oil collection and pesticide container depot under Dangerous Goods Handling and Transportation Act.”**

Used oil is not accepted at the site, as the City of Dauphin has another location intended for drop off, however a used oil tank is located at the site for WDG equipment maintenance only. The used chemical container compound is operated under registration No. MB3001133, issued by Manitoba Environment and Workplace Safety and Health on December 28, 1990 (see attached).

11. **“Provide information regarding the Contaminated Soils Area (treatment base and containment information, drainage/storage of surface water from land farm, type of soils accepted, limits, volumes, processing/treatment description).”**

The contaminated soils cell is located on top of a former waste disposal cell in the north portion of the WDG site and has a footprint of approximately 11,000 m². This cell area is surrounded by an earthen berm on all sides which contains leachate within this cell. The soils accepted include, but are not limited to hydrocarbon contaminated soils and are tested in accordance with Manitoba Guidelines 96-05 and CCME standards prior to utilizing as cover material for the waste disposal cells. The soils are typically left to decontaminate for approximately 2 to 3 years with intermittent surface mixing for aeration. This contaminated soils cell was approved by Manitoba Conservation in accordance with Order No. D1-176 on October 15, 2010 (see attached).

12. **“Provide description, use, types of materials separated, etc. for the Shingle and Construction Waste Storage area.”**

The shingles are placed in the active waste disposal cell. Untreated lumber is placed in the burn cells. Concrete waste material is separated based on whether it contains rebar or not and is stored in the northwest corner of the property on top of a closed cell.

13. **“Provide a copy of the Geoenvironmental Investigation Livestock Disposal Site – Dauphin, MB by UMA 2008 and any other relevant previous geotechnical reports including the 2011 geoenvironmental investigation report.”**

There is no 2011 Geoenvironmental Investigation report, this should be corrected in Section 2.5.6.4 of the EAP to read “the 2008 Geoenvironmental Investigation Report”. The 2008 Geoenvironmental Investigation report has been attached.

14. "Provide additional information on the Composting facility."

a. Listing of feedstock to be included in licence

- The compost area will receive grass, leaves and garden materials

b. Listing of bulking materials

- Woodchips obtained from the City would be used as a bulking agent

c. Clarification if compost pad already constructed, as identified in 1.6 of addendum page 1 of 2 or to be constructed as per 2.5.7 of page 2-13

- There is a temporary compost area already in use at the site, however a new compost pad is proposed in Section 2.5.7 of the EAP, which will allow for greater capacity and control of composting process. As well as containing leachate generated from the compost.

d. What is the proposed end use of compost

- The composted end product will be utilized for planting beds in the City of Dauphin, if it meets CCME standards, and also for waste disposal cell cover material. If CCME standards can be met, then the material may be offered to residents, depending on quantity available.

e. Identify what is meant by 'after hours drop off location', the type of containers or liner in place and the length of time raw feedstock would remain at this location

- The 'after hours drop off area' is a cleared and fenced area at the entrance to the WDG site utilized by residents for dropping off compost material from 7 pm to 8 am and all day on Sunday, while the site is closed. This drop off area is not lined, and the material is removed from this area daily, while the site is operating (Monday thru Saturday). The longest amount of time compost material is left in this area would be approximately 36 hours (between Saturday evening and Monday morning).

f. Operational practices

- Section 2.5.12.2 of the EAP describes operational practices at the proposed compost area. In addition, the City intends on purchasing a compost turner in the future. It is intended that the compost will be turned approximately every two to three weeks for aeration.

15. "Provide additional information regarding the new cell construction – water present at a depth above the depth of the cut off wall and cell base are to be established, has dewatering been considered for construction? What is to be done if there is not sufficient high plastic clay to line the cells, the leachate pond, the compost pad etc?"

In the test holes conducted, water infiltration was noted at depths of 1.2 m to 2.6 m below the surface, which will impact construction works, however the construction contractor will be made aware of these conditions and will be prepared to dewater the excavation as necessary to rework the liner, as described in Section 2.5.9.3 of the EAP. If sufficient high plastic clay is not available from the expansion cell and leachate pond excavations, then borrow soil materials will need to be hauled to the site from a nearby borrow pit.

16. "Explain the difference of the conclusion of suitability between the results from Stantec of TH2 1.2 – 2.9 m and TH7 1.2 – 2.4 m from Aug. 26, 2014 report and the Oct. 6, 2014 report."

The initial analysis of the soil characteristics indicated that these samples (TH2 1.2 – 2.9 m and TH7 1.2 – 2.4 m) had relatively high clay and silt contents, however the laboratory classified them as low plastic and unlikely to achieve a hydraulic conductivity of 1×10^{-7} cm/sec or less, based on the plasticity index (less than 25) and clay content (less than 50%). However, after reworking these soils, the hydraulic conductivity results were less than 1×10^{-7} cm/sec. As described in Section 2.5.6.2 of the EAP, testing of hydraulic conductivity with an in situ Shelby tube or by reworking a bulk sample is a more accurate representation of predicting hydraulic conductivity under field conditions, rather than basing the conclusions on results of plasticity index and clay content from bagged samples alone. The bagged samples provide a basic estimate of the soil conditions, but permeability testing is a more accurate and reliable method for estimating liner conditions.

I trust the enclosed responses sufficiently address the comments and requests for additional information. If you have any concerns or additional requirements, please contact the undersigned.

Sincerely,

JR Cousin Consultants Ltd.



Oswald Wohlgemut, M.Sc.
Environmental Scientist

Reviewed by



Jeff Dyck, P.Eng.
Senior Municipal Engineer

cc Bill Brenner, City of Dauphin, via email





Town of Dauphin
21 - 2nd Avenue N.W.
Dauphin, Manitoba
R7N 1H1

December 28, 1990

Attention: Mr. A. G. Dmitruk
Secretary Treasurer

Dear Mr. Dmitruk:

**Re: Pesticide Container Collection Depot
Town of Dauphin**

Please find enclosed the operating order for the pesticide container collection depot located within the Town of Dauphin. The Provincial Registration number assigned to the depot located at Part SW 1/4 20-25-19 WPM as a hazardous waste facility is MB3001133.

The inspection information for the site indicates that the depot is not in compliance with a number of items listed in the order. Please ensure that these deficiencies are corrected such that the facility is in compliance with the order for the 1991 operating season.

As stated in Clause 14 of the order the Town of Dauphin may apply for a variance to the order if it considers that the improvements to the depot are not necessary.

Your attention to this matter is appreciated.

Yours truly,

Bernard J. Crisp
Regional Director

BJC:ls

Enclosure

**HAZARDOUS WASTE MANAGEMENT FACILITY
OPERATING ORDER**

Issued by the Manitoba Department of Environment to Town of Dauphin pursuant to The Dangerous Goods Handling and Transportation Act for the operation of a pesticide container collection depot located Part SW $\frac{1}{2}$ 20-25-19 WPM.

Approval is hereby granted for the operation of the facility described above, subject to the following terms and conditions:

1. The facility shall only be used to store containers which were last used to contain agricultural pesticide products registered under the Pest Control Products Act of Canada.
2. The depot shall be located on soil formations which will prevent percolation of contaminants into groundwater. Where local soils are not adequate to protect groundwater, the storage must be upgraded with the addition of either a clay or a synthetic membrane liner. The Department may issue specific instructions on sites which require upgrading for the purpose of groundwater protection.
3. The depot and surrounding land must be graded, channelled or bermed in order to:
 - a) prevent drainage or runoff from the surrounding area from entering the storage site, and
 - b) prevent drainage or runoff from leaving the storage site.
4. The area within the depot shall be graded to a sump capable of containing any accumulated precipitation and/or pesticide residues.
5. The depot shall be surrounded by a fence capable of retaining all containers stored within the facility and separating the storage area from the surrounding land usage.
6. An all-weather road shall be maintained for access to the depot.
7. The depot shall be at least 500 meters from a residence or a body of surface water and at least 100 meters from a waterwell.
8. A fire break area shall be maintained outside of the perimeter fence to prevent the spread of a grass or garbage fire into the depot.
9. Separate areas shall be designated within the depot for the storage of metal and plastic containers.

10. Signs shall be posted at all entrances to the depot identifying it as a pesticide container depot and providing instructions to users of the facility on how and where to deposit containers. The sign should also display a 24 hour emergency number for contacting the owner of the depot. All signs posted at the depot must be constructed of weather resistant materials and must be legible from a distance of at least 10 meters.
11. Accumulated containers shall be removed from the depot at least once per year.
12. Any liquid accumulated at the depot from rinsing or draining of containers shall be stored in 205 L drums which meet CTC Specification 17E. Drums shall be removed from the depot in accordance with applicable hazardous waste legislation. Drums containing liquid residues shall not be stored at the depot during periods when freezing temperatures may reasonably be expected for more than 24 hours.
13. Any pesticide containers being removed from the depot must comply with applicable hazardous waste legislation unless:
 - a) the material last contained in the container is not listed as a dangerous good in the federal Transportation of Dangerous Goods Regulations or does not meet the criteria specified in the Regulations, or
 - b) pesticide residues have been removed from the container in a manner acceptable to the Department.
14. The Department may, upon receipt of a request from the operator of a facility affected by this order, vary any of the specific provisions of the order if the applicant can show that the variance will not result in a lesser degree of environmental protection.
15. The Department may require the operator of a facility affected by this order to conduct contaminant studies of the depot during the operation or upon closure of the site.
16. The party identified as the operator of the depot is considered to be responsible for complying with the conditions of this order. The owner of the land on which the depot is located will be deemed to be the operator unless the owner can provide the Department with written evidence that another party has assumed responsibility for operation and for ensuring compliance with this order.

Registration Number: MB3001133

Dated this 20th day of December, 1990

Director

PESTICIDE CONTAINER COLLECTION : EPOT

Inspection Check List

Location SW 1/4 20-25-19 Inspection Date Sept 13/90
 Operator Town of Dauphin Inspector P. Spobel

	YES	NO
<i>(Include comments on each section, where applicable)</i>		
1. Depot used for pesticide containers only <i>separate depot within WDG.</i>	X	
2. a) Has an impermeable base been installed?		
b) Does groundwater hazard appraisal identify the site as a pollution hazard area?		
3. Are drainage control features in place?	X	
4. Is collection sump in place within depot?		X
5. Is adequate fencing up around storage area?	X	
6. Does depot have an all-weather access road?	X	
7. a) Is depot at least 500 m from residence or surface water?	X	
b) Is depot at least 100 m from a water well?	X	
8. Is a fire break in place around the depot?		
9. Are metal and plastic containers segregated?	X	
10. Are proper signs posted at depot entrance?	X	
11. Are accumulated liquids and residues stored in proper drums?		

General Comments:

09.05.10

COPY

THE DANGEROUS GOODS HANDLING and
TRANSPORTATION ACT
LA LOI SUR LA MANUTENTION ET LE TRANSPORT
DES MARCHANDISES DANGEREUSES



ORDER / ORDRE

Order No. / N° de l'ordre D1-176

Issue Date / Date de délivrance October 15, 2010

In accordance with The Dangerous Goods Handling and Transportation Act (C.C.S.M. c. D12) /
Conformément à la Loi sur la manutention et le transport des marchandises dangereuses (C.P.L.M. c. D12)

THIS ORDER IS ISSUED TO:/CET ORDRE EST DONNÉ À:

The City of Dauphin
100 Main Street South
Dauphin MB R7N 1K3

IN THIS ORDER:

“The Act” means The Dangerous Goods Handling and Transportation Act (C.C.S.M.c.D12).

“Contaminant(s)” means any solid, liquid, gas, waste, radiation or any combination thereof that is foreign to or in excess of the natural constituents of the environment and

- (a) that affects the natural, physical, chemical or biological quality of the environment, or
- (b) that is or is likely to be injurious or damaging to the health or safety of a person.

“Director” means Don Labossiere, a Director of Manitoba Conservation, as designated by the Minister of Conservation within The Dangerous goods Handling and Transportation Act.

“Subject site” means the Soil Treatment Facility located at the City of Dauphin Waste Disposal Ground in Dauphin, Manitoba and legally described as S.W. quarter Section 20, Township 25, Range 19 WPM.

WHEREAS the City of Dauphin has submitted an application for a Soil Treatment Facility located at the Dauphin Waste Disposal Ground the Subject Site to treat petroleum contaminated soils;

AND WHEREAS the soils being treated may be impacted with petroleum hydrocarbons, heavy metals, and other contaminants and may cause significant adverse effect on an area of the environment;

AND WHEREAS the City of Dauphin is legal owner of the Subject Site;

AND WHEREAS under Section 16(3) of the Act, the Director may require a person to carry out such measures as considered necessary to prevent contamination or secure the affected areas and the environment affected by it, including monitor, measure, contain, remove, store, or otherwise dispose of contaminants;

The City of Dauphin
Director Order #D1-176

PURSUANT TO SECTION 16(3) OF THE ACT, I HEREBY ORDER The City of Dauphin to do the following:

1. The City of Dauphin shall ensure that the Soil Treatment Facility is operated in accordance with Manitoba Guideline 96-05 *Treatment and Disposal of Petroleum Contaminated Soil revised April 2002* and the terms and conditions of this Order.
2. The City of Dauphin shall ensure that impacted soil is placed only within the Soil Treatment Cell (hereafter referred to as the Cell) and that impacted soil is placed in such a manner so as to prevent overflow of soil or run-off water from the Cell.
3. All berms surrounding the Cell shall be at least 0.5 metres above the level of the impacted soil at the edges of the Cell in order to contain any run-off water.
4. The City of Dauphin shall ensure that all run-off water and leachate from soils in the Cell are contained within the Subject Site.
5. The City of Dauphin shall ensure that confirmatory sampling is conducted in accordance with Manitoba Guidelines 96-05. Prior to the removal of any soil from the Cell, results of confirmatory sampling shall be provided to Manitoba Conservation for review and approval.

In accordance with Section 22 of The Act, if any of the requirements of this Order are not complied with, in my capacity as Director I may cause to be done, at any time, any or all things required by the Order and I may issue to the City of Dauphin an Order to pay the costs of anything caused to be done.

Date: Oct 25 2010



Don Labossiere
Director

Served by: _____

Received by: _____



No.	REVISIONS	DATE	INITIALS

B.M. EL.

APQM
 Certificate of Authorization
 J.R. Cousin Consultants Ltd.
 No. 234 Date: 16-05-18

ENGINEER'S SEAL
 J.R. COUSIN
 M.A.S.T. 21070

JR
 ENGINEERING CONSULTANTS
 ENGINEERING EXCELLENCE SINCE 1981

JR Cousin Consultants Ltd.
 814 Scurlfield Blvd, Winnipeg MB R3T 1G4
 P: (204) 489-0474
 F: (204) 489-0487
 www.jrc.ca

PROJECT: CITY OF DAUPHIN
 WASTE DISPOSAL GROUND EXP

DESIGNED BY: OW
 DRAWN BY: RH
 REVIEWED BY: JD

TITLE: PROPOSED EXPANSION AND UPGRADE LAYOUT AND DRAINAGE PLAN

SCALE: 1:1000
 DATE: 14/12/08
 PLAN: 3
 SHEET: 3 of 5

PRELIMINARY
 NOT FOR CONSTRUCTION