

# Vale

## 2022 Precipitate Management SOW

**SUBMITTED BY:**  
**Bryn Olafson B. Env. Sc.**  
**February 11, 2022**

Revision 01: February 18, 2022

Revision 02: March 7, 2022



# SECURE

120, 8832 BLACKFOOT TRAIL SE.,  
CALGARY, AB, T2J 3J1

March 7, 2022

Vale

200 Bay St, Royal Bank Plaza, South Tower  
Toronto, Ont M5J 2K2

Attention: Renee Barrette, Project Consultant

**RE: 2022 Precipitate Management Scope of Work – REV02**

---

Dear Renee,

Thank you for your interest in SECURE and for the opportunity to provide a scope of work to Vale for the 2022 Copper Precipitate Management project. Throughout the proposal and appendices, SECURE will reference the equipment, experience, project team competencies, safety, and the significant value in SECURE's service offering.

SECURE successfully completed the precipitate removal, processing, recovery and decommissioning of Vale's copper pond #4 in 2021. The SECURE team focused on maintaining a high level of safety and communication with Vale throughout the project. SECURE gained valuable knowledge of the copper precipitate material and the expectations from Vale, Secure has utilized this knowledge in the development of the 2022 precipitate management scope of work.

SECURE relies on our experienced team and integrated service offerings to continually improve our ability to exceed our client's needs and expectations. We believe our ability to refine and expand our portfolio of services diversifies our capabilities across many industries – which benefits our clients through a comprehensive project package. Working with SECURE offers a trustworthy partnership with years of successful industry experience and a commitment to sustainability and the environment. Vale can rely on SECURE to use effective processes and policies to support the safe management of any project, regardless of size, to reach the shared goal of safe and cost-effective solutions.

Sincerely,

**Bryn Olafson, B. Env.Sc.**

Project Manager  
bolafson@secure-energy.com  
C: (204) 641-5491

**SECURE Winnipeg**

999 Redonda St  
Springfield, MB, R5R 0E7

[www.secure-energy.com](http://www.secure-energy.com)

Proposals Development: [proposals@secure-energy.com](mailto:proposals@secure-energy.com)

**TABLE OF CONTENTS**

1.0 SECURE .....2

    1.1 Overview .....2

    1.2 Safety .....3

        1.2.1 COVID-19 .....3

        1.2.2 Safety Documentation .....4

        1.2.3 Subcontractor Management Program .....4

    1.3 Indigenous Relations .....5

    1.4 Sustainability and Community Investment .....6

2.0 EXPERIENCE .....7

    2.1 Project Personnel .....7

    2.2 Competency .....8

    2.3 Equipment .....8

    2.4 Expertise .....8

        2.4.1 Demolition and Decommissioning .....8

        2.4.2 Remediation and Reclamation .....9

        2.4.3 Area Based Closures and Abandonments .....9

        2.4.4 Pipeline Integrity and Watercourse Crossing Rehabilitation .....9

        2.4.5 Metals Recycling .....9

        2.4.6 Waste Services .....9

        2.4.7 Sulphur Services .....10

3.0 PROJECT INFORMATION .....11

    3.1 Introduction .....11

    3.2 Project Scope .....11

    3.3 Budgetary Costs .....11

    3.4 Project Schedule .....11

    3.5 Project Execution Methodology .....12

    3.6 Assumptions and Clarifications .....20

4.0 CLOSE .....21

Appendix A – Project Schedule .....22

Appendix B – Filtrate Treatment System .....23

Appendix C – VALE HS&E Reference Material .....24

Appendix D – Organizational Chart .....25

TABLE OF Appendices

- APPENDIX A – Project Schedule
- APPENDIX B – Filtrate Treatment System
- APPENDIX C – Vale HS&E Reference Material
- APPENDIX D – Organizational Chart

## 1.0 SECURE

### 1.1 Overview

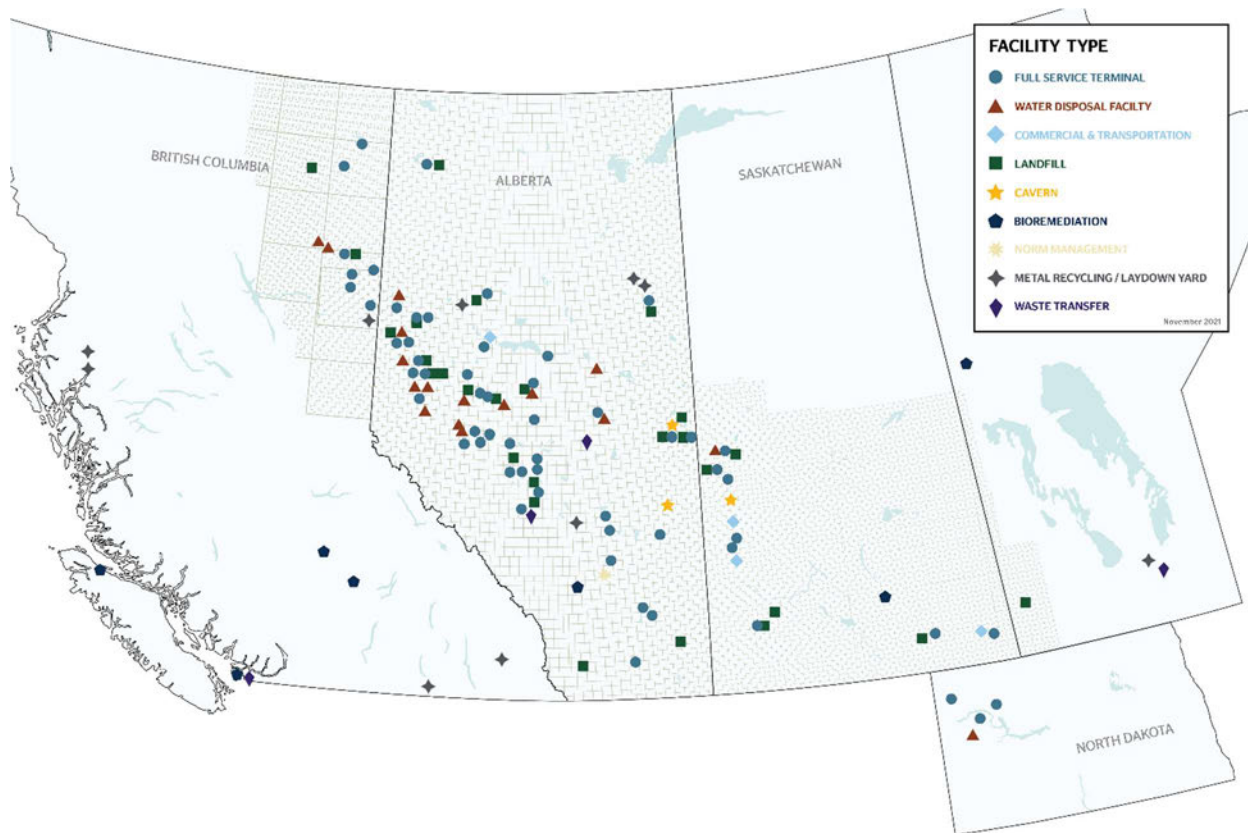

SECURE is committed to tailoring a unique plan for each of our client’s individual operational goals. SECURE acknowledges our client’s commitments to ESG policies and we bring the same principles - sustainability, environment, community investment, and respect for diversity - to each project. SECURE believes that through transparent and open communication we meet our client’s budgetary and time requirements with innovation and efficiency. Partnering with SECURE offers solutions in three divisions: Midstream Infrastructure, Drilling & Production Services and Environmental Services.

SECURE is committed to completing projects safely, and efficiently to create lasting working relationships with our clients. SECURE provides equipment contracting services that support the energy, mining, pipeline, rail, forestry, civil industries across Canada.

## 1.2 Safety

### *Everyone Goes Home Safe*

Safety is paramount to every decision we make as an organization. The SECURE Life Saving Rules ensure that all employees, contractors, and partners “Go Home Safe”. They are designed to assist in promoting proactive behaviour and eliminate the potential for significant safety incidents associated with the most frequent high-risk work activities. All employees, contractors and partners are accountable to follow the Life Saving Rules and are empowered to refuse and stop work where they are not being followed. Safety is foundational to our business and the SECURE Life Saving Rules is a comprehensive approach to achieving zero incidents.



We are committed to continuous improvement efforts that lead to the betterment of our safety culture. SECURE believes that safe work practices create sustainable, reliable, and trusting relationships with our clients and stakeholders.

#### 1.2.1 COVID-19



The health and safety of our employees, our clients or anyone impacted by our business activities is top priority. SECURE has worked diligently to prepare for the known impacts of an infectious disease outbreak which includes the COVID-19 pandemic. Our team adheres to Provincial guidelines of ensuring that masks are worn in shared spaces and when physical distancing cannot be maintained, enhanced cleaning protocols, and supporting employees and contractors if they are required to self-isolate. SECURE has mitigated risk and ensured the safety of both our corporate and field employees and contractors, and successfully completed numerous projects during the pandemic.

SECURE has developed a disease containment plan for the specific needs of SECURE and appoints the HSE Manager as owner of this plan. As required, each workplace has identified a pandemic coordinator who will be responsible for dealing with issues and their impact at the various specific workplaces. This may include contacting local health department and health care providers in advance and developing and implementing protocols for response to ill individuals. SECURE is committed to being transparent with employees and contractors by providing COVID-19 updates and continually adapting our COVID-19 Response Guidelines.

The following responsibilities, preparedness activities and response activities are integrated with the following plans and processes:

- Emergency Response
- Corporate Pandemic
- Enterprise Crisis Management

### 1.2.2 Safety Documentation



SECURE commits to continuous improvement to demonstrate HSEMS excellence that avoids or mitigates adverse health, safety and environmental impacts. SECURE uses the ITRAK platform to track property damage, injuries, or non-compliance events. SECURE centralizes its corrective action log to ensure that all incidents are properly investigated with sustainable corrective actions and assigned responsibilities – this provides the accountability to learn from each event.

SECURE Innovative technologies:

- Internet based delivery of training and certificate tracking through ITRAK.
- All procedures, forms, and competency verification material also available electronically.
- All fleet vehicles are equipped with in-vehicle monitor systems.
- Pro-heat remote starters are used for mobile equipment in cold operating temperatures ensuring when crew member arrive for work the equipment is warmed up and ready to go.
- The SECURE team has developed leading SOPs and JSAs that maximize SECURE and clientele assets by offering safe and effective project and waste solutions for our clients.



### 1.2.3 Subcontractor Management Program

All subcontractors performing work for SECURE undergo a prequalification screening process prior to conducting work. Management of vendor status through ComplyWorks pertain to topics such as: ISO protocols, environmental sustainability, and cultural compliance. Each subcontractor is assessed for acceptability on safety program, safety training matrix, financial stability, and safety performance.

Subcontractors of SECURE are expected to adhere to the SECURE HSEMS, Employee and Contractor Orientation, Drug and Alcohol Policy, client policies and/or OH & S regulations, whichever is more stringent. Subcontractors of SECURE are expected to be competent in assessing work site hazards and follow all safety policies and procedures.

### 1.3 Indigenous Relations

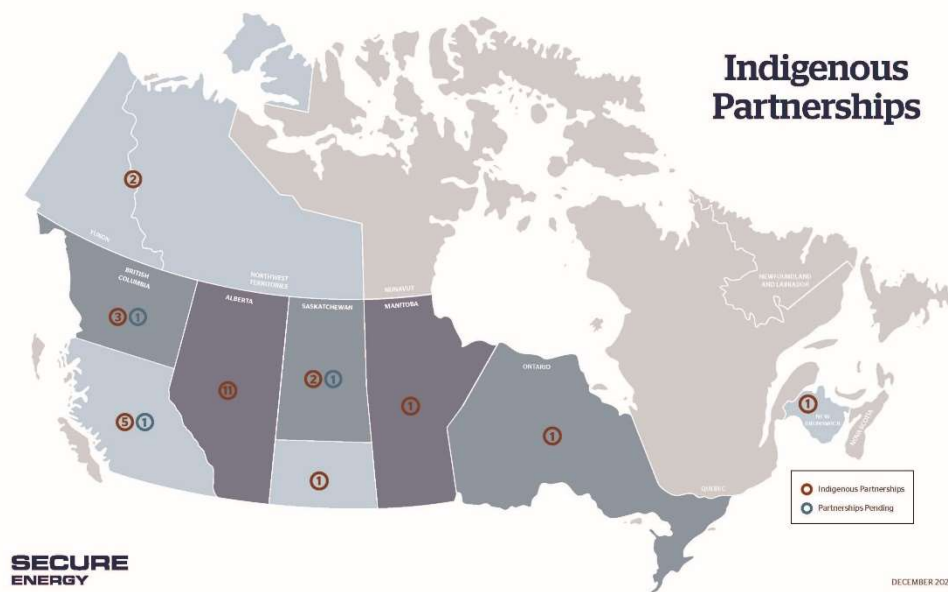

#### Engaging with Indigenous communities where we operate

SECURE believes that through inclusivity we develop sustainable employment and a culture that celebrates diversity. SECURE acknowledges the rights and interests of Indigenous communities, and we understand the importance of using local and Indigenous businesses when possible. We believe Indigenous groups support building and strengthening of effective business relationships, personal development and shared prosperity between Indigenous communities and industry. These responsibilities are shared between SECURE's employees, and vendors and demonstrates our commitment to be respectful and responsible corporate neighbours. SECURE has developed strong relationships with Indigenous groups across Canada; our numerous partnerships and working relationships demonstrate our commitment to our Indigenous allyship. As part of our commitment to this value, we are a proud member of the Canadian Council for Aboriginal Business and the Circle for Aboriginal Relations.



In the Northern Alberta Region, SECURE has a joint venture (JV) agreement with the local Fort McKay First Nation community to provide transportation services, vacuum services, water supply and water treatment, waste management services as well related equipment and staffing resources. SECURE also currently has partnership agreements, JV's, and working relationships with 23 Indigenous communities and respective businesses, providing equipment and crews to programs surrounding the communities and planning for future programming with the industry.

SECURE also has a partnership with the BC Oil and Gas Commission to provide Indigenous communities in BC with training opportunities through a program to receive a Land Reclamation Certificate. In 2018, 19 students received this certificate and in 2019, 15 students completed the program. The land reclamation certificate teaches participants how to reclaim land as a result of development.

### SECURE Vendor Overview

	2020	2019	2018
Indigenous Vendor Utilized	78	51	36
Indigenous Vendor Spend	\$12.3 Million	\$6.7 Million	\$4.5 Million

### 1.4 Sustainability and Community Investment

SECURE’s second sustainability report was published externally in February 2021. In this report, SECURE acknowledges our recent environmental and social achievements along with our long-term goals of creating a more sustainable industry. In 2020, SECURE excavated over 163,000 tonnes of contaminated soil for safe disposal in industrial landfills, and reclaimed over 150 hectares of land, the size of



approximately 340 football fields. We also began structuring a road map for achieving the long-term emissions targets established in our Climate policy last year, including reducing our carbon intensity in half by 2030, and achieving net zero emissions by 2050. SECURE implemented an environmental performance improvement initiative to reduce our power requirements, energy usage and emissions.

SECURE believes in investing in our communities through our time and charitable donations. Giving back to the communities that we live and operate in is imperative to our company values. Highlights from the year include:

- Formalizing a \$100,000 multi-year partnership with STARS Air Ambulance to further enhance our safety culture and commitment to communities where we work. This investment impacts roughly 97% of our employee base and their families;
- Supporting our long-time partners at the United Way of Calgary & Area by running a virtual campaign that raised over \$80,000. In total, SECURE has raised over \$1.3 million for the United Way since the start of our partnership; and
- Collaborating with industry partners and local small businesses to run a campaign encouraging the general public to support local restaurants, raising \$40,000 for The Alex Community Health Centre, The Calgary Foodbank and KidSport Calgary.



So **ALL** Kids Can Play!

SECURE implemented an environmental performance improvement initiative to reduce our power requirements, energy usage and emissions. A copy of the 2020 sustainability report can be found on our website at the following location: <https://f.hubspotusercontent10.net/hubfs/6144363/Sustainability%20Reports/se-sustainability-report-2020.pdf>



## 2.0 EXPERIENCE

### 2.1 Project Personnel

SECURE's leadership team has over 15 years of experience working in collaboration together and collectively they bring an understanding of leading industry practices and well over 35 years of industry knowledge to each project. SECURE recognizes the need for complete and accurate cost control for all stakeholders involved within each project. A Project Manager (PM) who has experience with the execution of similar types of projects is assigned to the project and will oversee the execution of the entire project, attend all stakeholder meetings, and provide all necessary reporting. SECURE provides a supervisor who is competent and adequately trained and complies with SECURE HSEMS and client specific requirements. In addition, the project as required will employ SECURE's trained and competent work force including operators, labourers, and safety and technical representatives.

Secure proposes to utilize the following dedicated personnel to complete the bagging and extraction activities:

- Project Manager (1)
- Construction Safety Officer (1 per shift)
- Site Supervisor (1 per shift)
- Project Coordinator (2)
- Operators, including hook truck driver (8)
- Labourers (8)

SECURE is anticipating to allocate twenty (20) crew members to Vale for the entire 2022 construction season. Furthermore, Secure is aware that additional project personnel will be required to complete the supplemental scope requirements, such as filtrate treatment operations, geotechnical assessments, including engineering required therein. If required, sub-contractors will be considered to complete specific scope of work tasks.

SECURE will supply two dedicated project managers (precipitate management and filtrate removal) who will be responsible for all Vale quality control and quality assurance reporting requirements. Both project managers will be supported by their respective regional managers for both direct and indirect assistance.

At Secure, every employee is responsible for the safety of themselves as well as other coworkers, subcontractors, and visitors. During the daily tailgate meeting it is announced who the designated and alternate Safety Representative and First Aider are for that day. Also discussed during the meeting is safety information, safety personnel and procedures, planned work tasks, and subcontractor information. The people who have been elected for designated Safety Representatives or designated First Aiders are most often rotated through the positions on a weekly basis. This is to ensure there are fresh observations regarding site safety and active discussions throughout all crew members. People elected for the position of Designated Safety Representative and Designated First-Aid are longer term Secure employees who act as an employee ambassador and promote peer to peer discussions.

Secure projects receive site visits from Secure Regional Safety Advisors and Managers monthly. Safety Advisors and Managers visit Secure sites to provide general safety suggestions, perform one-on-one discussions, interviews with crew, and perform Site Safety Audits. This visit completes an Active and Meaningful Site Visit which is a new documented program that is being introduced by Secure. Site Safety Audits are completed on as per regulation requirement or as requested by the project team.

## 2.2 Competency

SECURE provides project teams that are highly experienced, qualified, and trained for the execution of client projects. All employees are trained on the tasks they perform on a regular basis and are not to attempt tasks they are not adequately trained for. Prior to being able to perform their job without direct supervision, an experienced mentor verifies that the employee is competent to perform their roles and responsibilities before independent work. SECURE is a publicly traded company with an excellent reputation of financial security and a highly regarded and reputable safety program, stability, and consistent procedures. This has resulted in the retention of quality employees, cohesive training procedures, and leading safety programs to aid in the completion of your project.

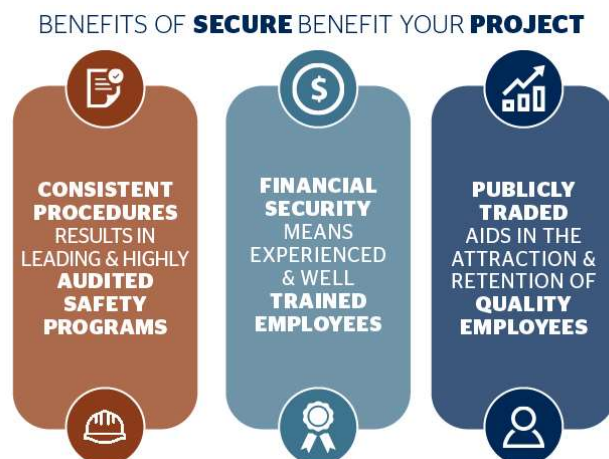

SECURE will provide a copy of our Employee Competency Program upon request.

## 2.3 Equipment



SECURE owns a diverse fleet of over 150 pieces of heavy equipment that includes excavators, shears, dozers, loaders, 30- and 40-ton rock trucks, and other specialized equipment such as sandblast equipment, diversion pumps, centrifuges, and work tools. SECURE provides services using SECURE owned equipment, facilities and staffing resources which results in realized cost savings. SECURE is focused on preventative maintenance and providing equipment to client projects that is new, regularly conditioned, inspected, and in excellent working condition. SECURE understands that reliable equipment, tools, and vehicles are critical to the success and safety of every project, this means a commitment to keep all tools, equipment, machines, and vehicles in a safe and reliable condition, limiting downtime and extending productivity.

SECURE provides the specialized equipment necessary for projects to be completed safely by experienced operations. Our wide range of equipment allows us to complete projects in varying regions from remote areas to urban centers.

## 2.4 Expertise

### 2.4.1 Demolition and Decommissioning

SECURE's bench strength in facility demolition, decommissioning, asset salvage recovery, and owning a fleet of specialized demolition equipment has provided us with a strong reputation as a leading, competent demolition contractor. SECURE has successfully completed engineered dismantlement and demolition of gas plants, compressor stations, oil batteries, and pipeline facilities and downstream gas stations and industrial facilities across Western Canada, and Ontario. SECURE has extensive experience with facility projects, numerous multi-story buildings in urban centers and oil sands facility decommissioning and demolition in remote locations as well as winter only access sites.

Annually, SECURE processes and sells hundreds of thousands of tonnes of ferrous and non-ferrous metals to the international market. Our goal on every decommissioning and demolition project is to lower costs by maximizing asset salvage which includes selling scrap metal that provides cost benefits back to our clients.

#### 2.4.2 Remediation and Reclamation

The SECURE Projects team helps our clients with removal of contaminants from soil, groundwater and sediment, and reclamation for the protection and betterment of the public and environment. SECURE also has the capability of managing remedial aspects of pond projects, from sludge removal and remediation to re-shaping and re-lining of ponds with best practices and cost-effective technologies. Our ability to integrate SECURE solutions produces cost savings for our clients, including mobilization, equipment and lead time and administrative costs.



#### 2.4.3 Area Based Closures and Abandonments

SECURE's team of abandonment professionals are highly recognized as experts in complex and remote access or winter only access abandonment projects. SECURE provides all innovative equipment requirements for cut and caps, surface asset removal with our field operations. SECURE's compliance offering includes pre-abandonment field inspections, surface casing vent flow and gas migration testing, source identification through carbon isotope gas sampling, ground water protection, and porous zone isolation. In addition to our field operations, SECURE offers compliance requirements of regulatory applications, waivers, and reporting.

#### 2.4.4 Pipeline Integrity and Watercourse Crossing Rehabilitation



Our integrity excavation services assist clients to safely provide visual inspection abilities to repair anomalies on pipelines. SECURE offers a complete integrated integrity excavation service including locating, excavating, hand exposing, coating removal, sandblasting, recoating and backfill. SECURE is experienced in various repair and replacement services including cut-outs, sleeve installation, sleeve repairs, and pipeline lowering. This all-encompassing offering ensures our client's assets are fulfilling their delivery obligations, operating efficiently, and mitigating the risks associated with incidents affecting the public, the environment and the

client's reputation. We understand the potential risks with these tasks and have procedures to minimize the risk to employee safety and the environment.

SECURE is able to provide further service overviews, project case studies and client references upon request.

#### 2.4.5 Metals Recycling

SECURE has a large fleet of mobile scrap processing equipment including mobile hydraulic shears, picker trucks, balers, loaders, as well as excavators and purpose-built material handlers fitted with magnets and grapples. We haul scrap metal with our fleet of flat decks, Super B-Train scrap hauling trailers and end dumps. Our fleet of rail cars enables us to access markets across North America. We conduct onsite bone yard clean-ups, oilfield and mining demolition services throughout British Columbia, Alberta, and Saskatchewan. Onsite scrap metal recycling services are supported from our full-time scrap receiving and processing facilities located in Kimberley, Trail, Peace River, Fort McMurray, and our main facility in Red Deer. For inquiries, please email [metalsales@secure-energy.com](mailto:metalsales@secure-energy.com) and our Metals Recycling Group will get in touch with you.



#### 2.4.6 Waste Services

SECURE provides comprehensive professional waste management services including characterization, profiling, manifesting, transportation, recycling, and disposal of hazardous and non-hazardous waste.

With a multitude of disposal/treatment options available, SECURE handles a wide range of industrial and commercial wastes. Through volume agreements and consolidation, SECURE will manage waste efficiently and cost effectively in accordance with all applicable regulations.

SECURE's Waste Management group consists of a team of experienced Field Technicians, Superintendents, Operations and Equipment Coordinators and Project Managers—all dedicated to finding the solutions our clients are seeking for their waste management issues. Most wastes may require a waste technician to visit the site to complete an inventory prior to waste pick-ups. The diverse knowledge and expertise in many waste streams of our team can significantly improve the efficiency of a project and lower the cost to the customer. SECURE's technical services include:

- Analytical Review for Waste Characterization and Profiling
- Approval Management & Industrial Regulatory Compliance
- Sustainability Reports, supported by waste tracking reports and annual waste diversions summaries
- Liability & Risk Management
- Emergency Response and Clean-up (1-800-32-SPILL)
- Management of NORM contaminated materials

#### **2.4.7 Sulphur Services**

SECURE has provided Sulphur block pouring, excavation, and remelt operations for numerous oil and gas producers throughout Alberta with over 20 years of collective experience. Current projects include operating a Sulphur blocking facility at a large oilsands facility in Fort McMurray since 2008.

Our specialized services include:

- Sulphur pouring
- Sulphur block excavation
- Sulphur re-melting
- Contaminated Sulphur reclamation and filtering
- Transportation and logistics
- Sulphur disposal and re-use options
- Acid water services
- Remediation and of Sulphur Impacts
- Environmental monitoring, permitting, and reporting

The SECURE advantage:

- 20 years Sulphur-specific experience
- More than 2,000,000 million tonnes remelted and nearly 1,000,000 tonnes poured
- Emergency response services
- Full suite of services to provide solutions for all your Sulphur needs

## 3.0 PROJECT INFORMATION

### 3.1 Introduction

Vale has requested the services of SECURE to perform the role of Engineering, Construction and Management (ECM), acting as Prime Contractor to complete the 2022 Precipitate Management scope of works.

It is understood that Vale Thompson has reached filtrate capacity in copper ponds #5 and #6 and requires assistance to treat and appropriately discharge wastewater to the Tailings Management Area. Additionally, Vale Thompson would like to extract, process and prepare precipitate material for transport in order to assist Vale as they finalize the sale of precipitate to the open market.

### 3.2 Project Scope

Vale has requested the services of SECURE to perform the role of ECM for the required processes for the 2022 precipitate management scope of work. The main objectives are the following:

- Geotechnical assessment of pond #5 and #6 and required improvements.
- Filtrate treatment and discharge from pond #6.
- Filter press and bagging of the sludge from pond #6.
- Sampling of precipitate from stockpile #3 and ponds #5/#6.
- Relocation of exploration cores.
- Improve space constraints with the addition of a new containment pad or through the supply and erection of a building coverall structure.
- Infrastructure improvements to roadways. Geotechnical assessment may be required depending on engineer's recommendations and requirements.
- Bagging 7,000 tonnes of intermediate product from pond #4, currently stockpile on the containment pad.
- Extraction and processing of 12,000 tonnes of copper precipitate from pond #6.
- Bagging 6,000 tonnes of intermediate product from pond #6 and stockpiling the additional 6,000 tonnes, during the 2022 work season.
- Potential bagging of pond #3 material (budget not included in Vale\_2022 Budgetary Projections 2022feb16).

### 3.3 Budgetary Costs

Based on the revised scope of work detailed within this document, SECURE has submitted the 2022 water treatment and precipitate management budgetary projections to Vale on March 3, 2022.

### 3.4 Project Schedule

Secure crew members will work 12 hours per day, 7 AM to 7 PM from Monday to Sunday, maintaining a schedule of 21 days onsite and 7 days offsite.

The exception to this schedule is planned during the bagging activities of the 7,000 tonnes of intermediate product from pond #4, a 12-hour day shift and 12-hours night shift will be present onsite. The crew will continue the 21-day onsite and 7 days offsite rotation.

Prior to freshet activities are expected to include:

- The geotechnical assessment of pond #5 and #6
- Mobilization and setup of the pond filtrate treatment system. The goal of the early mobilization is to ensure the system is fully functional once the filtrate has thawed.
- Confirm space availability for placement of processed bags awaiting transport.

Spring activities are expected to include:

- Operation of the filtrate treatment system within pond #6. Operation may extend until freezing conditions occur.
- Potential removal of core samples from the thaw shed, mapping, and placement at the core farm.
- Preparation of laydown areas and mobilization of supplies required for bagging activities.
- Potential preparation and construction of the additional concrete containment pad or extension of the current containment pad.
- Safety barriers as required on the roadway that extends between pond #5/#6 and the precipitate management area.
- Sampling of the copper precipitate from pond #5 & #6 and the material within stockpile #3. Providing Vale with grade determination as early as possible within the year will allow for effective intermediate product management planning.
- Bagging of stockpile #4 intermediate product
- Temporary relocation of bagged intermediate product within the established lay down area and/or loading bags for transport to Sudbury operations.
- Improvements to pond #5/#6 structures as recommended by the geotechnical engineer.

Summer/Fall activities are expected to include:

- Extraction and transport of 12,000 wet tonnes of copper precipitate from pond #6 to the precipitate management area. Extraction is anticipated to begin mid-July 2022.
- Processing of the copper precipitate with hydrated lime
- Stockpiling 6,000 tonnes of intermediate product extracted from pond #6
- Bagging 6,000 tonnes of intermediate product extracted from pond #6 during the 2022 year.
  - M3 are currently the primary planned means of containment for the intermediate product, if the decision is made to contain the product in an alternative means the SOW and schedule will be modified.
- Site close out for the winter months, including the placement of liners over stockpiles, storage, and protection of materials to be utilized in subsequent years.
- Demobilization of labour and equipment.

Fall/Winter activities are expected to include:

- Project planning for the 2023 season

The project completion and anticipated schedule will be reviewed daily by management and the onsite supervisor with the project team including Vale to ensure efficiency, logistics and safety are as agreed upon.

Please see **Appendix A** for Project Schedule. Estimated milestones have been included in the project schedule, the dates will be reviewed and revised throughout the project planning stages, the updated schedule will be continually shared with the Vale team. The schedule may be subject to change based on drying efforts, weather conditions and unforeseen delays to the project.

### **3.5 Project Execution Methodology**

SECURE'S project methodology has been developed to successfully complete the tasks set out by Vale a sustainable manner. We have assumed that the contract scope of work will be finalized during discussions.

#### **Project Planning and Reporting**

SECURE will work closely with the Vale team to ensure all aspects of the 2022 scope of work will be effectively executed. Regular meetings between the Vale and SECURE stakeholders will be performed to review budget, schedule, HS&E and planned tasks. Reporting and meeting expectations are as follows:

- Daily meeting with project team
- Daily update report emailed daily in pdf format
- Weekly meeting with project team. Action list and minutes emailed in excel format
- Risk Register maintained and shared with project team as required
- Weekly finance update emailed in excel format
- Monthly KPI report in power point format with excel backup emailed on the 2<sup>nd</sup> Thursday of each month, includes:
  - HS&E update
  - Finance actuals
  - Budget forecast monthly & year to date with variance analysis
  - Performance & work KPI summary (ie. \$/ton cost of precipitate extraction) KPI expectations TBD
- Project Schedule updated weekly in gantt or excel format
- Final project report at the end of the 2022 work season

### **Procurement**

Procurement of several project critical materials will begin as early as possible to ensure the products are sourced at the most competitive prices and are readily available as needed. All materials required to successfully fulfill the scope of work requirements will be procured. These items include, but are not limited to:

- Filtrate treatment chemicals
- Hydrated Lime
- M3 bags, pallets, and product packaging
- 6 mil Geotextile
- Core Trays
- Core rack timbers

### **Health, Safety & Environment**

SECURE'S HS&E team will develop and implement a rigorous safety plan during the project planning stage. In accordance with SECURE'S OH&S program, Vale's Health and Safety Policies and CARS, SECURE will prepare and present a Site-Specific Health & Safety Plan (SSHSP) that will include but not limited to the following:

The hazards identified at this worksite are as follows:

- Material and hazardous material handling, storage, and packaging
  - Copper precipitate
  - Intermediate Product
  - Filtrate from ponds
  - Filtrate treatment chemicals
  - Hydrated Lime
- Work area access
  - Third party
  - Individuals not contracted by SECURE in work area
  - Wildlife
  - Nuisance
- Continual Operations, including day/night shift site personnel
- Heavy Equipment operation and fueling
- Heavy equipment requiring comprehensive training
- Mobile equipment

- Overhead and underground utilities and client infrastructure
- Work in congested areas/close to critical client processed
- Spills or releases
- Acute, adverse temperatures
- Extreme weather – storms, wind/wind gusts, precipitation, and dust
- Working in proximity to other subcontractors

The risks associated with the hazards listed above include the following:

- Negative health affect to worker(s)
  - Injury
  - Exposure – hazardous material, corrosive substances, noise
- Damage to equipment (heavy and light duty)
- Damage to Vale unfractured
- Damage to reputation

The SSHSP will de developed as part of the overall application of the on-site safety program for the required operations that are to be performed by site personnel. All applications of the safety program will be in accordance with Provincial regulation and SECURE’S OH&S manual, a copy of each document will always be located at the site office. The SSHSP will detail the appropriate requirements to safely perform the necessary work that is to be carried out, including Vale’s requirements to follow SPI’s, Policies and CARS. As the project progresses and site conditions change, modifications to the SSHSP may be required.

Prior to mobilization SECURE will complete a PHR review of the planned tasks. The potential project risks will be identified and mitigated. The PHR document will be reviewed with the Vale and SECURE management teams, and once again with the field staff during the project kickoff.

SECURE will complete CTRF forms for all site personnel and provide the required support documentation to Vale prior to arrival.

Minimum approved personal protective equipment (PPE) will be required by all site personnel and visitors regardless of the type of work being conducted at any time. The requirement for specialized safety equipment will be assessed by SECURE’S safety department prior to work commencement and at the re-evaluation stages. Minimum PPE to be worn by all authorized personnel at designated work sites (excluding designated exclusion zones) will include:

- Chemical resistant Tyvek and gloves with full face respirator while working near precipitate, intermediate product, filtrate, and hydrated lime
- Canadian Standards Association (CSA) approved safety glasses
- CSA approved protective work boots, with metatarsal protection
- CSA – Class B (side impact) hard hat
- Coveralls with reflective stripping or five-panel tear-away high visibility safety vest. SECURE to accommodate Vale’s requests for coverall colors.
- Leather work gloves or other approved hand wear—available on person

SECURE will comply with the COVID-19 protocols implemented by the Province of Manitoba and Vale, including testing prior to mobilization and follow-up testing upon arrival.

SECURE personnel will comply at all times with the items listed within **Appendix C** – Vale HS&E Reference Material



## **Kickoff Meeting**

A successful project is a project that was delivered which met all goals, expectations, and requirements of the initiating party. This statement is very much accepted on the international project management stage. Furthermore, the delivery of a successful project is directly dependent on how well the execution of the project was planned and how well information was shared within the project team.

The purpose of the kickoff meeting is to confirm the stakeholders in the project, identify communication requirements, share information on processes and procedures for safety and security requirements, and request information required for execution of the works and establishes high level interface protocols.

An initial site safety kick-off meeting will be held with the onsite team, all safety protocol and procures will be reviewed during this meeting. Emergency gear, muster points, works site delineation and evacuation routes will be shared with the site personnel.

The site kick-off meeting will cover:

- Secure project team organization
- Vale project team organization
- Scope of work
- Metrics to be used to measure success
- Roles and responsibilities
- Schedule and milestones
- Identified high level risk
- Health, safety, and the environment
- Quality control
- Reporting

## **Mobilization and Work Site Setup**

SECURE will mobilize the crews and equipment in several stages as they are required onsite. All mobile equipment will be clean and in good working condition upon arrival to site.

Initial mobilization will include the labour and equipment required for the site preparation and installation of the filtrate treatment system, geotechnical engineer and preparation crew and equipment for the core farm expansion.

The second mobilization will include the operator(s) for the filtrate treatment system, crew, and equipment to map and remove cores from the thaw shed, preparation and construction crew for the laydown areas and containment pad and roadworks teams.

The third mobilization will include the labour, equipment, and materials to bag the stockpile #4 intermediate product and the sampling team.

The fourth and final mobilization will include the labour and equipment for the copper precipitate extraction and processing from pond #6.

The proposed site amenities for this project will consist of a site office trailer, lunchroom trailer, washroom trailer, decontamination unit, a tool crib, fuel tanks, light towers, and generators. Designated parking and smoking areas will be identified near to the work site. The facilities will all be located within proximity to each other for the safety, security, and power requirements.

The 2 main work areas are as follows:

### Processing Area

The processing area includes a concrete sump pad, tent structure and thaw shed. The site amenities previously detailed will be staged in this work area. The area will be used process the precipitate from pond #6, bag intermediate product, stockpile, and load for shipment.

### Pond 5 & 6 Area

The area surrounding pond #5 & #6 will be utilized as a staging area for the filtrate treatment system. Heavy equipment will also operate in the area for the precipitate removal process.



### Delineation of Work Areas

During the site setup activities SECURE plans to identify and delineate the work zones that the crew members will be utilizing. The team will be ensuring that individuals at the Vale site are able to easily identify and avoid entering the SECURE work zones. The zones will be delineated utilizing reflective metal signage, wooden barricades, caution tape, cones, and physical barricades. The work zones are expected to change and evolve throughout the year and will require continual assessment and modification. SECURE also expects that the travel zone between the ponds and processing area will pass under overhead lines. The lines will be identified utilizing a goal post type system. Work zones and overhead lines will be identified to all personnel during their work site orientation.

Boards and signage for area – reflective metal signs

### Filtrate Treatment and Removal System

Filtrate treatment and removal SOW from Ponds #6 are detailed in **Appendix B**.

### Sampling of Pond 3, 5 & 6 material

Sampling of stockpile #3, pond #5 and pond #6 material will be performed as early as possible upon mobilization. The samples will be analyzed to determine the grade of the product, specifically focusing on metal contents of Cu,

Ni, As and PGM's. Sampling will be performed by the SECURE site personnel and analysis will be performed by Vale. Sampling may also provide knowledge of the density of the material contained within the pond and the depth of the material.

Sampling of ponds #5 and #6 will follow the information detailed in the document titled "Pond Samples SOW REV02" as provided by Vale. Sampling of stockpile #3 will be performed utilizing an excavator to collect the sample from several locations throughout the stockpile. The sample will be packaged appropriately and sent for analysis by Vale.

#### **Geotechnical Assessment (as per Memo SOW Geotechnical)**

The geotechnical integrity of the pond #5 & #6 structure is currently unknown. In order to ensure the integrity of the structure can be maintained throughout the next 3-5 years, a geotechnical assessment must be completed to determine the following:

- Assurance that both ponds will continue to securely contain filtrate and precipitate materials as work progresses
- Continue to contain precipitate and filtrate during precipitation events
- Gain an understanding of infiltration as it pertains to pond stability
- Withstand and provide safe passage as heavy equipment and transport vehicles work on the crest of slopes of the pond during extraction activities.

Based on the geotechnical assessment study completed, a geotechnical engineering firm will present their findings and if additional upgrades are required, an engineered scope of work will be produced, complete with a detailed scope of work and necessary technical drawings.

SECURE will facilitate the necessary construction and repairs, as directed by Vale and the structural engineer. The engineer will continue to monitor the integrity of the pond structure and report all required information to the project team.

#### **Road Works**

Significant portions of the roadway extending between ponds #5/#6 and the material processing area is currently restricted to one-way traffic and requires improvements to the shoulders to ensure compliance with CARS03.

Widening of the roadway has been considered to ensure the safety of all vehicles travelling on the roadway. The width of the roadway may be expanded to accommodate two-way traffic, this would include the import and placement of aggregate adjacent to the one-way road.

It is understood that Vale has procured bollards with intention of placement along both shoulders of the one-way road. Secure will facilitate the placement of the bollards.

All road works are dependent on the following:

- Vale approval for engineering study and work
- Engineering scope, budget cost, schedule and drawings of work proposed
- Vale approval of the work, including budget approval
- Construction/Management and execution of work (including QA/QC)

#### **Management of Cores (as per Memo SOW Core Shed)**

The thaw shed and core tent contain 52,000 and 7,680 core boxes, respectively. The majority of the cores require movement from their current location to the core farm and an undetermined amount of ultramafic cores must be moved to the core tent from the thaw shed.

Prior to movement of the cores, earthworks at the core farm must be completed, including clearing, grubbing and grading of a 7,000m<sup>2</sup> area. Installation of geotextile, 18" of 6" minus and 6" granular A aggregate will follow. Once the area has been prepared 60 outdoor core racks will require construction from 78 4" x 4" X16" rough timbers.

The core boxes will be inspected prior to movement, if it is found that the core boxes are damaged the cores will be moved to new core boxes. It is anticipated that 4,000 AQ size, 6,000 NQ size and 6,000 BQ boxes will be required. Aluminum tags will be prepared for the cores that are moved from their original boxes to new boxes. Special care will be taken to ensure that the cores are transferred in the identical sequence that that they are found.

A scissor lift will be utilized to access the cores that cannot be safely retrieved from the ground level, personnel utilizing the lift will be trained for work at heights and will don the appropriate fall restraint gear. A loader and skid steer will transport the cores boxes from their current location to a truck equipped with a low bed trailer. The cores will be transported to the core farm or core tent as directed by Vale and placed within the newly constructed core racks. Throughout this process all cores will be catalogued and mapped, this information will be provided to Vale.

SECURE proposes to begin this task as early as possible in 2022. This is due to the expectation that labour resources will be limited to 20 individuals during the extraction and bagging phases of the project. Early 2022 kickoff would prevent the reduction in productivity to the planned tasks because of the requirement to share labour resources later in the season. Ideally the core transfer crew would shift directly to stockpile #4 bagging activities once the core transfer is complete.

#### **Containment Pad Expansion, Tent Extension**

SECURE recognizes that storage space for intermediate product is a noted concern to achieve the current project goals. SECURE will work closely with Vale to determine the most effective method to increase working space, while considering cost, timeline, and safety of the project. In order to achieve the increased workspace the concrete containment pad may be expanded or the containment tent may be extended.

Containment pad expansion and tent extension works are dependent on the following:

- Vale approval for engineering study and work
- Engineering scope, budget cost, schedule and drawings of work proposed
- Vale approval of the work, including budget approval
- Construction/Management and execution of work (including QA/QC)

#### **Bagging of Stockpile #4 Intermediate Product**

Currently 7,000 tonnes of intermediate product is stockpiled and contained within a tarp on the concrete containment pad. It is understood that Vale requires this material to be placed within m3 bags to be transported offsite to the Vale Sudbury operations. To bag the material in the most time efficient method SECURE proposes to utilize a 12-hour day shift and 12-hour night shift focused solely on bagging activities.

Prior to beginning the bagging activities, a work lay down areas will be established in order to accommodate the bagging supplies and filled bags. Current estimates for the 2022 season include 9,600 m3 bags, liners and pallets, these items will require proper storage to ensure they are not damaged prior to usage.

The bagging process is as follows; removal of the tarps that are currently utilized to cover and protect the intermediate product. Excavation of the intermediate product utilizing an excavator and loading into a rock truck to be transported to the tent. Additional hydrated lime will be delivered to site as required. The product will be combined with hydrated lime to neutralize the product sufficiently. The mini ex will load the intermediate product via the hopper into lined m3 bags, placed atop a pallet with a cardboard protection layer. Once filled the m3 bags will be labeled as per the requirements and wrapped with a pallet wrapping system to ensure the protection of the m3 bags and the affixed labelling. The skid steer equipped with forks will transport the m3 bag to the storage location and the bag tracking information will be recorded in the intermediate product tracking list.

The filled m3 bags will be loaded onto highway trucks utilizing a loader equipped with forks. The bags will be transported to Vale Sudbury operations. Transport of bags performed by others.

### **Extraction of Precipitate from Pond #6**

Pond #6 contains approximately 46,000 wet tonnes of precipitate. The precipitate within pond #6 requires removal and processing with hydrated lime. During the 2022 works it is expected that 12,000 wet tonnes of precipitate will be extracted from pond #6.

Prior to extraction the filtrate currently contained within the pond will require treatment and discharge to allow access to the precipitate material.

The precipitate at the south-west corner of pond #6 currently sits above the filtrate level and is expected to be the most readily available material for extraction. Once the precipitate that is easily accessible from the shore has been extracted, pads of material will be constructed into the pond area to provide a stable surface for the excavator to sit atop and access additional precipitate.

SECURE plans to utilize a long reach excavator to extract the precipitate from pond #6 and place into a hook truck equipped with a closed top roll off bin. The closed top bin will contain the material to ensure there is no spillage during transport to the processing tent. Upon arrival at the processing tent the truck will back into position, labourers will clamp poly to the back of the truck to protect the truck from becoming contaminated during the offloading process. The labourers will release the latches of the truck and the precipitate will be dumped into the containment tent. The truck box will be returned to the level position and the latches will be secured. The poly will be removed, and the truck will be cleaned as required with a pressure washer to prevent track out through the site. As a final protective measure, the truck will travel through a “wheel bath” to ensure all precipitate remnants are removed from the truck tires. Labourers will be readily available on both ends of the travel route as traffic control and to assist with the operation of the bin during loading and offloading.

Precipitate material that is found to contain plastic and/or wood may require additional measures to carefully remove the debris.

Within the processing tent the precipitate will be combined with hydrated lime by mechanical means. The precipitate will be activated with the lime until stabilized to create the intermediate product. The intermediate product will be transported to the stockpile on the concrete containment pad or immediately bagged depending on the current requirements.

It is expected that 6,000 tonnes of the intermediate product generated will be placed into stockpile and 6,000 tonnes will be contained within m3 bags and either shipped from site or placed onsite during the 2022 season. The remaining intermediate product will be bagged at the commencement of the 2023 work season.

The initial proposed goal of extracting 10,000 wet tonnes of precipitate from the Copper Ponds throughout 2022 may be exceeded if the projected milestones are achieved and optimal conditions are maintained. SECURE anticipates that the removal of an additional 2,000 wet tonnes, for a total of 12,000 wet tonnes is likely barring unforeseen and unplanned site events.

Secure will supply and deliver hydrated lime to the processing tent as needed. The lime will be delivered by a 40-ton pneumatic B train. The trucks will be offloaded at the designated laydown area through a three-inch pipe attached to the discharge valve. The lime will be blown underneath a containment tarp, which is located within the tent. The tarp will be secured utilizing the outer grommets and will remain over top of the lime material.

The bagging process will follow the same process as detailed in Bagging of Stockpile #4 Intermediate Product methodology. Bagging activities that extend into the winter months are expected to require additional heating and lighting in order to proceed.

Daily samples of the intermediate product will be provided to the Mill laboratory for moisture analysis. Adhoc and weekly samples to be delivered to the Mill lab and the Sudbury Central Lab via 5 gallon pails.

### **Winterization**

Prior to demobilizing from site, special care will be taken to ensure that all materials are left in a manner that will be suitable to endure the winter months. Bagging supplies will be stored out of the elements within the thaw shed or tent. Stockpiled intermediate product and remaining hydrated lime will be covered and secured with tarps. When possible, work areas will be left in a condition that will facilitate the remobilization in the spring of 2023.

### **Demobilization**

Site closeout will take place at the completion of construction activities and will include site clean-up of all items to the satisfaction of Vale. Decontamination of equipment and tools will take place at the end of the project. Demobilization of equipment, personnel and project support infrastructure will take place.

### **Proposed Equipment List**

- CAT 336 Long Reach Excavator with 65' boom
- CAT 325 Excavator
- CAT 320 Excavator
- CAT 950/936 Loader
- CAT 308 Mini Ex
- 30-ton rock truck (2)
- Scissor Lift (2)
- Bobcat 277 Skid Steer
- Truck and Lowbed
- Hook Truck with bin (additional 3 bins)
- ½ ton – ¾ ton pickups (4-5 per shift)
- Trailers; Office, Lunch, Washroom, Decontamination
- Generator (2)
- Light Tower (2)
- Tool Crib
- Fuel Cube (2)
- Hopper (2) – supplied by Vale
- See Appendix B- Pond Water Draw-Down for complete list of Filtrate Treatment Equipment

## **3.6 Assumptions and Clarifications**

1. All work to be completed on a T&M basis.

## 4.0 CLOSE

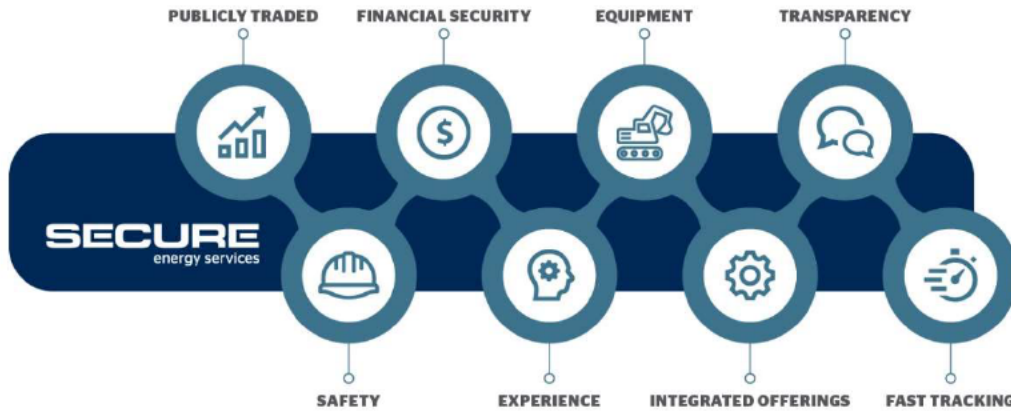

SECURE is committed to safety, quality, and transparency to maintain our reputation as a reliable contractor. SECURE offers communication and expertise through experienced employees, financial security of being a publicly traded company, safety adherence and record, and integrated service offerings that provide efficiencies from commencement to project completion. We look forward to communicating further with Vale and establishing a true sustainable working partnership. Please contact the undersigned at [bolafson@secure-energy.com](mailto:bolafson@secure-energy.com) for any questions or to discuss further.

Best Regards,

Bryn Olafson B.Env.Sc.

Project Manager

## APPENDIX A – PROJECT SCHEDULE



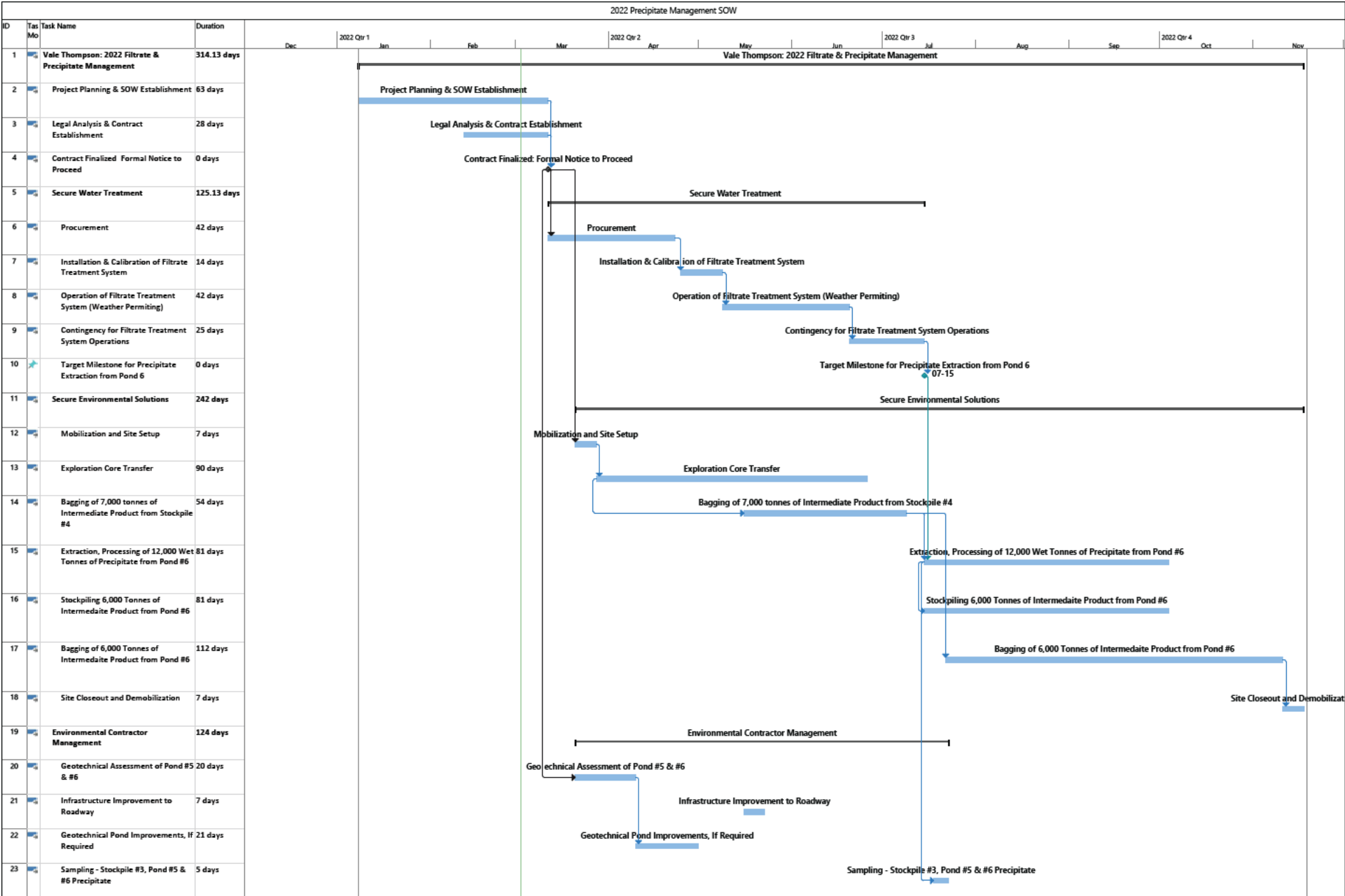

**SECURE ENERGY**

Task	Summary	Inactive Milestone	Duration-only	Start-only	External Milestone	Manual Progress
Split	Project Summary	Inactive Summary	Manual Summary Rollup	Finish-only	Deadline	
Milestone	Inactive Task	Manual Task	Manual Summary	External Tasks	Progress	

## APPENDIX B – FILTRATE TREATMENT SYSTEM

# VALE THOMPSON

## POND WATER DRAW-DOWN WORK PLAN

SUBMITTED BY:  
BASIL GIRGRAH  
March 3, 2022



**SECURE**

13511 VULCAN WAY,  
RICHMOND, BC V6V 1K4

**TABLE OF CONTENTS**

1.0 PROJECT INFORMATION .....1

    1.1 Project Understanding & Scope .....1

    1.2 Proposed Personnel & Equipment .....1

        1.2.1 Personnel .....1

        1.2.2 Equipment .....1

        1.2.3 Sub-Contractors .....2

        1.2.4 Materials & Consumables .....2

        1.2.5 Backup Equipment & Materials .....2

    1.3 Project Execution Plan .....3

        1.3.1 Design Phase & Desk-Top Study .....3

        1.3.2 Mobilization .....3

        1.3.3 Equipment Setup .....3

        1.3.4 Commissioning of the System & Operation .....6

        1.3.5 Confirmation Sampling & Analytical .....8

        1.3.6 Teardown & Decontamination .....9

        1.3.7 Demobilization .....9

    1.4 Site-Specific Safety .....9

        1.4.1 Daily Safety Activities .....10

    1.5 Project Schedule .....10

        1.5.1 Overall Schedule .....10

        1.5.2 Daily Activities .....10

    1.6 Assumptions and Clarifications .....11

**TABLE OF APPENDICES**

- APPENDIX A – SECURE Equipment Profiles: Mobile Mix Tank, Fixed Ring Clarifier & Mobile Filter Press
- APPENDIX B – Process Engineer Statement of Work – Neutralization Project
- APPENDIX C – Process Flow Diagram

## 1.0 PROJECT INFORMATION

SECURE uses a centralized, integrated platform called 4castplus where the jobsite is connected in real-time with project management, project controls, procurement and finance. With intelligent workflows and critical tools, 4castplus project cost management software connects the dots between the many moving parts of complex projects. 4castplus is a centralized, integrated platform where the jobsite is connected in real-time with project management, project controls, procurement and finance – all sharing workflows and data in an integrated collaborative solution. Its powerful suite of project controls software delivers real-time insight into the health of your projects and programs.

### 1.1 Project Understanding & Scope

It is SECURE's understanding that the primary purpose of this project is to draw down the water level in Pond # 6 at Vale Thompson. Secondary purposes include: produce sellable product from the precipitate resulting from the neutralization of pond water; removal of sludge from Pond #6 after the water has been drawn down; and increase the pH of the water in Pond #6

It is SECURE proposal that this project will encompass the following:

- Bench Top Study & System Design
- Mobilization of crew and equipment to site in Thompson MB
- Site Indoctrination
- Equipment setup and commissioning
- Operation of equipment
  - Stage 1: Neutralization
  - Stage 2: Clarification
  - Stage 3: Filter Press
- Teardown and decontamination
- Demobilization of crew and equipment

### 1.2 Proposed Personnel & Equipment

#### 1.2.1 Personnel

The on-site project staff will include the following:

- One SECURE Project Manager – half time (plus 4 site visits)
- Two SECURE Water Superintendent – one for each shift (day and night shift)
- Ten SECURE Water Technicians – five crew members for each shift (day and night shift)

#### 1.2.2 Equipment

The proposed water treatment system(s) shall include the following equipment

- Overall Water Treatment Project
  - 4 light-duty pickup trucks for crews (two for each shift)

- One Mobile Command Unit
- Stage 1: Neutralization
  - One intake float
  - One 6-inch dry-prime stainless steel diesel pump
  - Two mobile mix tanks
  - 700 feet of acid-resistant hose
  - Additional hose and miscellaneous fittings and connectors
  - One 5,500-lb telehandler
- Stage 2: Clarification
  - One 6-inch dry-prime pump
  - One 48-foot diameter C-ring tank
  - Additional hose and miscellaneous fittings and connectors
- Stage 3: Filter Press
  - One 6-inch dry-prime pump
  - One mobile mix tank
  - Two mobile filter presses
  - Two cake bins
  - Additional hose and miscellaneous fittings and connectors
- Secondary containment
  - Additional liners and tank for secondary containment

Equipment Profiles for SECURE’s filter press, C-ring clarifier and mix tanks are presented in **Appendix A**.

### **1.2.3 Sub-Contractors**

Subcontractors for this project will include:

- Mohsen Barkh – Process Engineer
- Western Tank and Lining – tank installation and dismantling crew; secondary containment installation
- Various vendors – transportation vendors for mobilization and demobilization

### **1.2.4 Materials & Consumables**

The following materials and consumables will be used for this project:

- Off-Spec Magnesium Oxide in 1-metric-tonne supersacs for neutralization stage

### **1.2.5 Backup Equipment & Materials**

SECURE will also have available the following backup equipment and materials for the project:

- 4-inch dry-prime pump
- Two Filter cloths

### 1.3 Project Execution Plan

#### 1.3.1 Design Phase & Desk-Top Study

SECURE will require a sample of the Pond #6 water to conduct a Desk-Top Study of the process to confirm that the proposed process will achieve the goals of the project. This study will be completed by a third party Process Engineer. Following completion of the desk-top study, the process engineer will either confirm the design parameters or refine the design to achieve the project goals.

Once the design has been confirmed or refined, a report will be submitted to Vale for their review and comments. Once approved, SECURE will proceed to the next steps in the project.

The current design by Mohsen Barkh (P.Eng.) is included at the end of this document and provides information related to the neutralization of using MgO as well as flow drawings showing the basic design (**Appendix B**).

The design of this system is intended to achieve the following:

- Stage 1 – Neutralization
  - Neutralize the pond water to raise the pH from pH 1 to approximately pH 9
  - Commence the chemical reaction between the Magnesium Oxide and the pond water
- Stage 2 – Clarification
  - Allow the chemicals in the neutralized water to chemically react and precipitate heavy metals within the clarifier
  - Collect the precipitate from the base of the clarifier for extraction
- Stage 3 – Filter Press
  - Collect the precipitate sludge from the base of the clarifier and press it to form a filter cake

#### 1.3.2 Mobilization

SECURE will mobilize crew and equipment from various locations including Calgary AB, Edmonton AB, Fort McMurray, and/or Richmond BC. Equipment will be transported to Vale Thompson using tractors and flat deck trucks.

SECURE assumes that there will be a designated laydown area assigned to our project:

- A suitable level area is required for the mix tanks, clarifier tank and filter press operations laydown for all SECURE equipment.
- Equipment electrical connections will be established, checked, tested and powered up.

#### 1.3.3 Equipment Setup

This project will include three stages of processing/management, for which the following sections describe the setup and commissioning:

- Stage 1: Neutralization
- Stage 2: Clarification

- Stage 3: Filter Press

A crew of six SECURE personnel (one Water Supervisor and five Water Technicians) will setup and commission the system over approximately five (5) day-shifts. In addition, a third party tank installer (Western Tank and Lining) will have a crew of 4 for ten (10) day-shifts to install the clarifier tank and secondary containment of the various stages of the water treatment system.

The following sketch provides a flow diagram describing the entire water treatment configuration:

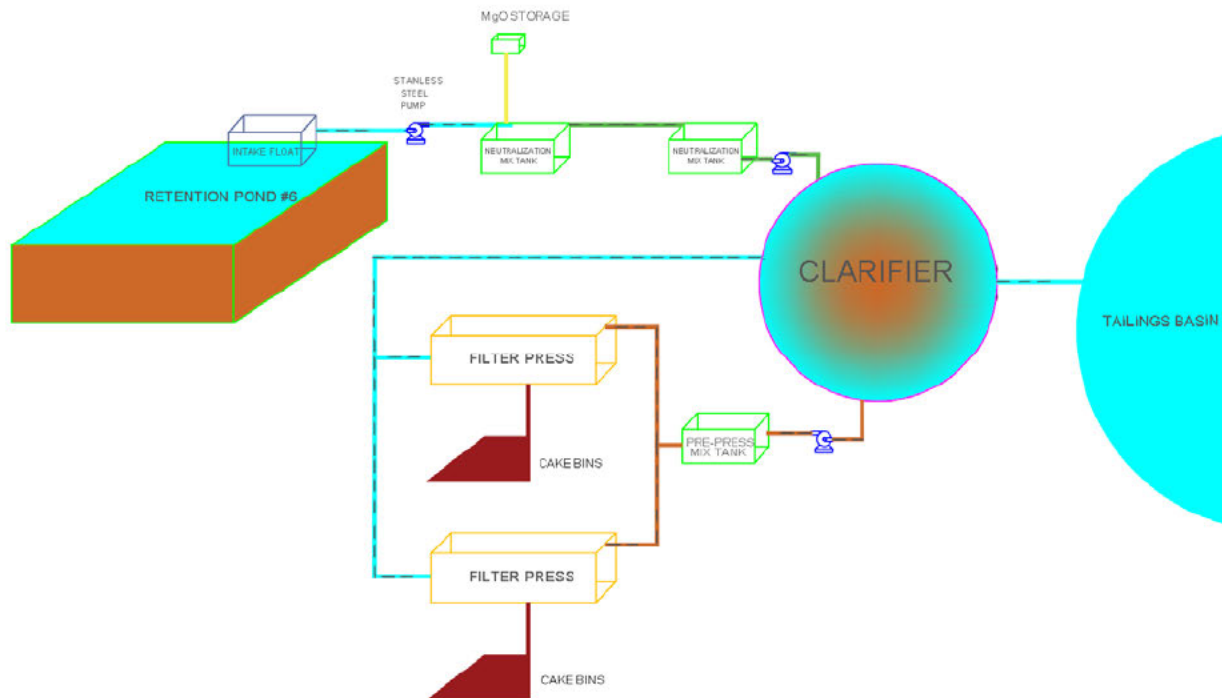

### 1.3.3.1 General Setup

General requirements for the entire project will include:

- Level staging area for all equipment, including an area for the clarifier where earthworks can be completed to create a recessed conical tank base
- Light facilities for night shift work
- Water supply for decontamination

### 1.3.3.2 Secondary Containment

Prior to construction/assembly of the water treatment stages, SECURE will install secondary containment liners in the laydown areas where the water treatment components will be staged/constructed.

WTL will install a large ring tank within which the C-Ring Clarifier will be assembled (see Section 1.3.3.4 below). Note that the sequence of the construction of the clarifier and its secondary containment will be completed in such a way to facilitate the design of the clarifier described below.

Secondary containment will be designed and constructed in such a way to contain 110% of the volume of each component in the water treatment system.



### **1.3.3.3 Setup of Stage 1: Neutralization**

SECURE crew will construct the following system for the neutralization stage:

- Connect the power supply as described above to the neutralization mix tanks
- Installation of the intake float in Vale Pond #6 and a stainless steel dry-prime pump adjacent to the pond
- Acid-resistant hoses will connect the float to the pump and continue to two neutralization mix tanks (likely in series)
  - These mix tanks are intended to allow SECURE to add Magnesium Oxide to neutralize the pH in the pond water from pH of 1 to a pH of approximately 9
- Hose will be assembled from the mix tanks via a 6-inch dry-prime pump to an HDPE connector pipe at the clarifier (Stage 2).

#### **Neutralization Output – Neutralized Water**

- Neutralized slurry will be directed to the clarifier (Stage 2)

### **1.3.3.4 Setup of Stage 2: Clarification**

SECURE crew will construct the following system for the clarification stage:

- SECURE crews will prepare the site of the C-ring clarifier (and its secondary containment) using heavy equipment
  - The area will be leveled and a layer of 18 inches of ¾-inch minus gravel will be laid on top
  - The gravel will be compacted to 95% proctor
  - The centre of the clarifier base will be constructed in a recessed conical shape to encourage downward flow of precipitate to a low point near one of the walls of the tank
- Western Tank and Lining crew will assemble the c-ring tank and its secondary containment tank on the prepared surface
  - A geotextile liner will be laid on the ground before the walls are assembled
  - The corrugated steel walls of the tank will be lifted and bolted into place over the geotextile.
  - Once the walls of the tank are assembled, WTL will install the 60-mill liner with a sump and HDPE pipe system in the low point of the conical base.
  - The liner will be folded over the top edge of the tank walls and attached to the outside of the wall with metal flashing.
- SECURE crew will assemble hosing/piping from the outlet of the neutralization mix tanks to fixed HDPE pipe at the clarifier
  - The HDPE pipe will be constructed to conduct the water flow over the wall of and into the clarifier.

#### **Clarifier Output – Precipitate Slurry**

- SECURE will install hosing/piping to the clarifier sump piping; this hosing/piping will draw sludge from the base of the clarifier and direct it to the filter presses using a 6-inch dry-prime pump.

#### Clarifier Output – Clear Water

- SECURE will install a gravity-fed discharge pipe near the top portion of the clarifier tank
  - From this gravity-fed port, SECURE will assemble piping/hosing that feeds water from the clarifier to Vale Tailings Basin

#### **1.3.3.5 Setup of Stage 3: Filter Press**

SECURE crew will construct the following system for the filter pressing stage:

- Connect the power supply as described above to the filter presses and associated equipment.
- SECURE will install a pump and pre-press mix tank between the clarifier and the mix tank
  - This pre-mix tank is intended to keep the sediment received from the Clarifier in suspension for the distance it is required to be pumped.
- SECURE will assemble piping/hosing from each end of the mix tank to one of the two filter presses.
- SECURE will install piping from the blow down back to the pre-press mix tank for recirculation.

#### Filter Press Output – Filter Cake

- SECURE will set up a cake box at each filter press to receive the pressed filter cake batches.
  - SECURE will use a loader to move the cake boxes to a location designated for collection of the filter cake; Note that SECURE would be able to procure a loader for an additional cost.

#### Filter Press Output – Effluent Water

- SECURE will assemble a system of pipes and hoses to direct the effluent water from the filter press to back to the clarifier

#### **1.3.4 Commissioning of the System & Operation**

Commissioning of the system will require a crew of six (6) SECURE personnel (one Water Supervisor and five Water Technicians) for day-shifts. The operation phase of the project will require twelve (12) SECURE personnel (two Water Supervisors and ten Water Technicians) for two shifts: day shift and night shift as follows:

- 2 Water Supervisors (1 per shift)
- 8 Water Technicians for the filter presses (2 per press per shift)
- 2 Water Technician as support for the remainder of the treatment process (1 per shift)

#### **1.3.4.1 Commissioning the Neutralization and Clarification (Stages 1 and 2)**

SECURE will commission Stage 1 and Stage 2 of the water treatment system(s) as follows:

- SECURE crew will complete a full system inspection including pipelines and connections prior to commencing the commissioning phase; all valves will be opened.
- The system will be tested by drawing a predetermined volume of pond water and a specified volume of magnesium oxide into the mix tanks.

- Pond water will flow into two mix tanks (in series); magnesium oxide (MgO) will be added to the first of the mix tanks to neutralization the water (raising the pH from approximately pH 1 to approximately pH 9)<sup>1</sup>.
- Water in the mix tank(s) will be mechanically agitated until the MgO is dissolved.
- The pH will be tested using a hand-held meter; if the pH is not at the recommended level, more MgO will be added and quantities documented.
- When the desired pH is reached, the neutralized water will be pumped into the clarifier to continue the chemical reaction and for settling of any precipitate resulting from the increase in pH.
- The above-described batching process will be repeated and the clarifier will continue to be filled; the crew will monitor the clarifier to ensure that the precipitate is settling out as anticipated.
- The crew will continuously inspect the system to ensure that there are no leaks and that all equipment is operating as expected.

#### **1.3.4.2 Commissioning of the Filter Presses (Stage 3)**

SECURE will commission Stage 3 of the water treatment system(s) as follows:

- The crew will monitor the sludge at the base of the clarifier; when the sludge appears to be at an optimal density, the crew will pump the sludge/slurry from the clarifier sump at the base of the conical clarifier to the pre-press mix tank.
- The crew will operate the pre-press mix tank to keep the sludge in suspension.
- When the tank contains more than 70 cubic metres of slurry, one of the valves (at either end of the mix tank) will be opened and flow will be directed to one of the filter presses.
- The press will draw slurry from the mix tank and feed the voids in the press; as the flow of slurry pushes into the press, water will be released through the filter cloth and dewatered through four channels on the press.
- When the pressure builds in the press and a cake develops; at 100 pounds per square inch (psi), the slurry pumping will be discontinued.
- The press will be blown down to evacuate any loose slurry (sludge and residual water) back into the pre-press mix tank.
- The conveyor will be activated and the filter press hydraulic pressure will be released.
- The press will be opened and the plates separated one at a time; filter cake will be manually removed from the void in each plate as it is opened, dropping the filter cake onto the conveyor.
- The conveyor will move the filter cake to the cake bin.
- The crew will continuously inspect the system to ensure that there are no leaks and that all equipment is operating as expected.

#### **1.3.4.3 Operations Phase**

For the operation phase of the project, SECURE will run the above-described treatment system in the same manner as during the commissioning phase with the following modifications:

- Water will be pumped from Pond #6 continuously into the 3 Stages of the process.
- The system is designed to reach and maintain a continuous flow capacity of 600 gallons per minute (approximately 870 cubic metres per day) from the pond.

---

<sup>1</sup> The process engineer will determine the appropriate target pH for this stage of the treatment system

- pH will be routinely monitored in the Neutralization mix tanks to ensure that enough MgO is being added to the mixture to reach the optimal design pH.
- The crew will continuously inspect the system to ensure that there are no leaks and that all equipment is operating as expected.

Operations will also include:

- SECURE is to provide Project Management, Site Supervision, and off-site Safety support to facilitate the safe and efficient operation of the project while meeting Vale HSE and other project-related requirements.
- The SECURE crew will consist of one Water Supervisor and five Water Technicians for each of the day and night shifts (total of 12 people).
- After setup and commissioning, SECURE will operate 24 hours continuously, for approximately 42 calendar days.
- Crews will be swapped in/out every 14 days.
- Operational shifts are based on 12-hour shifts, with the majority of the shift as operation/time, less standard time for a pre-shift safety meeting, required breaks and lunch. The day shift is generally 7:00 AM – 7:00 PM, and the night shift is generally 7:00 PM – 7:00 AM.
- Once precipitate from the clarifier is filter-pressed, filter cake will be conveyed into steel boxes or cake bins at the end of each press for retrieval by Vale. SECURE can provide this service if requested.
- SECURE is not responsible for obtaining permits, reporting, sampling material or analytical testing. SECURE can provide these services if requested.

#### **1.3.4.4 Expectations from Vale**

Vale shall supply the following for this project:

- A Restricted SECURE work area: access to this area must be authorized and documented by Vale.

#### **1.3.5 Confirmation Sampling & Analytical**

As a confirmation of the system design, SECURE will collect samples of the water as follows:

- Commissioning Phase
  - 1 sample per day from surface of the water in the clarifier as it is being filled
  - 3 sample per week of the slurry from the neutralization mix tanks
  - Total of 10 samples
- Operations Phase (Weeks 1 and 2)
  - 1 sample per day from the clarifier outlet pipe leading to the tailings basin
  - 3 samples per week of the slurry from the neutralization mix tanks
  - Total of 20 samples
- Operations Phase (Weeks 3 through 7)
  - 2 samples per week from the outlet pipe leading to the tailings basin
  - Total of 10 samples
- Contingency
  - Additional samples will be collected as necessary

Samples will be analyzed for total metals, dissolved metals, total suspended solids and pH. Samples will be delivered to a certified laboratory via overnight courier and analysis will be requested for 2-day turnaround.

If at any point the analytical results show concentrations of any parameters exceeding tailings basin background levels, SECURE will revisit the water treatment process and modify the design to address the exceedances.

### **1.3.6 Teardown & Decontamination**

SECURE will deconstruct and decontaminate all equipment associated with the above systems as follows:

- All piping and hosing will be disassembled from the large pieces of equipment.
- Western Tank and Lining will mobilize to site to deconstruct the clarifier tank and collect the liners and geotextiles
  - If liners and geotextiles will be rinsed of any hazardous material, collected and hauled to a landfill for disposal at an approved recycling/disposal facility.
  - Steel walls of the tank will be disassembled and pressure washed.
  - Corrugated steel walls will be washed and stacked for off-site mobilization
- All of the SECURE equipment will be disassembled and decontaminated including:
  - Three mix tanks
  - C-ring clarifier
  - Two filter presses
  - Two cake bins
  - Three pumps
  - Hoses/piping and fittings
- All equipment will be flushed with water; SECURE will dispose of all wash water into Pond #6 or the Tailings Lagoon as advised by Vale.
- SECURE will clear the work area to a condition equivalent to that upon arrival.
- At Vale's request, some equipment may remain on site for future projects.

### **1.3.7 Demobilization**

SECURE will demobilize crew and equipment to various locations including Calgary AB, Edmonton AB and/or Richmond BC. Equipment will be transported from Vale Thompson using tractors and flat deck trucks. SECURE will escort all transport trucks onto and off of the site to facilitate loading.

## **1.4 Site-Specific Safety**

SECURE will prepare a Site-Specific Safety Binder that will include (but not limited to) the following

- Site-Specific Health and Safety Plan,
- Emergency Response Plan,

- Job Safety Analyses, and
- Standard Operating Procedures.

#### 1.4.1 Daily Safety Activities

The Water Supervisor will be responsible for daily oversight of tasks performed including:

- Participating in daily tailgates,
- Field JSA development and review,
- Field Level Hazard Assessment (FLHAs) review,
- Site inspections,
- Hazard ID review,
- Safety statistics,
- Safety reporting,
- Completing behavioral task observations sheets (BTOS).

### 1.5 Project Schedule

#### 1.5.1 Overall Schedule

The overall project schedule is anticipated to be as follows:

Task	Duration
Design & Desk-Top Study	10 days
Mobilization	1 day
Crew Orientation	1-2 days
Equipment Setup & Commissioning	14 Days
Operation	42 days
Teardown & Decontamination	12 Days
Demobilization	1 day

#### 1.5.2 Daily Activities

The following sections provide a summary of the anticipated daily activities during the project.

##### 1.5.2.1 Daily Permits and FLHA Preparation

Prior to any field work, the SECURE Water Supervisor will prepare and submit for approval daily Permits and Field Level Hazard Assessments. Once approved, field work can commence.

### **1.5.2.2 Daily Tailgate and Coordinating with Sub-Contractors**

The daily tailgate meeting will be held prior to work starting each morning. This serves as the opportunity for site personnel to discuss previous shift safety performance and review new or revised procedures or corporate communications. The typical daily tailgate agenda includes:

- The scope of work to be carried out for the shift,
- Assigned duties of project staff and sub-contractors at or arriving to the site that day,
- Identified work hazards such as hazardous materials in the work area, planned daily abatement and demolition areas, traffic flow and weather,
- Applicable JSAs and risk reviews, specifically control measures that are in place to minimize or eliminate worksite hazards,
- Expected processes and material handling
- Emergency response plan relevant to the specific work areas,
- Instruction on Best Practices as required,
- Previous day incidents, near misses, hazard IDs, trends and/or report findings, and
- Safety communications as provided by Teck, SECURE, sub-contractors, or vendors.

As with all project meetings, these will be documented by SECURE and available for distribution upon request. These documents will provide the basis and foundation for reviewing project performance, project objectives, new or changed risks, changes in scope, decisions on sequencing and other management of change items.

### **1.5.2.3 Shift Cross-Over Meeting**

Between day shift and night shift, the water supervisors will meet to share information and go over the day's work, project progress, health and safety issue encountered and plans for the following day.

Attendees might also include the project coordinator/manager, and representatives from sub-contractor(s). Teck representatives are invited to attend as they feel necessary. This coordination meeting will be documented and will serve as a forum to share key information, developments, needs and requests with the project team, for the net benefit of all involved.

## **1.6 Assumptions and Clarifications**

1. Following Desk-Top Study, SECURE will revised the project approach and this estimate to reflect the findings of the System Design.
2. This project has been estimated using Off-Spec Magnesium Oxide, the supply of which is not always guaranteed. In the event that Off-Spec MgO is not available, SECURE will communicate with the client and provide details about costing and schedule related to procuring Spec MgO
3. Crew size will be:
  - a. SECURE Project Manager (half time plus 4 site visits)
  - b. Setup (day shift only)
    - i. 1 SECURE Water Supervisor for setup and commissioning
    - ii. 5 SECURE Water Technicians for setup and commissioning
    - iii. Up to 5 WTL crew members for assembling c-ring clarifier tank (10 day shifts)
  - c. Commissioning & Operation (day and night shift)
    - i. 2 SECURE Water Supervisors (1 for each shift)
    - ii. 8 SECURE Water Technicians (2 per filter press per shift)

- iii. 2 SECURE Water Technicians as an added hand (1 for each shift)
- 4. The open-top tank required level ground prior to installation. SECURE can provide earthworks crews to prepare this area, but no provision has been carried at this time.
- 5. The need for the Process Engineer to visit the project additional times will be invoiced on a time and materials basis.
- 6. The above is based on a 14 days on / 14 days off rotation for the crews.
- 7. Clean water for decontamination and for pressure washing is anticipated to be provided by Vale.
  - a. In the event that additional hoses/piping is required for the system, these will be invoiced to the client based on the T&M rates in the detailed summary attached to this quotation.
- 8. No allowances have been made for
  - a. Transport or disposal of any hazardous materials.
  - b. The collection, storage, transport or disposal of any surface or groundwater.
  - c. Any utility conflicts, rerouting of utilities, and support or protection of utilities or hydro-vac exposing utilities. These services can be provided at a cost-plus 15% basis.
  - d. Road bans or bridge restrictions.
  - e. Freezing temperatures during operation; if this project extends into the late fall or winter, SECURE will require equipment to maintain flow in our system without freezing, such as a Frost Fighter.
- 9. All work is to take place on a continuous basis – no allowance for any standby.
- 10. All required permits and approvals to be obtained by others.



## **APPENDIX A: EQUIPMENT PROFILES**



## Mobile Mix Tank

### Specifications

- **Dimensions**
  - 50 feet long, 8 feet wide, 12 feet tall
  - Electric mixer motors
  - Top, side and front access hatches
- **Power requirements**
  - 60 amp; 3-phase 480 Volt
- **Inlets and outlets**
  - 3-inch and 4-inch camlock

### Applications

- Maintaining slurry in suspension
- Mixing additives into process liquid
- Thickening process water
- Create a slurry from fine solid material

The mix tank is an open compartment vessel with three or four mixers; the tank has secured steel-mesh walkways and staircase with railings.





## Fixed Ring Clarifier

### Specifications

- **Dimensions**
  - 48-foot diameter
  - Range from 2 to 4 rings (equivalent to 6 to 12 feet)
  - Bolted corrugated galvanized steel panels
  - Panels bolted to angle iron base
  - HDPE liner ranging from 3mm and 20 mm thickness
- **Installation requirements**
  - Mobilized using a single flat deck load
  - Crew of 4 can install the tank in 5 working days

### Applications

- Retention pond
- Process tank
- Fisheries
- Film Industry
- Water storage
- Fire suppression
- Clarification of chemical process precipitate

The fixed-ring clarifier facilitates the separation of large volumes of solids from liquids.



# Mobile Filter Press

## Specifications

- **Dimensions**
  - 53 foot soft-sided tri-axle trailer; mobilized using a conventional tractor truck
  - Between 90 and 110 plates (depending on unit)
  - Between 80 and 100 square feet per plate (depending on unit)
- **Power requirements**
  - Requires 100 amps; 3-phase 480 Volt
- **Inlets and outlets**
  - 4-inch inlet to the diaphragm pumps
  - 3-inch outlets for the centre-core blow-down and filtrate water
- **Onboard diaphragm pump**
  - Two 3" clamped Versamatic AODD pumps
  - 230 GPM at start up / 100 psi operating pressure
  - Stainless steel wet side
  - Max suction lift 32' wet and 20' dry
  - Weight 180-200 lbs
  - Max 96 db(A)
- **Onboard air compressor**
  - Ingersoll Rand 50 HP rotary screw
  - 118 max psi / 220 CFM
  - 460V; 3-phase
- **Material conveyor**
  - 30' long & 42" wide
  - 460V; 3-phase motor
- **Filter cloth**
  - Generically uses 5 cubic feet / minute filter cloth

The filter press is a mobile unit used to separate solids from liquid. This system uses filter clothes attached plates that are pressurized against each other to separate the liquid and solid phases of effluent. This is a non-continuous process that needs to stop regularly to empty the condensed solids (known as cake) that forms between the plates during the separation stage.

The filter press operation process is divided into five recurring steps:

- Closing the press
- Filtration
- Recirculation
- Drying the cakes
- Dropping the cakes

## Applications

- Reduction of the volume of waste for disposal by separating the liquid and solid phases
- Reduction of need for stabilization additives
- Metals extractions from processes
- Pond cleaning



## **APPENDIX B: PROCESS ENGINEER DESIGN AND DRAWING**



RECENS

Phone: 778-991-5468

Vancouver, BC

Email: [mohsen@recens.ca](mailto:mohsen@recens.ca)

EGBC# 1000691

## **STATEMENT OF WORK # 318-R.5**

### **Water Treatment Consulting Services**

### **For Vale Mine- Neutralization Project-SOW**

prepared for

**SECURE ENERGY SERVICES Inc.**

**March 04, 2022**

The information contained in this document (including any attached or accompanying materials), any other documents, data or information produced by RECENS or any related discussions or negotiations is proprietary to RECENS and strictly confidential. This document is intended solely for the use and evaluation of the intended recipient and it may not be disclosed, used or reproduced by any person or entity except to the extent expressly authorized in writing by RECENS.

This response and any services offered hereunder will be governed by RECENS' General Conditions of Service in the absence of a definitive agreement negotiated and executed by the parties. RECENS takes exception to any provisions offered otherwise which purport to establish any contractual or legal terms under which RECENS will provide services.

No statement contained herein or made by RECENS in its response shall be construed as any representation or warranty on behalf of RECENS, including, but not limited to implied warranties of fitness for a particular purpose or merchantability or any other representation or warranty.

 <b>RECENS</b> EGBC#1000691	CLIENT	<b>SECURE ENERGY SERVICES Inc.</b>	REV.:	05
	TITLE	<b>Vale Mine- Neutralization Project-SOW</b>	DATE:	<b>March 04, 2022</b>

## STATEMENT OF WORK

The current revision of this document was prepared after the Vale Nickle Mine decided to use magnesium oxide as the most suitable neutralization reagent. It was decided to send the neutralized water to the tailings basin and use two filter presses for generating stackable solid waste. Also, the operation team in Secure Energy decided to inject magnesium oxide directly to the first neutralization mix tank.

### Introduction

The following technical portion of the Statement Of Work (SOW) was developed as a high-level document to explain the overall approach of Secure Energy Services to the proposed “pond neutralization” project at Vale Nickle Mine. The proposed work covers the use of solid magnesium oxide (MgO) as the neutralization reagent. The following sections explain the advantages and limitations of the selected reagent as well as related on-site operation procedures

### Magnesium Oxide Neutralization

The neutralization process could be defined as reducing the concentration of hydrogen ions in a liquid with a pH lower than 7 (in this case water) by increasing the concentration of hydroxide ions in the solution. The common product of the neutralization reaction is water as presented in Equation 1 :



In a normal situation, hydrogen ions can't exist in the water without being attached to an anion with negative charges. Similarly, the hydroxide ions can't be introduced to the acidic water (in the chemical neutralization process) without having a company of the cations. In the Vale mine water, the abundant anion in the water is sulphate and the selected neutralization reagent is magnesium oxide. Therefore the molecular form of the previous equation would be as follows:

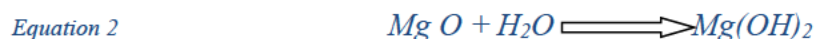

In addition, due to introducing magnesium hydroxide to the water the existing metals such as copper and nickel which are in touch with the sulphate ions in the water would be replaced by magnesium and converted to insoluble metals hydroxides as illustrated in Equation 4 :

File Location	Prepared By:	Revision	Page Number
C:\Users\mohse\Desktop\RECENS\Secure Energy\Vale Mine\Design Document	MB	05	Page 2 of 7

 <b>RECENS</b> EGBC#1000691	CLIENT	<b>SECURE ENERGY SERVICES Inc.</b>	REV.:	05
	TITLE	<b>Vale Mine- Neutralization Project-SOW</b>	DATE:	<b>March 04, 2022</b>

Equation 4



The formation of insoluble metals hydroxide generates solids that could be removed from the water as a sludge via a settling process. While magnesium sulphate will stay in the water due to its high solubility. The water neutralization at the Vale site was designed based on using magnesium oxide considering the following advantages and limitations of the magnesium oxide as a neutralization reagent.

### a. Advantages

- 1- Magnesium oxide in the water will produce magnesium hydroxide which is a mild base with a slow reaction rate.
- 2- The alkalinity power of magnesium oxide is almost 2 times higher than the sodium hydroxide; therefore, using magnesium oxide will reduce the volume of the required reagent by almost 50%.
- 3- The generated sludge after magnesium hydroxide precipitation has less volume and higher solids content.
- 4- Due to buffering property of the magnesium hydroxide the maximum pH of the solution will be in the range of 9 to 9.5 without any risk of pH overshooting.
- 5- The binding property of the magnesium would prevent leaching and redissolving the precipitated metals.
- 6- Unlike other neutralization reagents, magnesium hydroxide is not a hazardous material and could be easily handled without special equipment.

### b. Limitations

Despite all of the advantages of magnesium oxide, there are limitations on its usage which should be considered for reagent selection:

- 1- Hydration of the magnesium oxide is a slow process and required a mixing chamber with a minimum of 60 minutes retention time.
- 2- Dissolving magnesium oxide in the water is an exothermic reaction. Therefore, the solid should be dissolved slowly to dissipate the generated heat and prevent undesirable situations. Alternatively, a magnesium hydroxide slurry with a 65% solids concentration could be used as the neutralization reagent.
- 3- Due to the high solubility of the magnesium sulphate, in the vale site, the use of magnesium oxide (unlike lime) maintains a high concentration of the sulphate in the liquid phase which might have some negative impact on discharging water to

File Location C:\Users\mohse\Desktop\RECENS\Secure Energy\Vale Mine\Design Document	Prepared By: MB	Revision 05	Page Number Page 3 of 7
--	--------------------	----------------	----------------------------



 <b>RECENS</b> EGBC#1000691	CLIENT	<b>SECURE ENERGY SERVICES Inc.</b>	REV.:	05
	TITLE	<b>Vale Mine- Neutralization Project-SOW</b>	DATE:	<b>March 04, 2022</b>

the receiving environment. It is recommended to review the sulphate concentration limitations in the related jurisdiction as a preventive measure.

## SOW Using Magnesium Oxide

### a. Major Equipment

The solid magnesium oxide was selected for this operation due to its non-hazardous nature and cost-efficient transportation options. The required equipment for injecting magnesium oxide into the pond is as follows:

- 1- 1X 6" Dry prime stainless steel centrifugal/diesel pump
- 2- 1X Suction on a float 90deg fitting into the water
- 3- 3X Stainless steel 18,000-gallon mix tank with a minimum of four mixing chambers
- 4- 1X Clarifier tank with minimum 10 m diameter
- 5- 2X 6" Slurry transfer pump
- 6- 1X Solids jumbo bags handling equipment
- 7- Sufficient amount of acid resistance feed hose
- 8- Sufficient amount of slurry transfer hose
- 9- 1X 480-volt generator
- 10- 2X Filter press

### b. Process Description

Figure 1 illustrates the pond neutralization using solid magnesium oxide with filter press option. The system was designed to pump water from the pond to the neutralization unit. The system was designed based on direct injection of the solid magnesium oxide to the feedwater in the neutralization mix tank.

A proportional amount of magnesium hydroxide slurry, based on the laboratory test work and water flow rate, would be added to the feed stream inside the first mixing chamber and after complete mixing, the slurry would be transferred to the next chamber for additional mixing/reaction time. The mixing and neutralization reaction would continue in the next three chambers of the first mix tank as well as the second mix tank.

Since the pH of magnesium hydroxide solution, regardless of the reagent consumption, can't exceed 9.5, pH measurement won't be used as a control parameter. Therefore, using a pH measuring instrument and pH controller wasn't considered for this

File Location	Prepared By:	Revision	Page Number
C:\Users\mohse\Desktop\RECENS\Secure Energy\Vale Mine\Design Document	MB	05	Page 4 of 7

 <b>RECENS</b> EGBC#1000691	CLIENT	<b>SECURE ENERGY SERVICES Inc.</b>	REV.:	05
	TITLE	<b>Vale Mine- Neutralization Project-SOW</b>	DATE:	<b>March 04, 2022</b>

operation. The neutralized pond water would be transferred to a clarifier with a minimum 10 m diameter to provide sufficient retention time for the solid settling process.

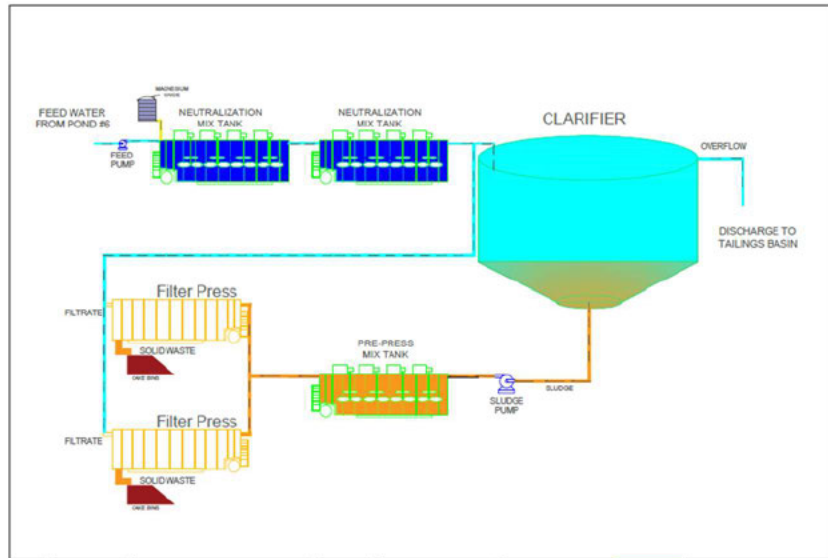

Figure 1: Pond Water Neutralization Using Magnesium Oxide

The clear overflow from the clarifier could be transferred to the tailings basin by gravity as the neutralized water while the copper and nickel rich sludge would be pumped from the bottom of the clarifier as valuable underflow. Although recirculating sludge of magnesium hydroxide (unlike sludge of the lime neutralization) doesn't have any positive impact on the quality of the water, sludge recycling might increase the solids content of the underflow from the clarifier. The impact of sludge recycling needs to be investigated in process development tests before implementing it on large-scale operations. The underflow from the clarifier will be pumped to a mix tank before introducing to the filter presses. The well-agitated slurry will be fed to filter press units to produce stackable sludge while the separated liquid (filtrate) will be recycled to the clarifier feed stream.

### c. Operational Steps

The stages of the neutralization process could be summarized as follows:

- 1- Pump acidic water from the pond to the mix tank using float suction and diesel pump,
- 2- Use feed water to convert magnesium oxide to magnesium hydroxide slurry,
- 3- Add magnesium hydroxide slurry as neutralization reagent to start neutralization process,

File Location	Prepared By:	Revision	Page Number
C:\Users\mohse\Desktop\RECENS\Secure Energy\Vale Mine\Design Document	MB	05	Page 5 of 7

 <b>RECENS</b> EGBC#1000691	CLIENT	<b>SECURE ENERGY SERVICES Inc.</b>	REV.:	05
	TITLE	<b>Vale Mine- Neutralization Project-SOW</b>	DATE:	<b>March 04, 2022</b>

- 4- Provide a minimum of 60 minutes of high-intensity agitation to hydrated magnesium oxide and promote neutralization reaction,
- 5- Use gravitational flow to discharge neutralized solution to the large clarifier,
- 6- Discharge clarifier overflow as treated water to an empty pond or storage,
- 7- Use a 6" slurry transfer pump to transfer clarifier underflow to a storage tank,
- 8- Dewater slurry using filter press to generate stackable solid waste and return filtrate to the treated water storage.

File Location	Prepared By:	Revision	Page Number
C:\Users\mohse\Desktop\RECENS\Secure Energy\Vale Mine\Design Document	MB	05	Page 6 of 7

 <b>RECENS</b> EGBC#1000691	CLIENT	<b>SECURE ENERGY SERVICES Inc.</b>	REV.:	05
	TITLE	<b>Vale Mine- Neutralization Project-SOW</b>	DATE:	<b>March 04, 2022</b>

## DISCLAIMER

This design has been prepared by Recens Mine Water Consulting (“Recens”), as the water treatment technical expert (s), in accordance with generally accepted engineering consulting practices in this area for SECURE ENERGY SERVICES Inc. (“Secure”). No other warranty, expressed or implied, is made.

The design has been prepared for the specific site, development, design or building assessment objectives and purpose that were described to Recens by Secure. The applicability and reliability of any of the findings, recommendations, suggestions, or opinions expressed in the document are only valid to the extent that there has been no material alteration to or variation from any of the said descriptions provided to Recens unless Recens is specifically requested by Secure to review and revise the design in light of such alteration or variation.

It is understood and agreed that Secure has provided Recens with the accurate and complete information necessary to compile the requested conceptual/basic design. Recens prepared the treatment design using the information provided by Secure. Recens will not audit, review or otherwise attempt to verify the accuracy or completeness of any information provided. The responsibility remains with Secure. The design is issued with the following label:

PREPARED SOLELY FOR VALE MINE- NEUTRALIZATION Project-SOW  
PROCESS USING AVAILABLE EQUIPMENT AT Secure WITHOUT AUDIT OR REVIEW FROM INFORMATION PROVIDED BY Secure.

This communication will appear with the name “Recens Mine Water Consulting” as the technical advisor. Should the client ask Secure for additional information or require explanations relating to the design Recens prepared for Secure, Recens will provide Secure with all the needed help. Recens wishes to emphasize that this engagement cannot be relied on to prevent or detect errors or other irregularities in the information provided to Recens.

### **Mohsen Barkh, M.Eng., P.Eng., PMP**

Principal Senior Process Engineer,  
D: (778) 991-5468  
Email: [mohsen@recens.ca](mailto:mohsen@recens.ca)  
**Recens WasteWater Consulting Services**  
<https://recens.ca/>

File Location	Prepared By:	Revision	Page Number
C:\Users\mohse\Desktop\RECENS\Secure Energy\Vale Mine\Design Document	MB	05	Page 7 of 7

## APPENDIX C: PROCESS FLOW DIAGRAM

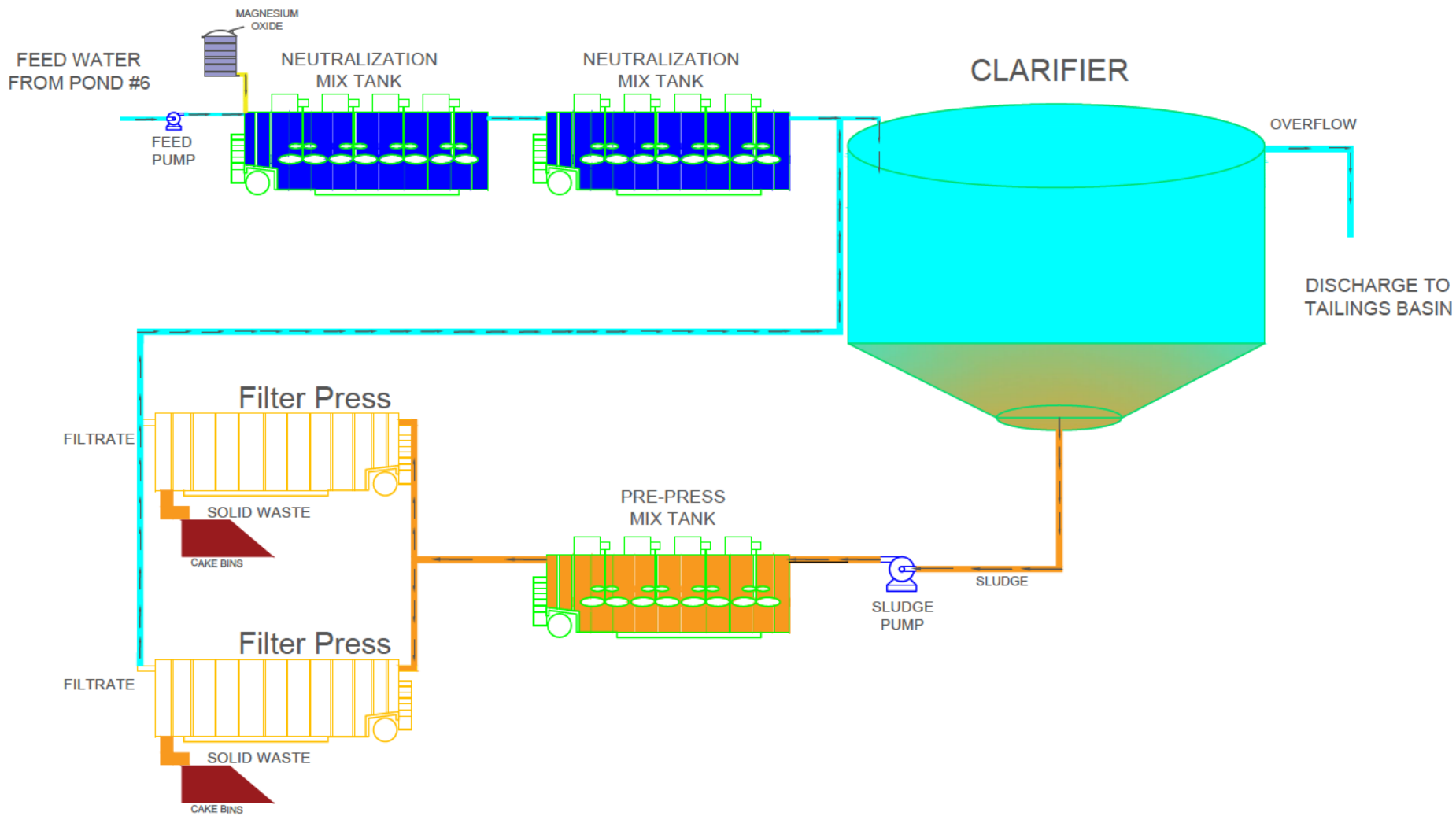

No.	Date	Note	Approved	Drawn on: MAR 04, 2022	Secure Energy Inc.	RECENS WATER Co.
5	2022-03-04	DRAFT FOR PROJECT MANAGER REVIEW	MB	Drawn By : MB	13511 Vulcan Way Richmond BC, V6V 1K4	Vancouver, BC (EGBC#1000691)
				File Location : C:\Users\mohse\Desktop\RECENS \Secure Energy\Vale Mine\Drawings		Project: VALE MINE TAILING POND NEUTRALIZATION SYSTEM

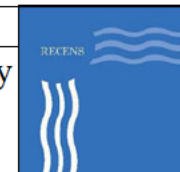

## APPENDIX C – VALE HS&E REFERENCE MATERIAL

## 1 REFERENCE MATERIALS

**SPI 10-13** Manitoba Operations Plant Site Orientation Requirements with attached CTRF and Personnel type Matrix

- Service Provider to have documented proof of their employees First Aid
- Training, Confined Space Training, Lock & Tag Procedure Training,
- Fall Arrest Training, and WHIMIS Training
- Lifting of Load
- The Confined Space Guard(s) must have
- Service Provider Injury Reporting Flow Sheet
- Thompson Mine Orientation – 013OR05
- Drug & Alcohol Expectations Letter Apr 22, 2013
- Vale Alcohol & Drug for Service Providers 22-April-2013
- SPI 10-9 PLANT PASSES
- SPI 10-10 SECURITY
- SPI 10-12 PASS OUT & RECEIPT
- SPI 20-22 EYE PROTECTION & SERVICES
- SPI 26-8 SMOKING IN THE WORKPLACE
- SPI 32-2 PPE Requirements for Electrical Personnel
- SPI 32-3 Electrical Test Equipment
- SPI 32-4 Working on Energized Equipment
- SPI 32-5 Excavation Work Permit for All Areas
- SPI 33-1 GARBAGE DUMP OPERATIONS
- SPI 34-3 HOT WORK PERMIT FOR ALL AREAS OF THE MANITOBA DIVISION
- SPI 34-8 FIRST AID TRAINING
- SPI 34-10 PROTECTIVE FOOTWEAR PROGRAM
- SPI 34-11 Plant Passes
- SPI 34-18 Eye Protection & Services
- SPI 34-21 FALL PROTECTION
- SPI 34-23 ACCOUNTABILITIES FOR SAFETY
- SPI 34-24 RESTRICTED ENTRY HAZARDOUS WORK AREAS
- SPI 34-26 ENTANGLEMENT
- SPI 34-27 STANDARD PROCEDURE FOR LOCK & TAG
- SPI 34-28 SEAT BELTS
- SPI 34-29 ADVANCED SAFETY INVESTIGATION
- SPI 34-31 INCIDENT INVESTIGATION
- SPI 34-33 CONFINED SPACE ENTRY
- SPI 34-37 HIGH VISIBILITY SAFETY APPAREL
- SPI 34-39 TRAVEL ON PLANT AND PLANT ACCESS ROADWAYS
- SPI 34-41 COLOR CODING FOR WARNING SIGNS & LIGHTS
- SPI 34-42 Introduction of Personal Protective Equipment (PPE) for Testing
- SPI 34-43 GENERAL SURFACE FIRE PROCEDURE
- SPI 34-45 CELL PHONE AND PERSONAL ELECTRONIC DEVICES
- SPI 34-47 HARD HAT POLICY



- SPI 34-49 WORKING ALONE
- SPI 34-56 Scaffold Use and Inspection
- SPI 35-3 SPILL REPORTING
- SPI 36-4 RESPIRATOR PROTECTION PROGRAM
- SPI 36-6 HANDHELD GAS DETECTION EQUIPMENT
- SPI 36-8 WHIMIS PROGRAM NOTE:
- SPI 36-19 Facial and Long Hair Policy
- CAR Requirements will require a contractor number to access online training
  - Fall Arrest Working at Heights CAR # 1 - 1238062\_NA – Online Awareness
  - Light Motor Vehicles CAR # 2 - 1237461\_NA - Online Awareness
  - Mobile Equipment Operation CAR # 3 - 1237460\_NA – Online Awareness
  - SLT&C Awareness Module CAR # 4 - 1237463\_NA – Online Awareness
  - Hoisting and Lifting CAR # 5 - 1237465\_NA Online Awareness

## APPENDIX D – ORGANIZATIONAL CHART

# Copper Pond Organizational Chart

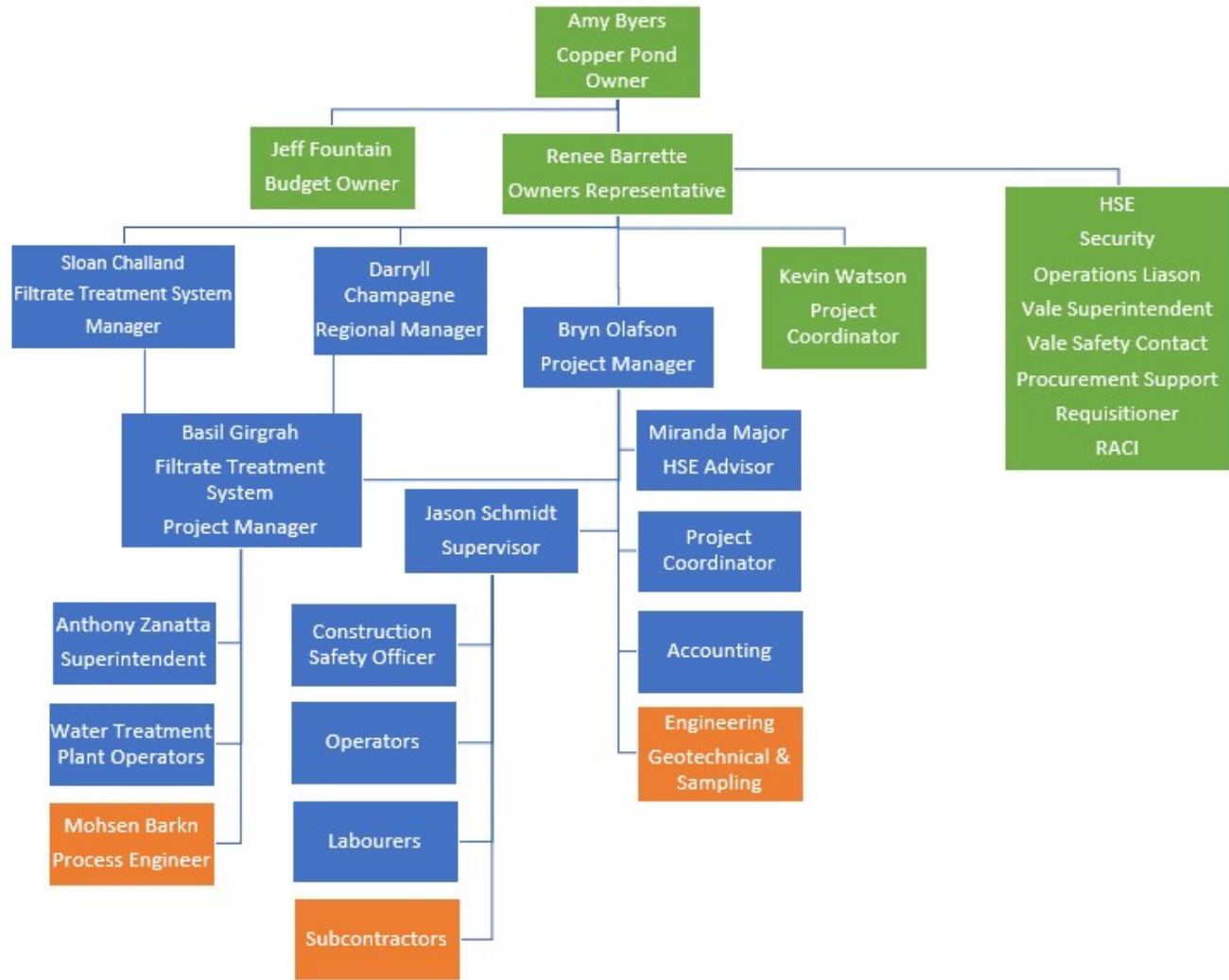

LEGEND
Vale
Secure
Subcontractor