



June 2, 2016

Tracey Braun, Director of Approvals
Environmental Approvals
Manitoba Conservation
123 Main Street, Suite 160
Winnipeg, MB R3C 1A5

Dear Ms. Braun,

RE: Amendment to 69 HW RR Hazardous Waste License for GFL Environmental Inc., Winnipeg Location

The following is a description of current operations as well as some future operations we would like to implement at 1090 Kenaston Boulevard, Winnipeg, MB.

General Information

Facility Hazardous Waste Registration Number: 004810

Permits & Licenses held/affected:

- Manitoba License 69 HW RR (the subject of this amendment)
- Manitoba Permit # 23647 for the operation of the petroleum tanks housed at the GFL Winnipeg.
- Waste Management System No. A900425 under the Ontario MOE
- MBR 04811 – Manitoba Waste Receiver Number
- MBC 20058 – Manitoba Waste Carrier Number
- MBG 04810 – Manitoba Waste Generator Number

Site Location: Lot 3, Plan 9153, WLTO in OTM Lots 60 to 63, Parish of Saint Boniface, 1090 Kenaston Boulevard, Winnipeg, Manitoba.

Site Operations Contact: Jason Henkel, Manitoba Operations Manager
(204) 987-9600
jhenkel@gflenv.com

Compliance Contact: Nola Ruhl, Compliance Manager
(780) 485-5000
nruhl@gflenv.com

Corporate Operations Contact: John Powel, General Manager
(780) 485-5000
jpowel@gflenv.com

Amendment Summary: The GFL Environmental Inc. Winnipeg site's current license is out-of-date. This was recognized in mid-November 2012 by the GFL Compliance Manager at that time (Gerald Feschuk) and the Manitoba Conservation Hazardous Waste Approvals Manager at the time (Adrian Jackson). In this meeting it was agreed that amendments would be processed as requested by GFL two years earlier. However given the workload at the time within Manitoba Conservation and then the retirement of Mr. Jackson, the amendments were never processed. The submission herein is being made to re-initiate an amendment to the current License 69 HW RR which accurately reflects current as well as some new, proposed operations we wish to implement at the site in the near future.

Background

GFL Environmental West Corp. acquired Enviro West Inc. March 28, 2011. A letter dated April 4, 2011 regarding the company name change along with necessary legal papers was submitted to Manitoba Conservation. GFL Environmental West Corp. received acknowledgement of the name change in a letter from Manitoba Conservation dated December 13, 2011.

On January 1, 2013, GFL Environmental West Corp was amalgamated with GFL Environmental East Corp into GFL Environmental Inc. Legal papers were submitted for the name change however a revised 69 HW RR was not issued. The current License 69 HW RR (August 2, 2002 revision) still has the company name "Enviro West Inc." and does not reflect current and future (planned) operations.

Ownership

The Winnipeg operation licensed under 69 HW RR, is wholly owned by GFL Environmental Inc. A copy of the Supplementary Certificates of Registration for:

- the 2011 ownership change from Enviro West Inc. to GFL Environmental Corporation West,
- the 2013 name change from GFL Environmental Corporation West to GFL Environmental Inc.,
and
- the most recent 2016 change which did not involve any name change

are all in Appendix A. The Winnipeg site land is owned by GFL Environmental Inc.

Description of Current Operations

Refer to the attached site layouts in Appendix B.

Bulk Liquid Storage (Tanks)

The Winnipeg facility receives bulk shipments of used glycol, used oils, fuels and other flammable liquids to be transferred into one of the storage tanks in the tank farm. The tanks have the following characteristics:

Tanks K1 to K12 – 12 x 120,000 liter capacity, Single-walled, Vertical tanks

Tanks P1, P2 & P4 – 3 x 60,000 liter capacity, Single-walled, Vertical tanks

Tanks P5 & P6 – 2 x 15,000 liter capacity, Single-walled, Vertical tanks

The following tanks normally contain de-ashed oil:

Tanks F1 & F2 – 2 x 630,000 liter capacity, Single-walled, Vertical tanks

Tank P3 – 1 x 60,000 liter capacity, Single-walled, Vertical tanks

Tanks P7 & P8 – 2 x 15,000 liter capacity, Single-walled, Vertical tanks

Although the current contents of the tanks are reflected above, the facility has the ability to reconfigure operations so that any tanks can contain any of the bulk liquids received or processed.

The used oil, fuel and flammable liquid tanks are used to store and blend the bulk liquids to be sold as alternate fuel to GFL customers or to store used oil for de-ashing.

The de-ashed oil tanks are used to store de-ashed oil prior to selling it to customers.

The waste glycol tank is used to store waste glycol and antifreeze prior to shipping it to a recycler to be made into reusable product.

Each tank is equipped with fittings for adding and removing product using hoses. Fuel and oil tanks are grounded with a grounding rod and wire. Trucks are bonded to the tanks whenever a transfer of combustible or flammable liquids occur. Transfers are supervised such that the flow of liquids can be immediately stopped if a problem arises.

The site also uses 6 x 10,000 L and 4 x 20,000 L polyethylene, vertical tanks for wastewater and treated water. These are situated inside the Wastewater Treatment Building. Oily water is treated in the Cetco water treatment machine (See “Wastewater Treatment and Disposal”).

Wastes and Recyclables in Containers

Drums, totes, cylinders, pails, labpacks, and bins of hazardous and non-hazardous wastes and recyclables are received at the site for storage, transfer and/or processing. These materials come from commercial and industrial operations in and around the Winnipeg area as well as from other GFL locations and non-GFL generators in Manitoba and other provinces. Wastes received at the site include:

Class 2 – Compressed gasses (all subclasses)

Class 3 – Flammable Liquids (all subclasses)

Class 4 – Flammable solids (all subclasses)

Class 5.1 – Oxidizers

Class 5.2 – Organic peroxides

Class 6.1 – Toxic Substances

Class 8 – Corrosives (all subclasses)

Class 9 – Environmentally Hazardous Substances

The site does NOT accept or receive the following: Class 1 (explosives), Class 7 (radioactive materials), Class 6.2 (infectious substances), or materials regulated under the Canadian Nuclear Safety Board.

Some of these items come in as a straight liquid, solid, gas or a sludge, and some in another form such as used oil filters with residual oil, aerosol cans with residual liquid, lead-acid batteries, sorbent materials contaminated with oil or fuel liquids, etc.

A van truck collects wastes in containers and they are placed in the Shop for processing or in a trailer to be transferred for treatment or disposal elsewhere. Hazardous waste is sent to a hazardous waste disposal facility offsite. All containers are inspected for proper labels, damage and leaks when they are picked up and again after they are received at the Winnipeg site. Damaged containers or their contents are transferred into an undamaged drum or over-pack drum at the pickup point if in a condition unsuitable for transport. Spill clean-up materials are kept in drum storage areas.

The Shop has a containment curb so that the contents of a spilled or leaking drum are contained. Incompatible wastes and materials are segregated in different areas so that accidental mixing cannot occur. Compressed gas cylinders are kept outside and secured in an upright position.

Drums of oil, fuels, water, glycol and some non-chlorinated solvents are transferred into the bulk storage tanks for blending into alternate fuel.

Oil De-Ashing

Oil is de-ashed to meet the specifications of certain customers. The de-ashing process removes water and metals (ash). Oil to be de-ashed is put into tanks P1, P2 or P4 in the outdoor tank farm outside the south side of the main building. From here, the waste oil is transferred from one of P1, P2 or P4 into either P5 or P6 situated inside the Shop area of the main building. After transfer, the temperature of the waste oil is raised to approximately 60°C (140°F) by circulating it through a hot oil heater. Once at temperature, a diammonium phosphate (DAP) is mixed with hot water in a small tank and mixed. The dissolved DAP is added to the tank to be de-ashed (P5 or P6). This tank is then allowed to circulate for approximately 6 hours before it is sampled and the water content checked. Once the water content is less than or equal to 2%, the tank contents are allowed to cool to less than or equal to 104°C (220°F) before transferring to tank P7 or P8. The de-ashed oil is then left for least 24 hours to allow solids to settle out, after which the contents are pumped through a filter into P3.

After de-ashing, tanks P7 or P8 must be cleaned of the settled out solids (sludge) by transferring the solids over to the sludge tank within the processing building. When the sludge tank is full, this sludge will be transferred over to one of the sludge bins onsite for dewatering, stabilization and offsite disposal (See “Waste Sludge Processing” under the next section titled “Description of Proposed New Operations”).

Used Oil Filter Crushing

The site has an Oberg Model 300 used oil filter crusher for crushing used oil filters. First the drum tipper is loaded with a drum of filters and the contents are emptied out onto a sorting table. Here the contents are manually handled to remove foreign objects such as hard steel, paper filters, fuel filters, gloves, garbage, etc. which can damage the filter crusher. The sorted used oil filters are manually loaded into the filter crusher hopper and then it is activated. The metal of the crushed filters is ejected from the crusher as a “brick”. This brick is transferred to by conveyor to a lugger bin with a “false floor” or reservoir so that residual oil is allowed to drain from the bricks before being placed in a scrap metal bin

for recycling offsite. The residual oil is periodically drained from the reservoir and put into one of the storage tanks in the tank farm.

Used oil removed from used filters during crushing collects in a tote. The tote's liquid level is monitored by the crusher operator and when full, the contents are transferred over to a used oil tank for blending or de-ashing.

The filter crusher is located in the Shop area which has containment curb so that spilled or leaked oil from the crushing process is contained.

Empty metal drums that used filters came to the site in are washed in a Cuda®, single drum, washer for reuse if they are in good condition. Those in poor condition are sent for metal recycling.

Wastewater Treatment and Disposal (Cetco water treatment machine)

Wastewater processed in the Cetco Model CE-400 automatic water treatment machine includes all wastewater except for sanitary sewage and domestic wastewater. Precipitation falling onsite and outside containment areas is also not typically collected for treatment. The machine has an estimated maximum throughput of approximately 9000 L/h and is located in the Wastewater Treatment Building. The Cetco unit is inspected daily for leaks, sufficient consummables, general condition and general cleanliness.

The highest volumes of wastewater are treated April to October, during warmer weather. The Wastewater Treatment Building houses 11 tanks for clean and dirty water and the Cetco wastewater treatment unit. The treatment unit uses a bentonite clay-based flocculant (Referred to as "RM10") to concentrate oil and particles so they can be more thoroughly and easily filtered out. Eight (8) tanks are used to hold "dirty" water, two (2) tanks are for water polishing and one (1) tank holds "clean" water ready for disposal. The clean water is sent to the City of Winnipeg sewer system and the filtered solids (sludge) are put in a sludge bin onsite for offsite disposal.

A step-by-step illustrated process description is provided in Appendix C. There are 7 process steps:

1. Wastewater is pumped into the 1514 L treatment tank.
2. The treatment tank's 3 HP engine agitator runs as the flocculant is added from a bulk hopper.
3. The flocculant causes oil and particles to coalesce and fall out as sludge to the bottom of the treatment tank. This occurs during a short settling time.
4. Clear water is drawn from the top of the treatment tank and through a band filter to remove particles. The "cleaned" water goes to a filtrate tank.
5. Sludge at the bottom of the treatment tank is discharged to the band filter, trapping solids. Free water goes to the filtrate tank.
6. As solids build up on the band filter, it advances. The solids run through double rollers to squeeze out additional free liquid. Squeezed out sludge solids go into a dumpster.
7. Water in filtrate tank is pumped over to a polishing tank to allow for further settling out of any very fine particles. When the sludge bin is full its contents are dumped into a larger "sludge bin" for later disposal offsite.

Polished water is sent to the “clean water” tank for temporary storage prior to being transported to a City of Winnipeg storage tank. The City tests the water in the tank prior to sending it to the City sewer system for treatment.

Copies of the layout and elevation drawings for the Cetco unit, a complete copy of the Cetco CE-400 System Operation Manual and a copy of the GFL-WIN-OPS-001-F3 Winnipeg Cetco Daily Inspection Form are in Appendix D.

Note that water trucked to the city for disposal also includes domestic wastewater and sanitary sewage which may go separately or together with treated process waste water.

Aerosol Can Splitter

The site currently uses an AeroSolv® aerosol can puncturing device to remove residual liquids from used aerosol cans so that the metal containers can be safely recycled and the liquids bulked in drums for proper disposal. The aerosol cans received are primarily aerosol paint cans with residual paint. Aerosolv® is the only aerosol can recycling system that is verified by the United States Environmental Protection Agency and certified by the California EPA. The device is used by situating the puncturing device on an empty, closed top drum inside the larger bung hole. In the smaller bung hole, an air purifying filter is used to remove harmful vapours from air expelled out of the drum. The operator of the aerosol can splitter is required to wear an organic vapour filtering respirator while operating the device as a secondary precaution.

When the drum collecting liquids from the aerosol cans becomes full, the puncturing device and filter is removed from the bung holes and the drum bungs replaced. The drum is then labeled as UN1263 Paint Related Materials (Class 3) for hazardous waste disposal offsite. The filter is changed out as per the manufacturer’s recommendations.

A copy of the Aerosolv® operating manual is in Appendix E.

Description of Proposed New Operations

Direct Discharge to the City of Winnipeg Sanitary Sewage System

We are considering the installation of underground piping to tie into the City of Winnipeg sanitary sewer system. This would include two discharges into the sewer system: (1) process water treated in the Cetco unit, and (2) domestic wastewater including sanitary sewage. The process wastewater piping would come off a clean water tank (this will not necessarily be the same clean water tank as in current use in the Wastewater Treatment Building).

As per Section 47 of the City of Winnipeg Sewer By-Law No. 92/2010, the site will install an oil interceptor prior to the process wastewater discharge into the city’s sewer. The piping for domestic wastewater and sanitary will come off the main building. No oil interceptor will be installed for this line. A sample point will be installed so that the City of Winnipeg can obtain samples when they wish to check water quality.

The domestic and sanitary wastewater piping will be directly discharged into the City of Winnipeg sanitary sewer. The treated process wastewater will be batch discharged into the City of Winnipeg sanitary sewer.

Waste Sludge Processing

The following 2 options for waste sludge processing are being considered for the Winnipeg site and are currently undergoing feasibility review. At this time, we are only requesting approval of the concept of introducing sludge processing at the Winnipeg site. Prior to any actual construction of a sludge processing area, GFL will submit engineered drawings of the proposed design and a detailed description of the operation of the sludge processing area for review and approval.

The type of bulk liquid wastes with significant solids which will be accepted at the site would typically be coming from car wash pits, oil/water separator units, manholes, sumps, tank cleanings, and daylighting projects. Bulk liquefied waste containing solids, or “sludge”, would arrive from customers in vacuum trucks. Small quantities of material for processing may also arrive in drums, totes or other smaller means of containment. GFL-generated sludge from onsite wastewater processing in the Cetco treatment unit as well as material from onsite tank cleaning, sump cleaning, etc. would also be processed in the sludge processing area.

Sludge processed in the sludge processing area will be characterized either by a good knowledge of the originating process or operation, by an MSDS of the waste material, or by analytical results supplied by the customer. Considerations of employee safety, environmental license restrictions, the Winnipeg Sewer Bylaw, and applicable landfill criteria will be used to determine if the material will be accepted for treatment. Material meeting differing landfill criteria (i.e.: Class I vs. Class II), will be kept segregated in order to avoid cross contamination.

Option 1: Sludge processing in bins within an engineered containment pit:

Material to be processed will be offloaded or dumped into one of 2 shale bins located on the east side of the site (See Appendix F for a photo of a typical shale bin). The bins would be placed on containment which will be at a minimum an HDPE liner covered with gravel or sand. The containment area will either be sloped or have a curb to contain any spills. Vacuum trucks would be able to back into the bin to offload their contents and material in small means of containment would be transported to the bin for emptying. The dumped material for treatment will be contained by the three walls of the bin as well as a sloped containment curb at the entryway. The solids would be allowed to settle and free liquid would then be pumped off the top. This free liquid would be sent to the Wastewater Treatment Building for treatment prior to disposal (See “Wastewater Treatment and Disposal”). The remaining semi-solid sludge will then be mixed with wood chips and/or sawdust using a front end loader or skid steer to further stabilize it for landfill disposal. The dry material would then be sampled for physical and chemical analysis to characterize the composition of the waste as documented in the “Sludge Sampling and Analysis” section. The stabilized waste material will then be loaded into trucks for hauling to landfill.

The bins will be approximately 6.4 m (L) x 2.2 m (W) x 1.5 m (H) for a total capacity of approximately 21 m³/each, constructed of at least 5 mm thick steel plate. A Quonset hut, enclosed on three (3) sides will be used to house the wood chips/saw dust used to stabilize dewatered sludge. This structure will minimize any dust carryover from handling the woodchips/saw dust as well as protect it from the elements.

Two fire extinguishers will be located in the sludge processing area.

Option 2: Sludge processing pad

The proposed sludge mixing area or “pad” will have a maximum gross capacity of 180 m³ and would store no more than 144 m³ allowing for 36 m³ excess containment capacity or 125%. The pad will be separated into 3 cells each having a maximum gross capacity of 60 m³ and each would store no more than 48 m³.

At least 300 mm thick, 30 MPa compressive strength concrete will be used, complete with continuous PVC stops at all formed joints and an epoxy sealant. There will be minimum 25mm thick steel welded kick plating on vertical walls at the end of each bay. A minimum 150mm high concrete spill/splash entrance containment curb (like a “speed bump”) will be installed at the entrance to the pad. The pad itself will be sloped to promote fluid containment. The current plan is to have the pad heated by a heating fluid circulated through coils/piping in the cement and to be covered on three sides to protect it from the elements.

Sludge processing in the sludge pad will be virtually identical to that described previously for the sludge processing bins. Vacuum trucks would back up to one of the 3 cells that slope downward for offloading

There will be at least 2 fire extinguishers located at the sludge pad.

Inspections and Analyses

Sludge Sampling and Analysis

The vast majority of sludge processed at the Winnipeg site (~99%) will be non-hazardous and non-regulated waste, coming from construction and general industrial operations. Each load will be checked as previously described and segregated in one of the 2 bins or 3 cells of the pad based on its characteristics, prior to processing. The stabilized sludge will then be re-tested by a third party lab to determine appropriate management and disposal options. The stabilized sludge will be tested in accordance with US EPA Method 9095 Paint Filter Liquids Test, Test Methods for Evaluating Solid Wastes – Physical/ Chemical Methods (EPA Publication No. SW-846) to ensure it can be classified as a solid waste. A toxicity Characteristic Leachate Procedure (TCLP) scan, per US EPA Regulation CFR261, Method 1311, for Volatile Organic Carbons (VOCs), Polynuclear Aromatic Hydrocarbons (PAHs) and/or metals will also be completed to determine if the waste is non-hazardous, based on the nature of each batch of waste processed (i.e.: generator sources).

Once results are obtained, they will be reviewed by an Operations Manager and filed. If any parameter exceeds the chosen landfill's requirements, the load will be diverted to an alternative, appropriate disposal facility.

Wastewater Sampling and Analysis

The site holds Pollution Prevention Plan IWSB-PP-753 with the City of Winnipeg which requires meeting the water quality set out in Schedule B of the City of Winnipeg Sewer By-Law No. 92/2010.

The City of Winnipeg randomly takes a grab sample of the facility's wastewater after it has been trucked to their sewage treatment facility. These samples are tested against the water quality parameters in Schedule B of the City of Winnipeg Sewer By-Law No. 92/2010. If any parameter is exceeded, the City of Winnipeg may impose a surcharge (certain parameters only) or issue an "Order to Correct By-law Violation" requiring Pollution Prevention Planning documents. The last test was done February 26, 2016 whereby the City of Winnipeg confirmed the effluent to sewer meets by-law requirements. A copy of their letter and the results of their testing are in Appendix G.

After the installation of piping to discharge wastewater directly into the City of Winnipeg sanitary sewage system, the site will test each batch of treated process wastewater for pH, oil & grease, and volatile organic carbons (VOCs) prior to discharge as a spot check for problems.

Oil/Water Interceptor Inspections and Maintenance

The proposed oil separator will be installed, inspected and maintained as per the manufacturer's recommendations. A log of inspection and maintenance activities on the oil separator will be maintained for at least the previous 12 months as per clause 50(2) of the City of Winnipeg Sewer By-Law No. 92/2010.

Facility Inspections

Facility personnel complete a number of different inspections. The Facility Inspection is a general inspection of all areas including the overall property, the tank farms, and inside buildings. The Cetco wastewater treatment unit is inspected daily for leaks, damage, cleanliness and availability of consumables. Fire extinguishers are inspected monthly by site personnel to ensure they are properly mounted, not blocked and fully charged. A qualified fire safety contractor is used to perform annual inspections on fire extinguishers and inspections on any other fire equipment.

Groundwater Testing

Groundwater testing of 4 onsite wells has been done annually since 2013. The last testing event in 2015 identified exceedances of PHCs. GFL will be installing and sampling from 3 additional monitoring wells in 2016 in order to determine if there are any trends of concern. GFL intends to continue sampling and analyzing these wells (will total 7 wells after the 2016 sampling event) annually for conductivity, pH, temperature, DO, OVCs, PHCs, BTEX and VOCs using a laboratory with Canadian Association for Laboratory Accreditation (CALA).

Emergency Response to Incidents

GFL - Liquid Waste West has a Spill Prevention and Containment Procedure (GFL-EHS-COR-044-PR) that applies to all operations in Liquid Waste West. The procedure describes how operations must be run in order to prevent spills and leaks. The Winnipeg Emergency Response Procedure (GFL-WIN-OPS-001-PR) explains actions site personnel will take in the event of an emergency. Considered are onsite emergencies involving fire/explosion, spills, injury, flooding, tornado, a workplace violence situation and the need to evacuate. Offsite emergencies considered because of the potential impact to site operations or personnel working offsite (i.e.: drivers) include an offsite fire/explosion or gas release, flooding, tornados, and a workplace violence situation. The site reports environmental accidents as per the Manitoba Environmental Accident Reporting Regulation 439/87.

A copy of GFL-EHS-COR-044-PR Spill Prevention and Containment Procedure and GFL-WIN-OPS-001-PR Winnipeg Emergency Response Procedure are in Appendix H.

Training and Knowledge

Management Team

The Winnipeg facility has an Operations Manager and Facility Supervisor who both work from offices onsite along with an Office Manager. GFL Supervisors are required to complete a Leadership for Safety Excellence course through the Manitoba Construction Safety Association. The Operations Manager has approximately 18 years of experience and the Supervisor has 12 years of experience.

The major offsite support includes the General Manager (Edmonton) and Operations Managers at different locations across Western Canada, the Compliance Manager and Safety Administrator (Edmonton), and additional administrative staff (Edmonton). Other support functions exist in Edmonton and Toronto as well. The Edmonton office has developed Policies and Procedures for GFL - Liquid Waste West which provide guidance and direction on performing daily activities.

Employees

There are 10 drivers and 4 shop personnel working within the facility and 2 administrators working in the office. Employee turnover is very low and the experience level is high. Employees must follow Work Instructions developed by performing a hazard assessment of the task or job and incorporating preventative measures into the steps of that job. New employees undergo an orientation that covers basic safety and operational knowledge followed by further procedure review and on-the-job training. Once the new employee demonstrate competency in the tasks required of them, management allows them to work independently.

Copies of the Tables of Contents for GFL - Liquid Waste West and Site Policies, Procedures, Forms and Work Instructions are in Appendix I.

Consultants and Contractors

GFL employs qualified consultants to perform required environmental testing such as soil and water testing as well as Phase I or II ESAs.

Contractors performing inspections, maintenance or construction/demolition are selected based on their credentials and experience.

If you have any questions or require further information, please contact me via email or telephone (below).

Sincerely,

A handwritten signature in black ink, appearing to read 'N. J. Ruhl', written in a cursive style.

Nola Ruhl, P. Eng.
Compliance Manager
GFL Environmental Inc.
4208 – 84 Avenue
Edmonton, AB, T6B 3N5
Wk: 780-485-5000
Email: nruhl@gflenv.com

cc: Raj Rathamano, Manitoba Conservation
Jason Henkel, Manitoba Operations Manager
John Powell, General Manager

Appendix A: 2011, 2013 and 2016
Manitoba Supplementary Certificates of Registration



The Corporations Act/
Loi sur les corporations
APPLICATION FOR SUPPLEMENTARY CERTIFICATE OF REGISTRATION
DEMANDE DE CERTIFICAT SUPPLÉMENTAIRE D'ENREGISTREMENT

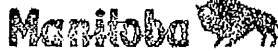

**SUPPLEMENTARY CERTIFICATE OF
REGISTRATION /
CERTIFICAT SUPPLÉMENTAIRE
D'ENREGISTREMENT**

Dated /
Fait le

04 APR AVR 2011

DIRECTOR/DIRECTEUR
The Corporations Act / Loi sur les corporations

1. Name of body corporate (after continuance, change of name or amalgamation)
Dénomination sociale (après la prorogation, le changement de dénomination ou la fusion)

GFL ENVIRONMENTAL WEST CORPORATION

2. Date of continuance, change of name or amalgamation
Date de la prorogation, du changement de dénomination ou de la fusion

March 28, 2011

3. Registered office address in current jurisdiction (include postal code) /
Adresse actuelle du bureau enregistré (inclure le code postal)

**219, 6203 28th Avenue
Edmonton, AB T6L 6K3**

**COMPLETE ONLY ITEM 4, 5, 6 OR 7
REPLIR UNIQUEMENT LA RUBRIQUE 4, 5, 6 OU 7**

4. CONTINUANCE / PROROGATION

- a) If change of name occurred, current name on record in Manitoba /
S'il y a eu un changement de dénomination, indiquer la dénomination actuelle au Manitoba
n/a
- b) Business number / Numéro d'entreprise
- c) New jurisdiction and governing statute / Nouvelles autorité législative et loi régissant la corporation

5. CHANGE OF NAME / CHANGEMENT DE DÉNOMINATION

- a) Current name in Manitoba / Dénomination sociale actuelle au Manitoba
ENVIRO WEST INC.
- b) Business number / Numéro d'entreprise
897240883

FORM 6 / FORMULE 6

6. AMALGAMATION / FUSION

- a) Jurisdiction of amalgamation / Autorité législative où la fusion a eu lieu
n/a
- b) Names of all amalgamating bodies corporate
Nom de toutes les personnes morales fusionnantes
- c) Business Number (for bodies corporate registered in Manitoba)
Numéro d'entreprise (pour les personnes morales enregistrées au Manitoba)
- d) Business Number of amalgamated corporation (if already assigned) / Numéro d'entreprise de la corporation issue de la fusion (s'il a déjà été attribué)

**7. CORRECTION OF ERROR IN PREVIOUS APPLICATION /
CORRECTION D'UNE ERREUR DANS UNE DEMANDE ANTÉRIEURE**

- a) Business number / Numéro d'entreprise
n/a
- b) Date of application being corrected / Date de la demande rectifiée
n/a
- c) Details / Détails
n/a

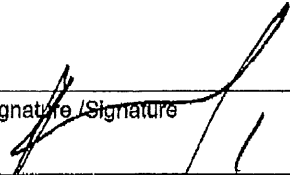
Date / Date March 31, 2011	Signature / Signature 	Office Held / Poste Vice-President
-------------------------------	--	---------------------------------------

FORM 8 / FORMULE 8

OFFICE USE ONLY / RÉSERVÉ À L'ADMINISTRATION Corporation Number / Numéro de la corporation 6286418
--

The Corporations Act
APPLICATION FOR SUPPLEMENTARY
CERTIFICATE OF REGISTRATION



SUPPLEMENTARY CERTIFICATE OF
REGISTRATION /
CERTIFICAT SUPPLEMENTAIRE
D'ENREGISTREMENT

Dated /
Fait le

15 JAN. / JAN 2013

DIRECTOR/DIRECTEUR
The Corporations Act (Loi sur les corporations)

1. Name of body corporate (after continuance, change of name or amalgamation)

GFL Environmental Inc.

2. Date of continuance, change of name or amalgamation

January 1, 2013

3. Registered office address in current jurisdiction (include postal code)

1070 Toy Avenue, Pickering, Ontario, Canada L1W 3P1

COMPLETE ONLY ITEM 4, 5, 6 OR 7

4. CONTINUANCE

(a) If change of name occurred, current name on record in Manitoba

(b) Business Number

(c) New jurisdiction and governing statute

5. CHANGE OF NAME

(a) Current name in Manitoba

(b) Business Number

6. AMALGAMATION

a) Jurisdiction of amalgamation

Ontario

b) Names of all amalgamating bodies corporate

c) Business Number
(for bodies corporate registered in Manitoba)

GFL Environmental East Corporation

841884893

GFL Environmental West Corporation

897240883

1886127 Ontario Ltd.

870139961

d) Business number of amalgamated corporation (if already assigned)

841884893

7. CORRECTION OF ERROR IN PREVIOUS APPLICATION

a) Business Number

b) Date of application being corrected

c) Details

Date January <u>2</u> , 2013	Signature 	Office held Patrick Dovigl - President
---------------------------------	--	---

OFFICE USE ONLY

Corporation Number: **6643508**

The Corporations Act
POWER OF ATTORNEY



Take notice that

OFL Environmental Inc.
(Name of appointing body corporate)

appoints

Brant D. Harvey

(Name of attorney in full)

2500 - 360 Main Street, Winnipeg, MB R3C 4H6

(Business address of the attorney including street number, municipality and postal code)

its attorney in Manitoba to accept service of or be served with process in any suit or proceeding against it in the province and to receive all lawful notices for it. It authorizes the attorney to perform all necessary acts relating to the matters within the scope of this power of attorney. It declares that, until notice of the appointment of the attorney's replacement has been filed with and accepted by the Director under *The Corporations Act*, service of process or a lawful notice on the attorney is legal and binding on it.

Date Jan 2 / 13	Signature 	Office held Patrick Dovigi - President
--------------------	---	---

CONSENT TO ACT AS ATTORNEY

I, Brant D. Harvey

(Name of attorney in full)

of

2500 - 360 Main Street, Winnipeg, MB R3C 4H6

(Business address, including street number, municipality, and postal code)

consent to act as the attorney for the appointing body corporate named above.

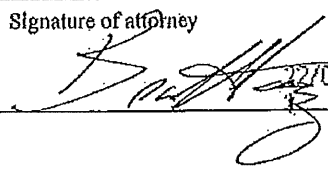
Date JAN / 14 / 2013	Signature of attorney 	Rc # B1240751157 F# 6643508 L# 3 Power of Attorney CORP PA 1 @ \$30.00 22/01/2013 11:24:06 AM ***REPRINT**
-------------------------	---	---

Business Number 841884893

FORM 8

OFFICE USE ONLY	6643508
Corporation Number	



Healthy Living, Seniors and Consumer Affairs
1010 - 405 Broadway, Winnipeg MB R3C 3L6
Téléphone (204) 945-2500, Fax (204) 945-1459
Toll Free in Manitoba 1-888-246-8353, E-Mail: companies@gov.mb.ca
Website: <http://www.companiesoffice.gov.mb.ca>



Vie saine, Aînés et Consommation
405, Broadway, Bureau 1010, Winnipeg (Manitoba) R3C 3L6
Téléphone (204) 945-2500, Télécopieur (204) 945-1459
Interurbains sans frais au Manitoba : 1-888-246-8353
Adresse électronique : companies@gov.mb.ca
Site Web : <http://www.companiesoffice.gov.mb.ca/index.fr.html>

2013/01/22

GFL ENVIRONMENTAL INC.
PITBLADO LLP
2500-360 MAIN ST
WINNIPEG, MB, R3C 4H6

Re: GFL ENVIRONMENTAL INC.
BN/NE 84188 4893 MC 0002
(our file number/Notre numéro de dossier:6643508)

When you registered your company with the Companies Office, you already had a Business Number (BN). We have obtained an account identifier for your new registration. You may use this number whenever you need to contact us. Your BN is:

Lorsque vous avez enregistré votre entreprise auprès de l'Office des compagnies, vous aviez déjà un numéro d'entreprise (NE). Nous avons obtenu un identificateur de compte pour votre nouvel enregistrement. Vous pouvez utiliser ce numéro chaque fois que vous avez besoin de communiquer avec nous. Vos coordonnées sont les suivantes :

Business Number (BN)	Account Identifier
84188 4893	MC 0002

Numéro d'entreprise (NE)	Identificateur de compte
84188 4893	MC 0002

As you know, the first nine digits of the BN are unique to either the registrants of your business name or to your corporation. It stays the same regardless of how many or what type of government accounts you add to it. The two letters in the Account Identifier represent the program area, in this case, Manitoba Companies Office. The last four digits identify the account number within that program area.

Comme vous le savez, les neuf premiers chiffres du NE sont réservés exclusivement aux personnes qui ont enregistré votre nom commercial ou à votre corporation. Le NE demeure le même, quel que soit le nombre ou le genre de comptes gouvernementaux que vous lui ajoutez. Les deux lettres de l'identificateur de compte représentent le secteur de programmes, soit, dans le cas présent, l'Office des compagnies du Manitoba. Les quatre derniers chiffres indiquent le numéro de compte dans le secteur de programmes en question.

If you have any questions regarding this matter, please call us at (204) 945-2500 or toll free at 1-888-246-8353. You may also visit the One Business-One Number website at <http://www.gov.mb.ca/finance/onebn/>.

Si vous avez des questions au sujet des renseignements ci-dessus, veuillez composer le (204) 945-2500 ou le 1 888 256-8353 (appels sans frais). Vous pouvez aussi visiter le site Web " Une entreprise, un numéro " à l'adresse www.gov.mb.ca/finance/onebn/index.fr.html.

ONE BUSINESS/ONE NUMBER
Simplifying your dealings with
Government!

UNE ENTREPRISE, UN NUMÉRO
Simplifiez vos relations avec le
gouvernement!

The Corporations Act
APPLICATION FOR SUPPLEMENTARY
CERTIFICATE OF REGISTRATION



SUPPLEMENTARY CERTIFICATE OF
REGISTRATION /
CERTIFICAT SUPPLÉMENTAIRE
D'ENREGISTREMENT

06 JAN JAN 2016

Dated /
Fait le

M. [Signature]

DIRECTOR/DIRECTEUR
The Corporations Act /Loi sur les corporations

1. Name of body corporate (after continuance, change of name or amalgamation)

GFL Environmental Inc.

2. Date of continuance, change of name or amalgamation

January 1, 2016

3. Registered office address in current jurisdiction (include postal code)

40 King Street West, Suite 5002
Toronto, Ontario M5H 3Y2

COMPLETE ONLY ITEM 4, 5, 6 OR 7.

4. CONTINUANCE

(a) If change of name occurred, current name on record in Manitoba

(b) Business Number

(c) New jurisdiction and governing statute

5. CHANGE OF NAME

(a) Current name in Manitoba

(b) Business Number

6. AMALGAMATION

a) Jurisdiction of amalgamation

Ontario

b) Names of all amalgamating bodies corporate

c) Business Number
(for bodies corporate registered in Manitoba)

GFL Environmental Inc.
At Your Disposal Environmental Ltd.
Ever Green Ecological Services Inc.

841884893

GFL Environmental Solid Waste Inc.
M&R Environmental Ltd.
Sani Smart Waste Disposal Services Inc.

GFL Investments Ltd.

d) Business number of amalgamated corporation (if already assigned)

7. CORRECTION OF ERROR IN PREVIOUS APPLICATION

a) Business Number

b) Date of application being corrected

c) Details

Date
January 4, 2016

Signature

Office held
Patrick Dovigi - President

OFFICE USE ONLY

Corporation Number:

7267372

Form 6

Appendix B: Site Layouts

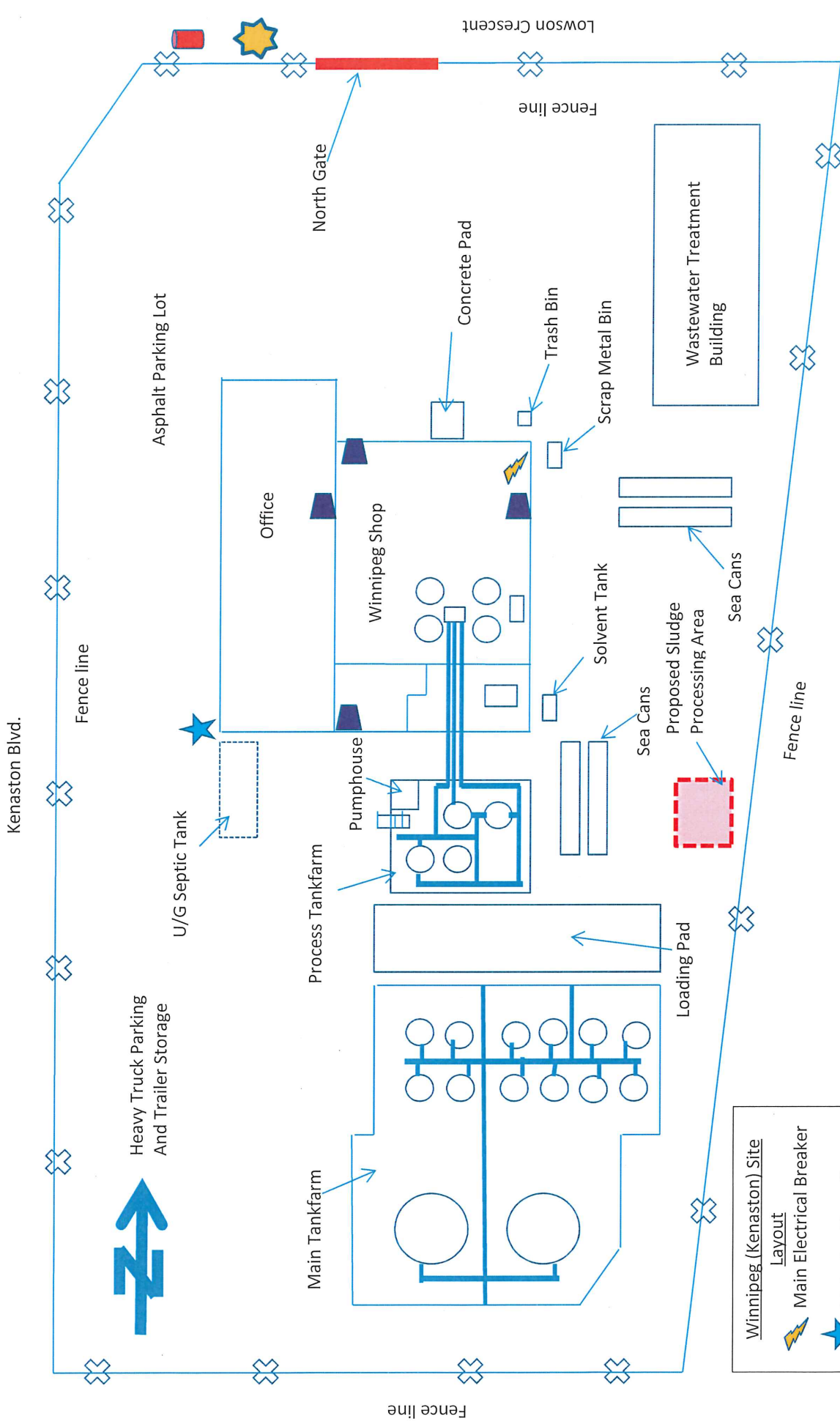

Overview of Winnipeg (Kenaston) Site Layout
 (See details in Main Tank Farm, Process Tank Farm, Winnipeg Shop and Office Layouts – not all details are shown here)

Winnipeg (Kenaston) Site Layout

- Main Electrical Breaker
- Main Gas Shutoff
- Muster Points
- Fire Hydrant & Valve
- Audible alarms

Hardcopies of this document are uncontrolled and may be assumed current only at the time of printing.

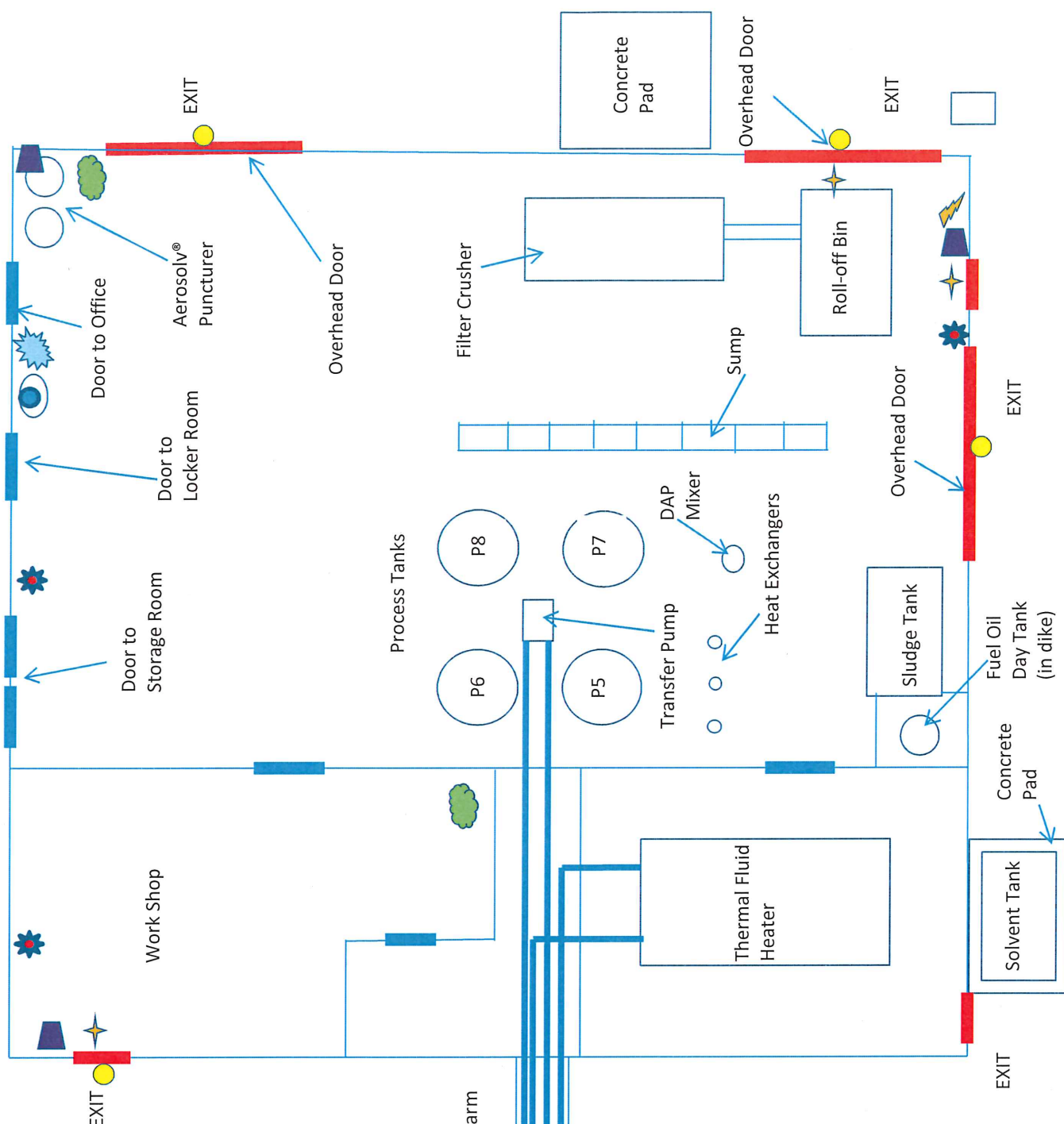

Pipe chase to Process Tank Farm

Winnipeg (Kenaston) Shop Layout



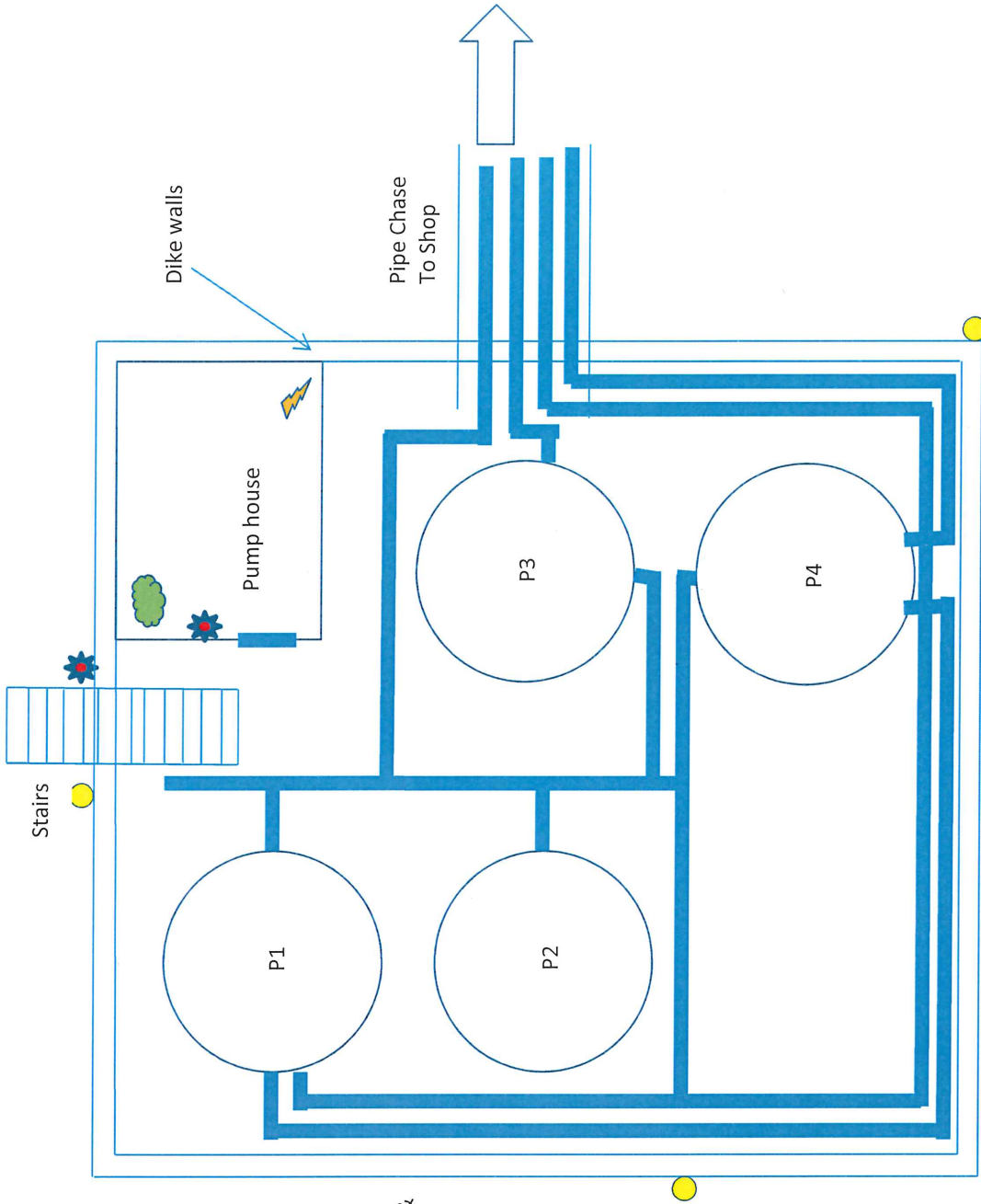

- Electrical panels
- Fire extinguisher
- Outdoor Light
- Eyewash station
- Emergency shower
- Muster Point
- Spill Cleanup Materials
- Audible alarms
- Emergency Light

Hardcopies of this document are uncontrolled and may be assumed current only at the time of printing.



Truck Loading Area & Main Tankfarm



Winnipeg (Kenaston) Process Tankfarm Layout

-  Electrical panel
-  Fire extinguisher
-  Outdoor light
-  Spill Cleanup Materials

Sea Can (steel container)

Hardcopies of this document are uncontrolled and may be assumed current only at the time of printing.

Winnipeg (Kenaston) Main Tankfarm

-  Fire extinguisher
-  Light standard
-  Spill Cleanup Materials

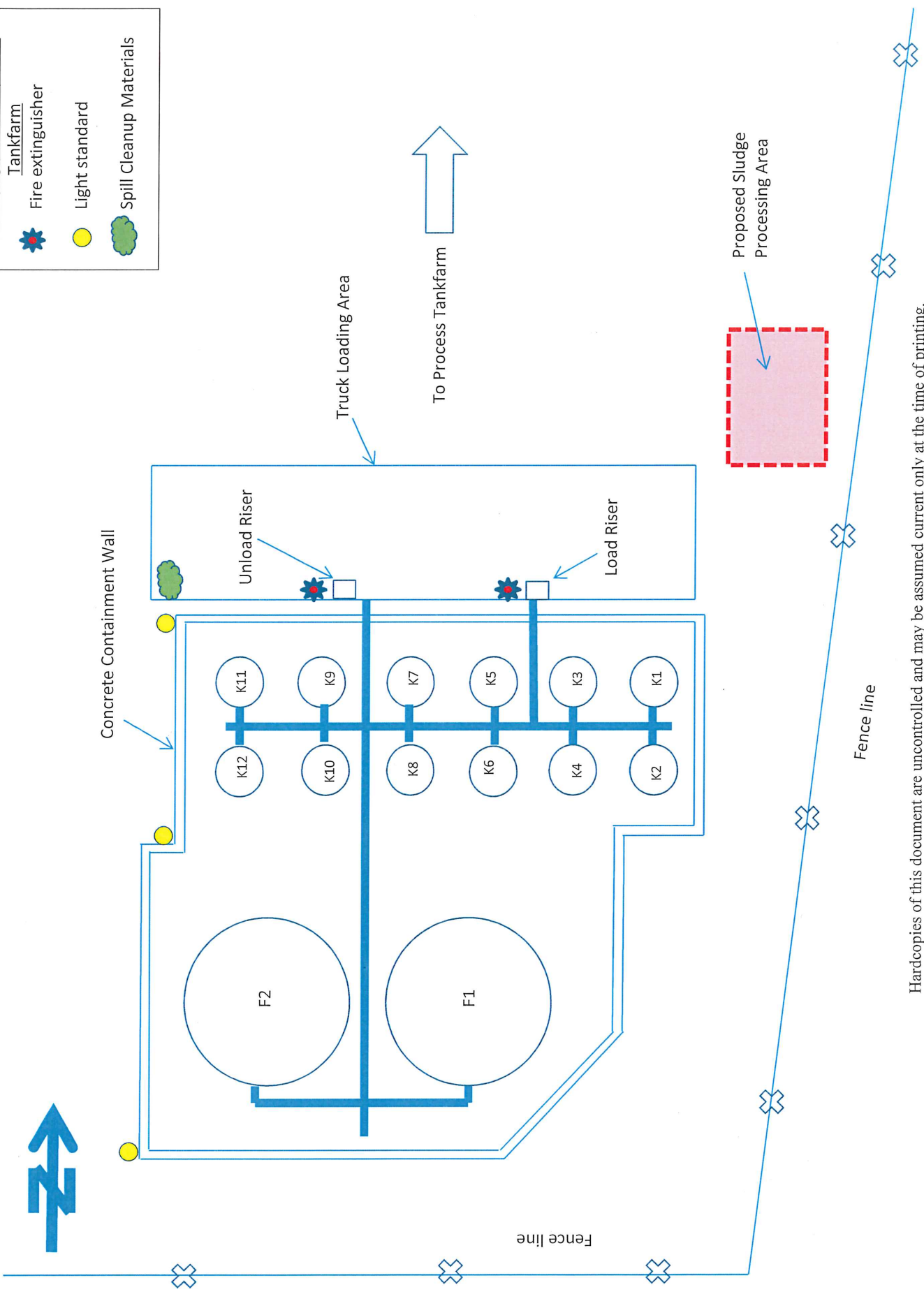

Hardcopies of this document are uncontrolled and may be assumed current only at the time of printing.



Winnipeg (Kenaston) Office Building

- Electrical panel
- Fire extinguisher
- First Aid Kit
- Spill Cleanup Materials
- Audible alarms
- Emergency Lighting

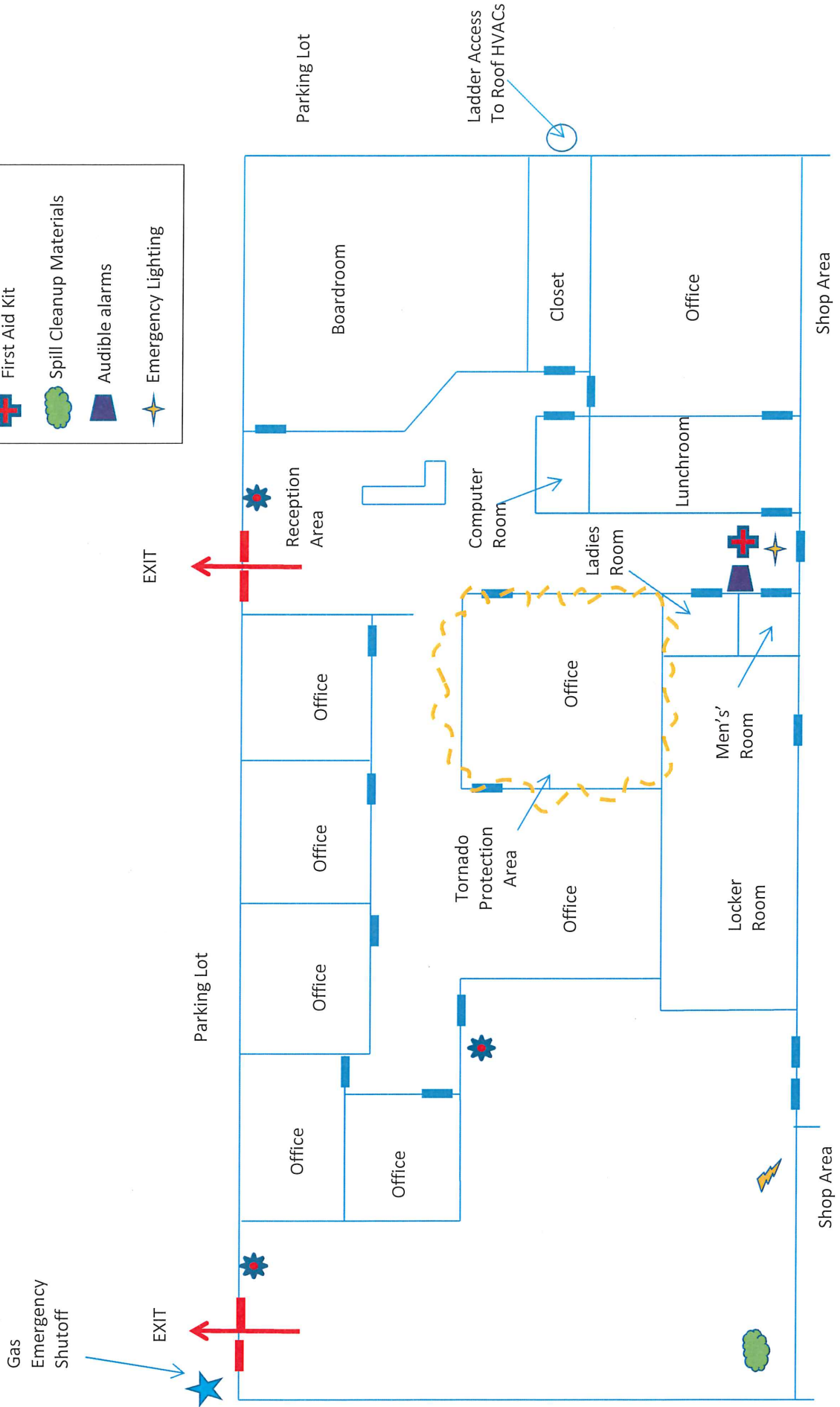

Hardcopies of this document are uncontrolled and may be assumed current only at the time of printing.

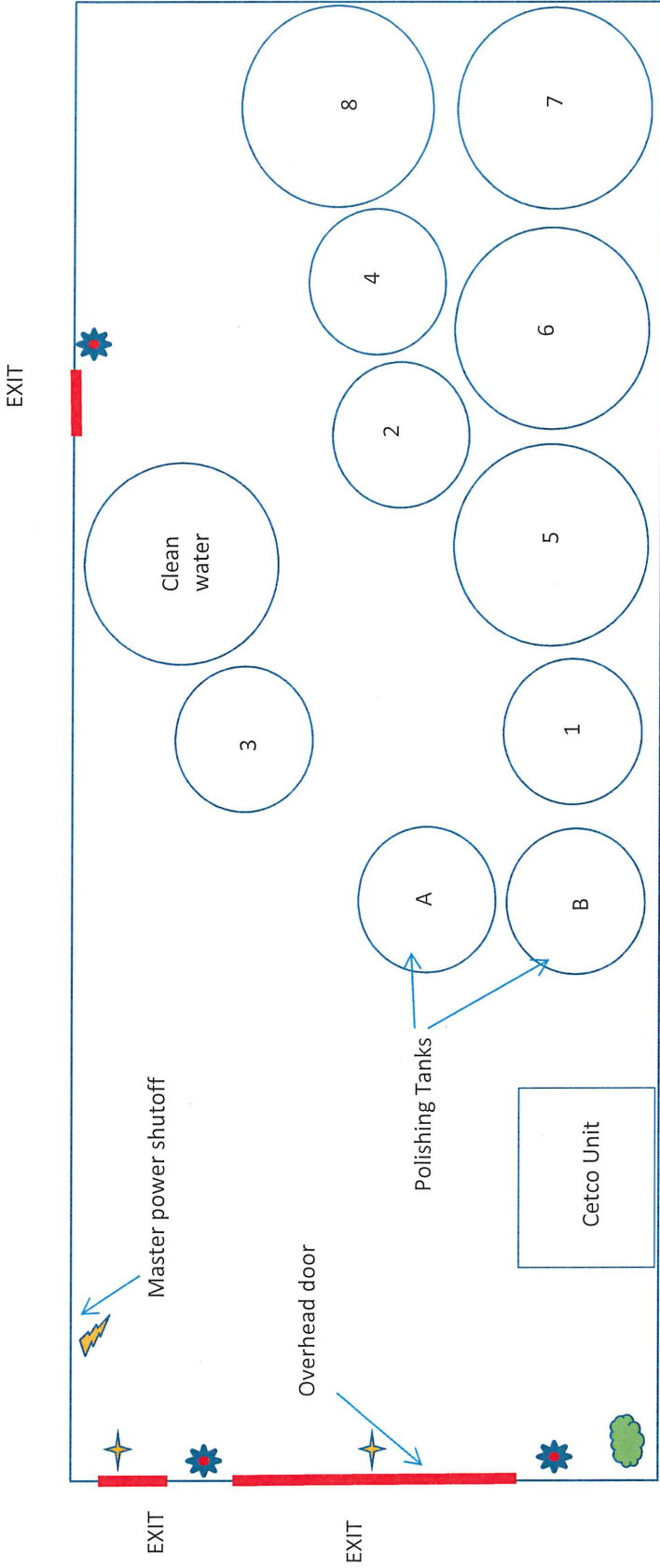

- Winnipeg (Kenaston) Wastewater Treatment Building
- Electrical panel
- Fire extinguisher
- Spill Cleanup Materials
- Emergency Lighting

NOTE: Tanks 1 through 8 are dirty water tanks



Appendix C: Illustrated Process Description of Wastewater Treatment Unit

THE PROCESS



All of Ringwood Environmental's bandfilter systems provide treatment solutions with simple, minimal operation. The following diagrams outline the operation of a CE system, although all our bandfilter systems work on the same basic principles. Click through the steps to see how the process works.

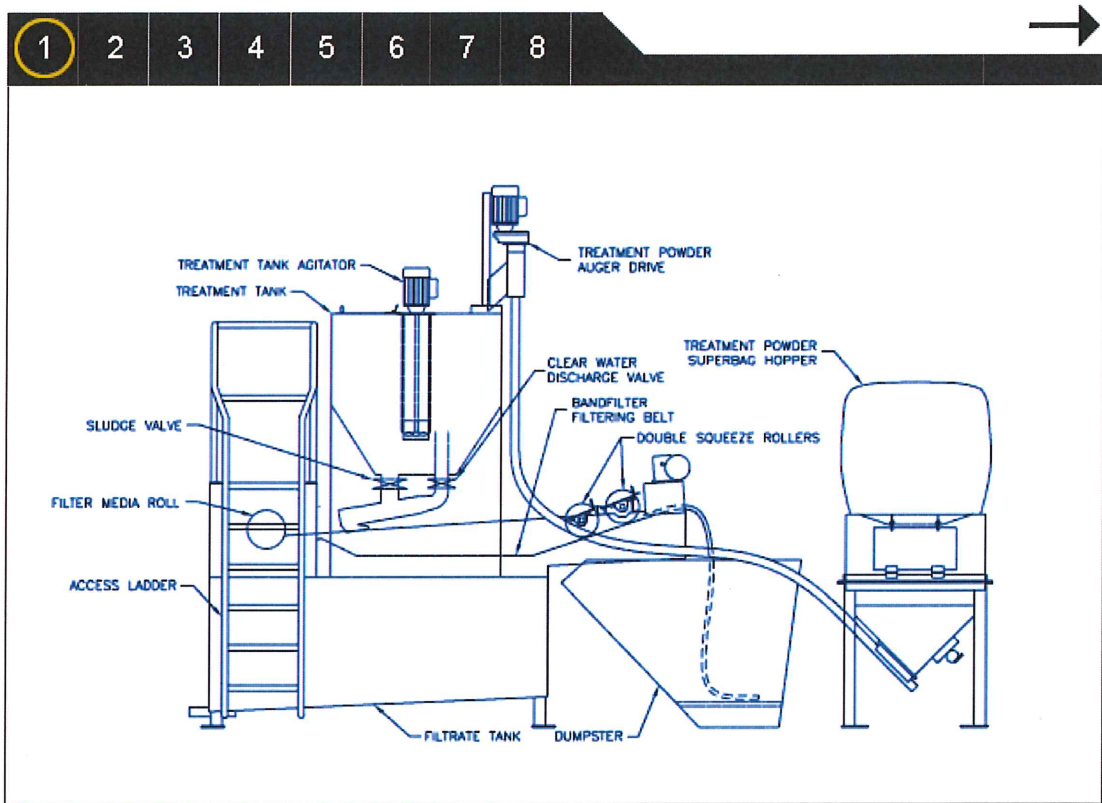

THE PROCESS



Wastewater is pumped to the system until the treatment tank is filled.

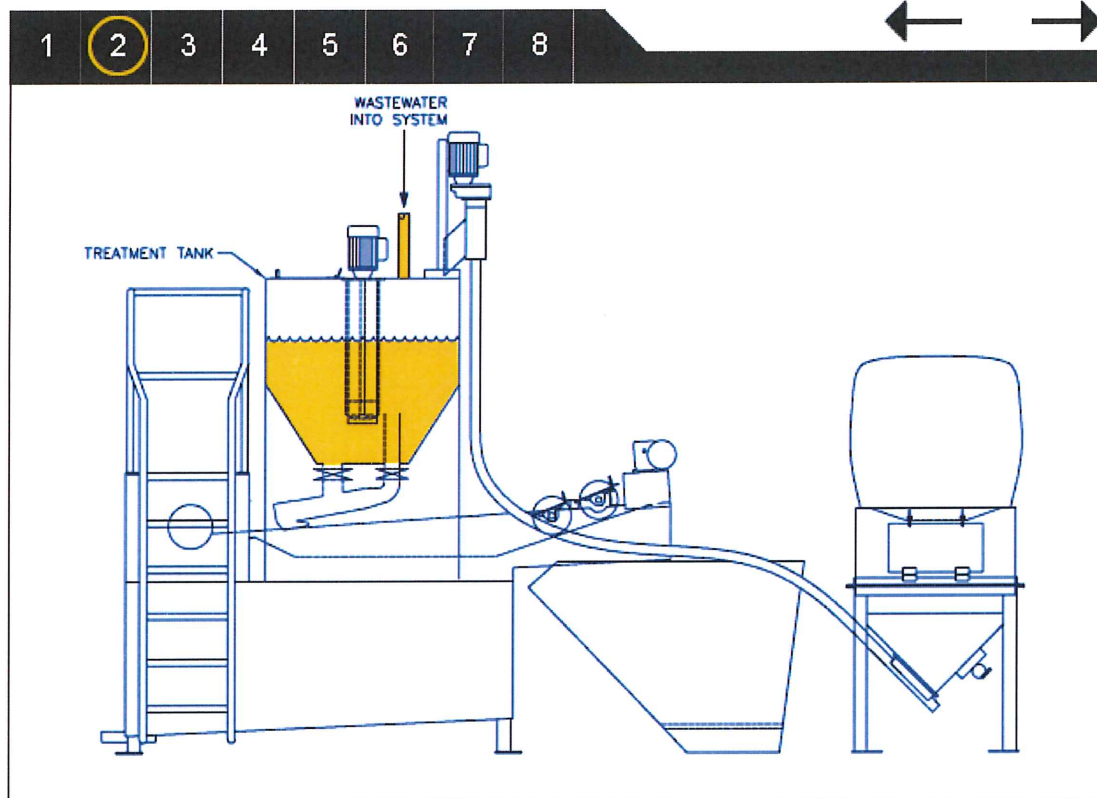

THE PROCESS



The treatment tank agitator runs as the treatment powder is added. After a short mix time, the agitator stops.

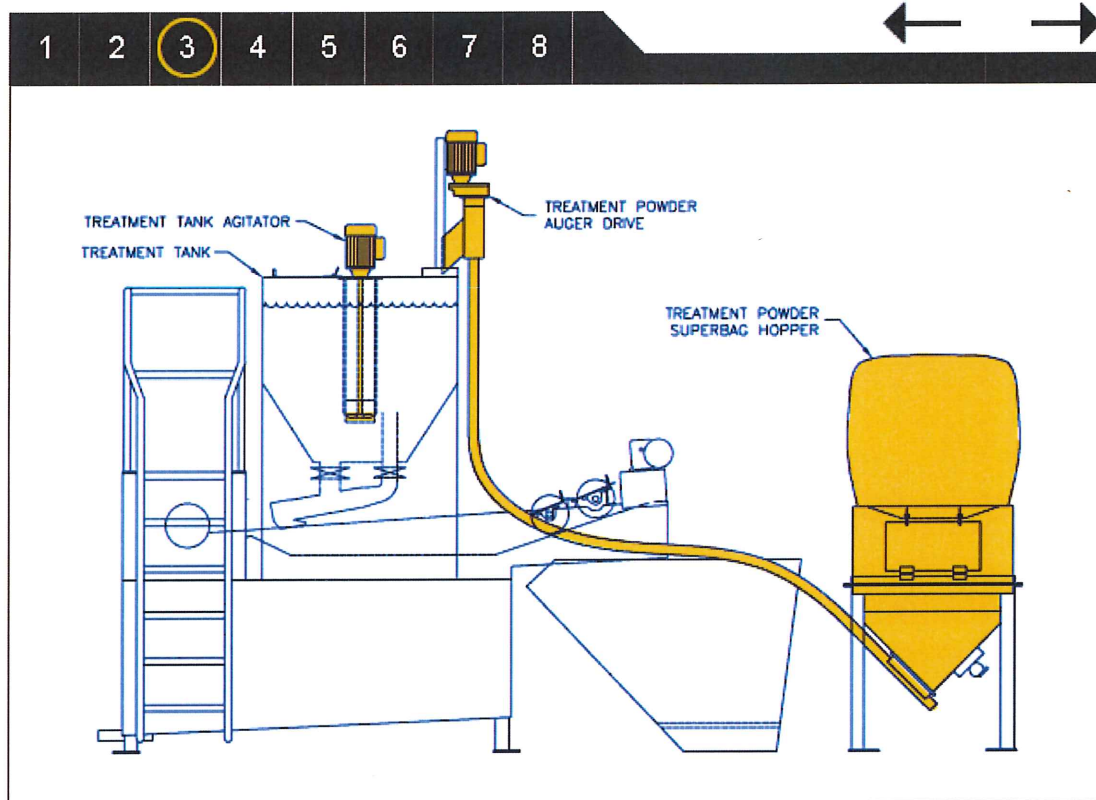

THE PROCESS



Large flocs are produced in the treatment tank during treatment, and the resulting sludge quickly settles to the bottom.

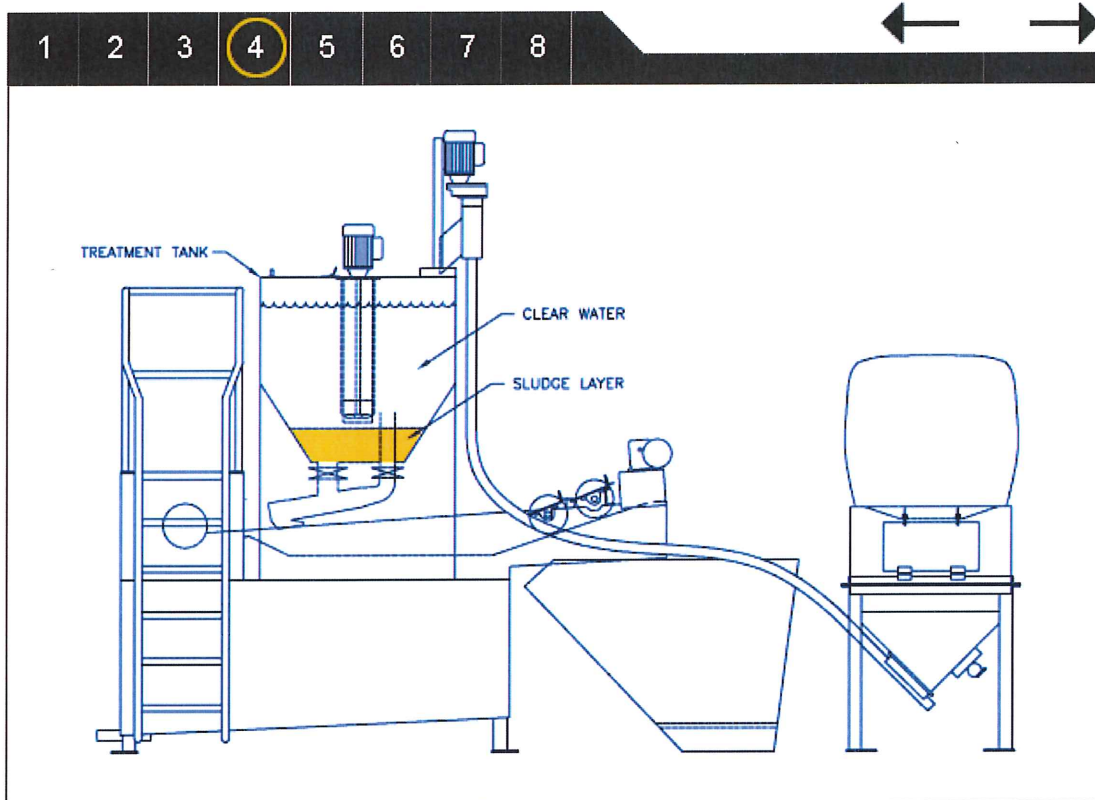

THE PROCESS



After the short settling time, the clear water is drawn from the top of the tank first, greatly speeding up the process time. This water flows onto the bandfilter. The disposable filter media traps unsettled floc particles as the water flows through and into the filtrate tank.

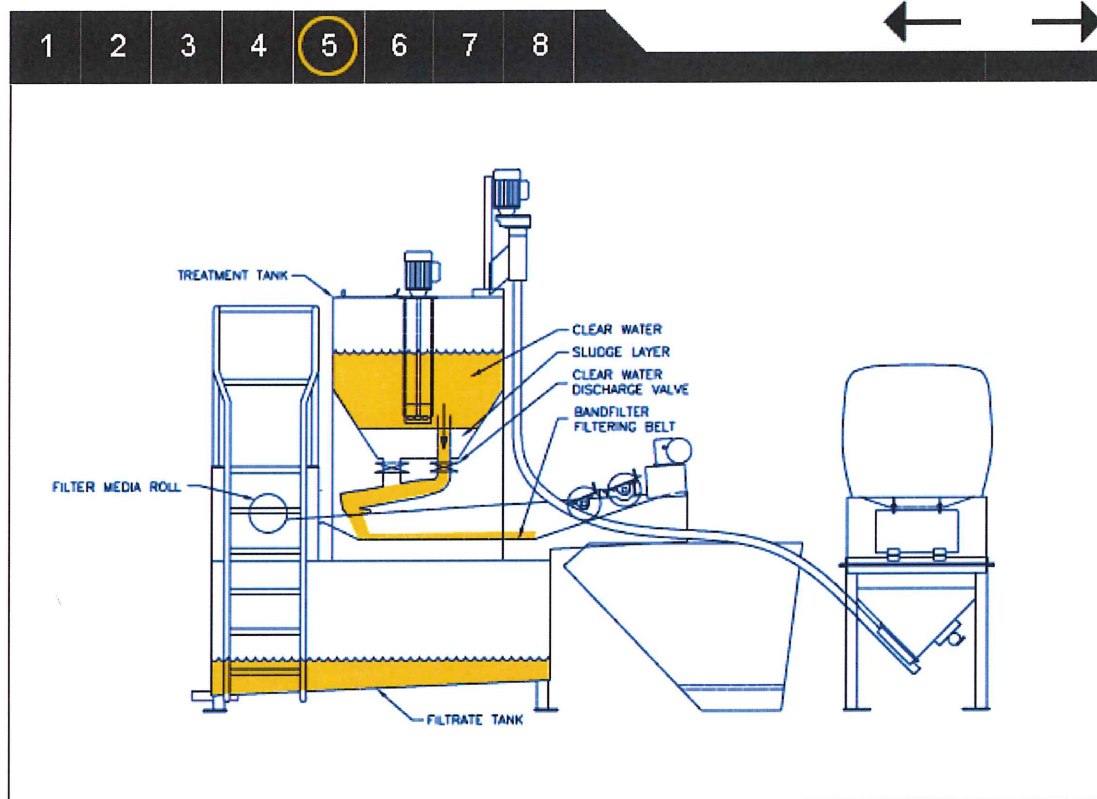

THE PROCESS



The sludge is now discharged onto the bandfilter. The filter media traps the sludge and allows the clean, treated water to pass through and into the filtrate tank.

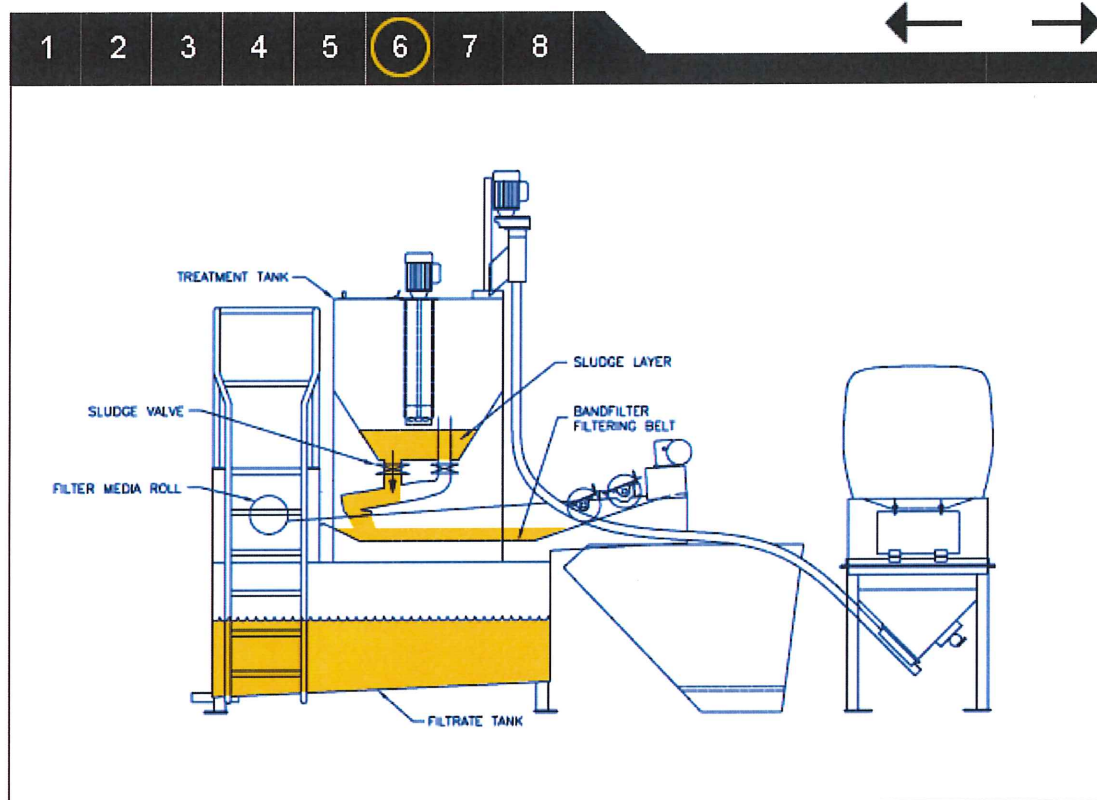

THE PROCESS



As the sludge builds up on the bandfilter, it advances and transfers the sludge to the dumpster. The sludge passes through the double rollers, which squeeze out more water.

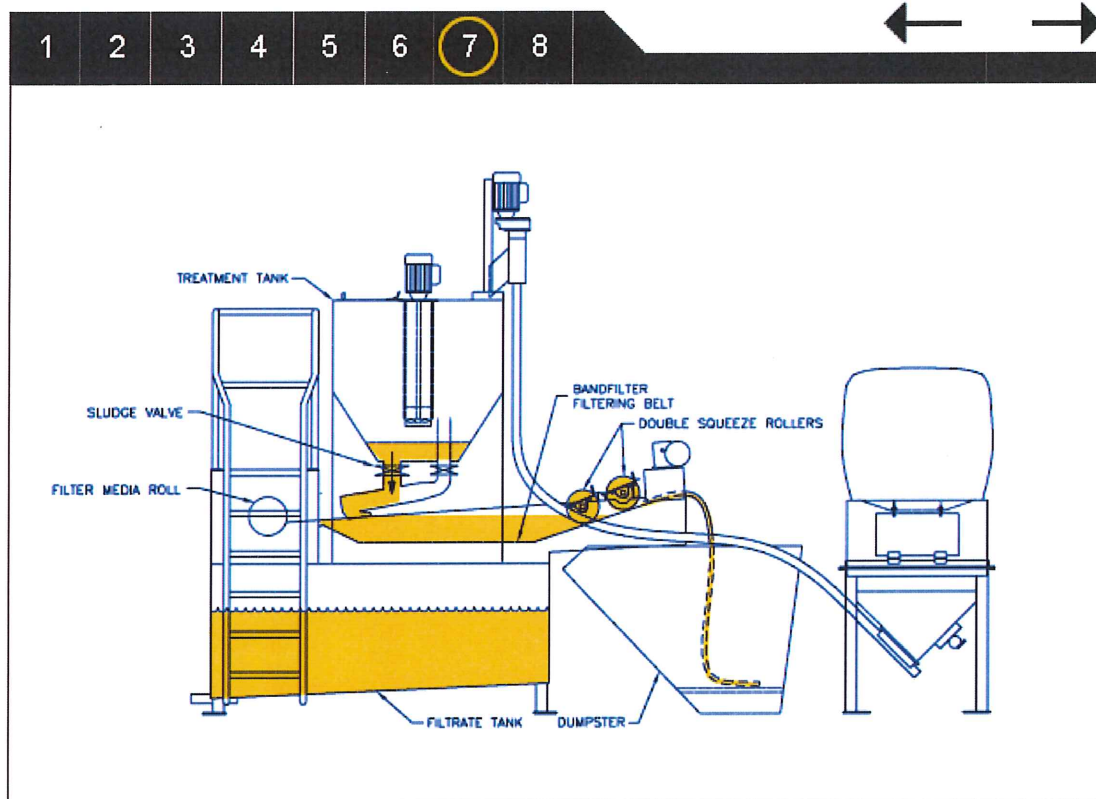

THE PROCESS



When all sludge has been dewatered, the treated water in the filtrate tank is pumped out.

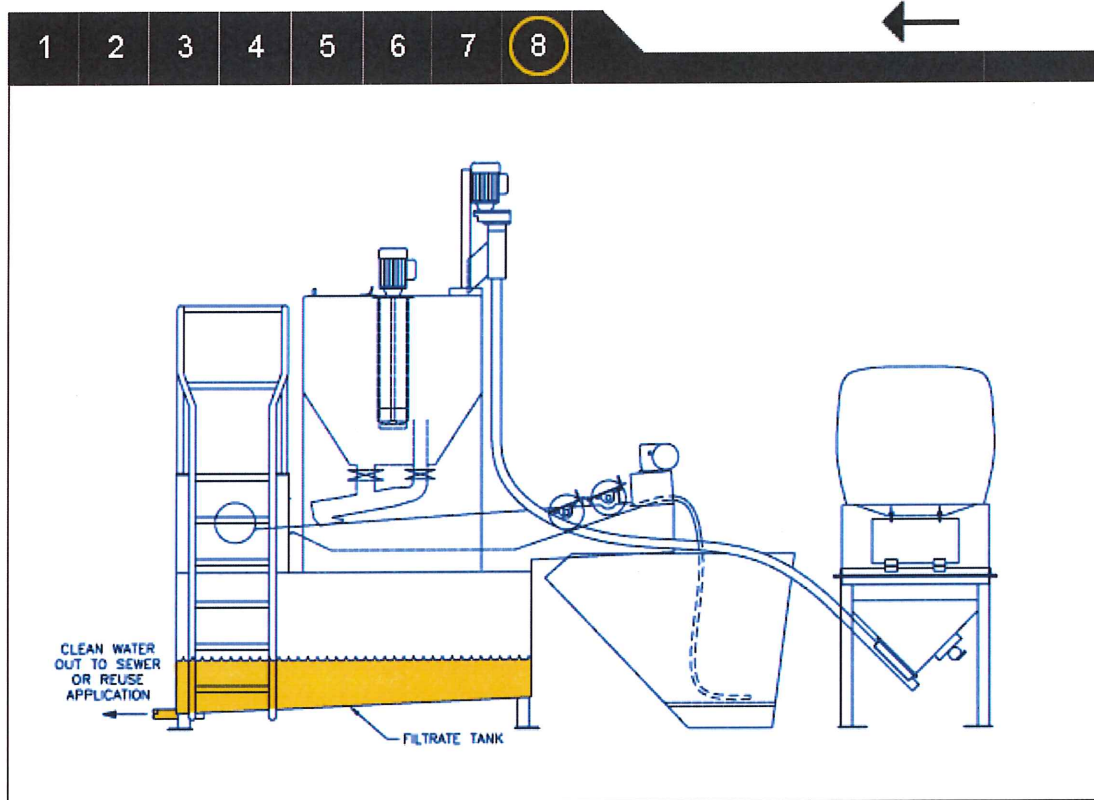

Appendix D: Layout and Elevation Drawings & System Operation Manual
for the Cetco Wastewater Treatment Unit

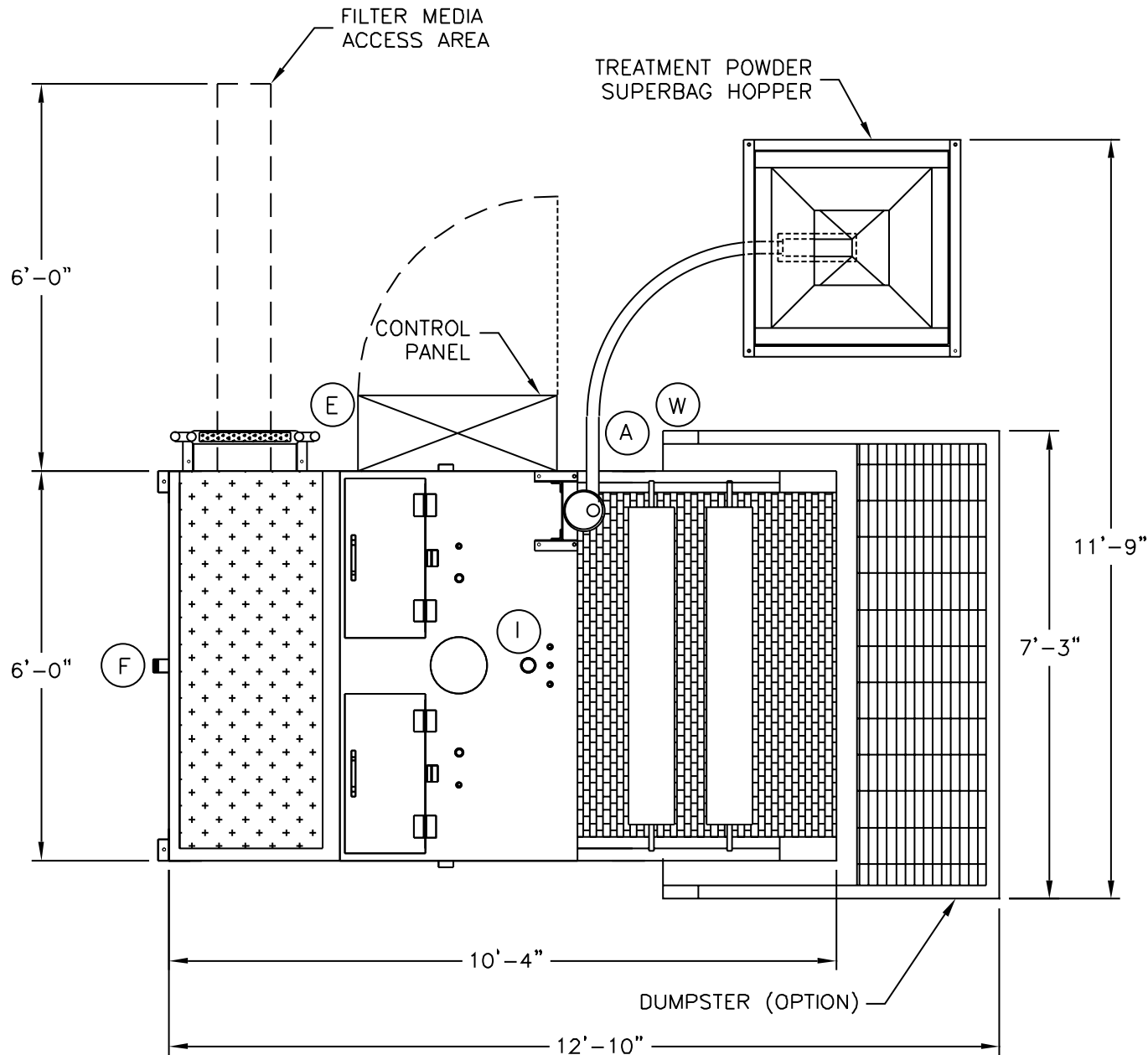

SERVICE REQUIREMENTS

- (E) 480 VAC, 30 AMP, GROUNDED, 3 PHASE POWER TERMINATED AT THE DISCONNECT IN THE CONTROL PANEL.
- (A) 1" FNPT AIR SUPPLY CONNECTION. 80-100 PSI, CLEAN, DRY, AIR REQUIRED, WITH LOCKING HANDLE VALVE ON SERVICE LINE.
- (W) 1" FNPT CITY WATER SUPPLY CONNECTION. 30 PSI REQUIRED, WITH LOCKING HANDLE VALVE ON SERVICE LINE.
- (I) 2" FNPT INFLUENT WATER INLET CONNECTION.
- (F) 2" MNPT EFFLUENT WATER DISCHARGE CONNECTION.

CE 400
LAYOUT DRAWING

NOTE:
CONTROL PANEL, HOPPER, & LADDER
CAN BE LOCATED ON EITHER SIDE
OF THE CE 400.

SERVICE REQUIREMENTS

- (A) 1" FNPT AIR SUPPLY CONNECTION. 80-100 PSI, CLEAN, DRY, AIR REQUIRED, WITH LOCKING HANDLE VALVE ON SERVICE LINE.
- (E) 480 VAC, 30 AMP, GROUNDED, 3 PHASE POWER TERMINATED AT THE DISCONNECT IN THE CONTROL PANEL.

- (W) 1" FNPT CITY WATER SUPPLY CONNECTION. 30 PSI REQUIRED, WITH LOCKING HANDLE VALVE ON SERVICE LINE.
- (I) 2" FNPT INFLUENT WATER INLET CONNECTION.
- (F) 2" MNPT EFFLUENT WATER DISCHARGE CONNECTION.

NOTE:
CONTROL PANEL, HOPPER, & LADDER CAN BE LOCATED ON EITHER SIDE OF THE CE 400. (CONTROL PANEL NOT SHOWN FOR CLARITY)

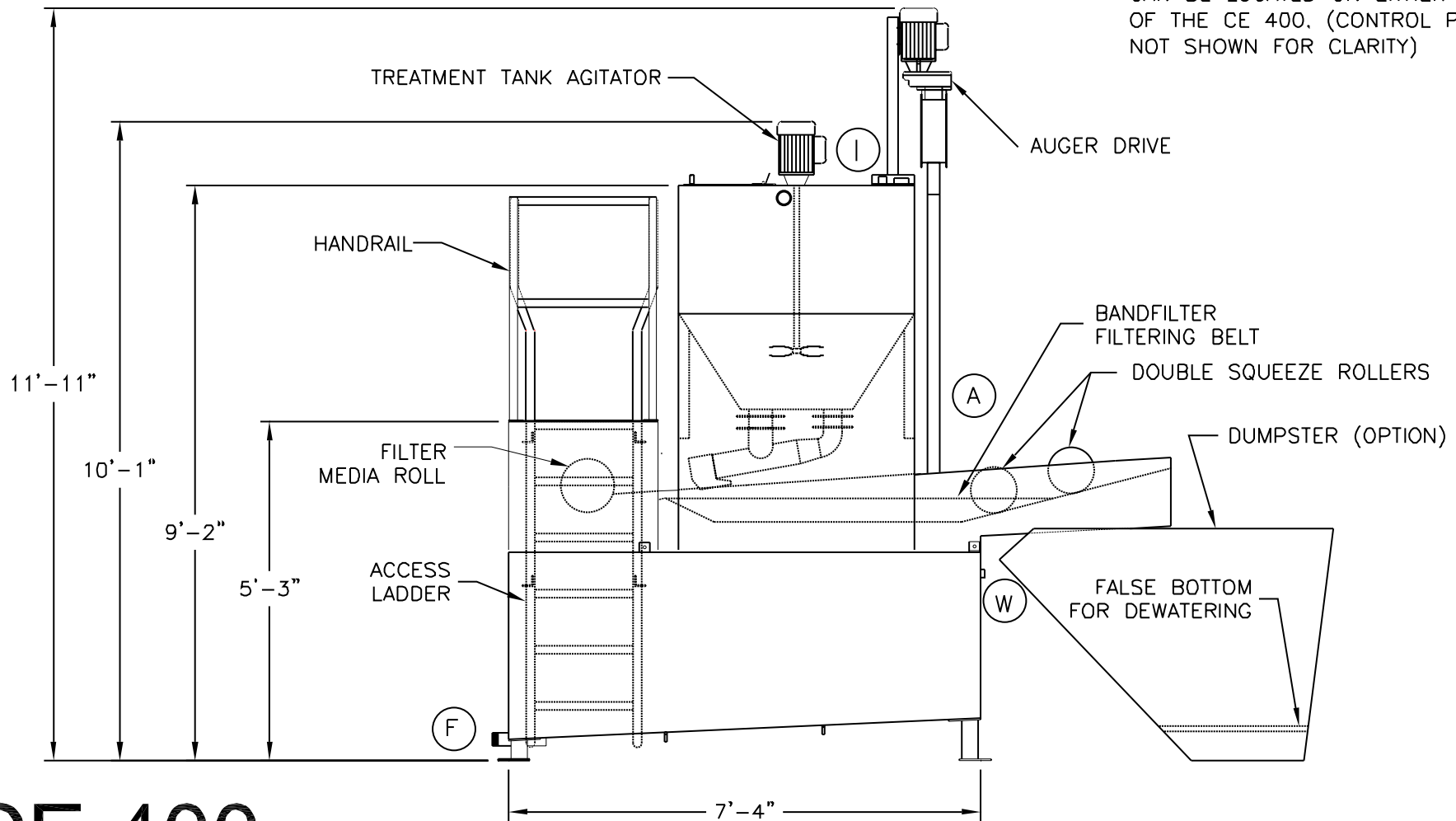

CE 400
ELEVATION DRAWING

CE MODEL WASTEWATER TREATMENT AND FILTRATION SYSTEM OPERATION MANUAL

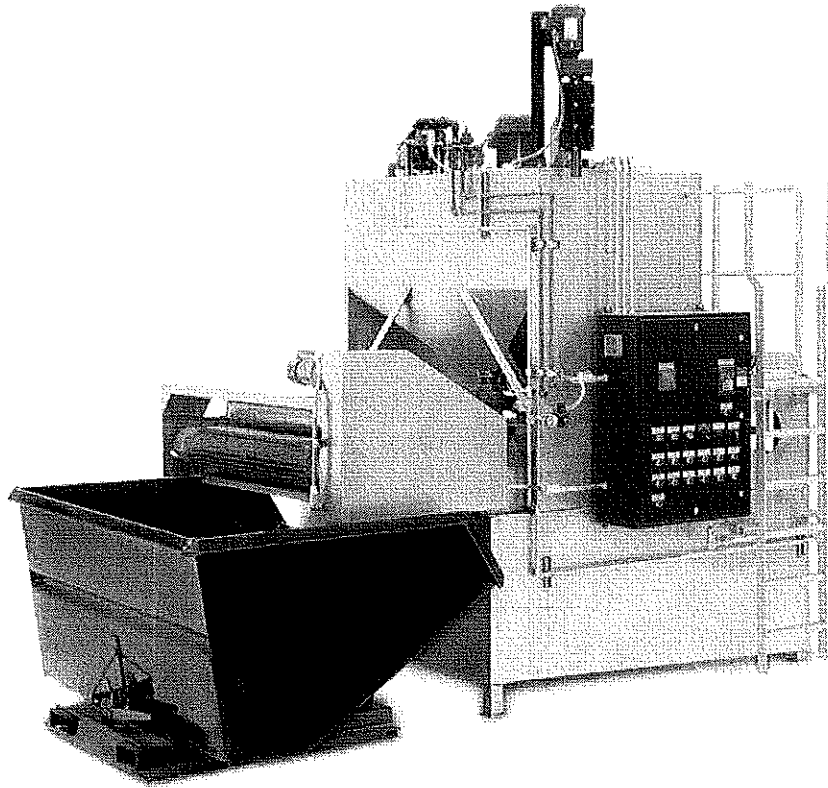

 **Ringwood**
Environmental, Inc.

6715 W. 73rd Street
Bedford Park, IL 60638
866-462-3826

www.ringwoodenvironmental.com

CE System

Table of Contents

Introduction

Wastewater Treatment Basics
Process and Equipment Overview

Operation

Manual Operation Step Descriptions
System Controls
Sequence of Operation
Changing Equipment Automatic Operation
Formula Editing

Maintenance

Alarm Descriptions and Troubleshooting Guide
pH Probe Calibration Procedure
Maintenance Schedule and Procedures
Filter Media Roll Change Operation

Appendix

Spare Parts List
Drawings
Vendor Literature

WASTEWATER TREATMENT BASICS

CHEMICAL TERMS

A. pH

pH is a measurement of the acidic or basic intensity of a liquid or other substance. A pH may range from 0 - 14, where 0 is acidic and 14 is basic. A measurement of 7 is generally regarded as neutral. Sometimes it is necessary to adjust the pH of the wastewater during treatment.

B. Acid

Acid is used to lower the pH of the wastewater, either before or after treatment. It is a corrosive substance and is composed of hydrogen plus one or more other elements. In the presence of certain solvents or water, it reacts with the production of hydrogen ions. An acid reacts with an alkali to form a salt and water.

C. Base (Alkali)

Base is used to raise the pH of the wastewater, either before or after treatment. It is a corrosive substance, which has the ability to neutralize an acid and form a salt. Caustic soda (sodium hydroxide) is the most common.

D. Colloids

Very small, finely divided solids (particles that do not dissolve) that remain dispersed in a liquid due to their small size and electrical charge.

E. Flocculation

The process of gathering fine particles together to form larger particles (flocs). Flocculation is based on bridging compounds that form chemically bonded links between colloidal particles to form floc networks.

F. Polymers

Greek for "many parts", polymers are giant molecules with wide ranging molecular weights. Polymers are both inorganic and organic in nature. The synthetic polymers which we utilize in wastewater treatment are generally plastics. These long chain polymers are used to aid in the bonding of floc networks.

G. Treatment Powder

This combination of specially treated silica (sodium bentonite clay), polymers, and additives, it is used to separate contaminants in wastewater and encapsulate the contaminants within the clay platelets.

H. BOD

Biological Oxygen Demand - The rate at which biological organisms (bacteria) utilize the oxygen during an organic decomposing process. In decomposition, organic matter serves as food for the bacteria.

I. COD

Chemical Oxygen Demand - The amount of oxygen consumed from a chemical oxidant during a specific test. Measured in mg/L or PPM.

J. Chelation

Term applied to a reacting agent that envelops a species such as a metal ion. Chelating agents make the breakdown and separation process in wastewater treatment very difficult. Ammonia and EDTA are two of the most common and stable agents.

TREATMENT CONCEPTS

The following narrative gives some important concepts that are associated with wastewater treatment. The terms listed below are used in both the narrative and everyday wastewater treatment and should be duly noted.

- The Waste Stream
- EQ / Hold / Spikes
- pH Adjustment
- Coagulants / Flocculants
- Lime / Polymer
- Polishing

In your application, the beginning factor that we look for is consistency. All **waste streams** are often piped to an equalization tank. The capacity of this tank allows for a good measure of equalization, which will give us the best chance for a day in and day out consistency. This capacity and equalization allows us to more effectively handle **spikes** in the waste stream, which could upset our pre-set treatment values.

We will possibly **adjust the pH** of the waste stream in the treatment tank to a lower value than that which is delivered. pH control can be a great tool when problem

batches arrive at the treatment system. Treating within a known pH range will allow for consistent results.

Many treatment schemes utilize **coagulants** as a preliminary treatment step. These low pH chemicals tend to break down the various compounds, which will allow for better separation. Addition of **flocculants** aid in the separation process. These flocculants are generally in the form of polymers, which help to tie up the contaminants, which have been partially separated by the preliminary coagulant process. Conventional wastewater treatment utilizes a "**lime-polymer**" process whereby the waste stream is shocked via a low pH (2-3), then treated with a polymer to aid in the separation, and lastly, hit with a lime slurry, which raises the pH and binds the overall process. This process is popular due to its economical components. The three-step process is sometimes performed in varying sequences.

Wastewater treatment is not an exact science.

We must remember that our waste stream is changing daily with regard to solids loading and concentrations of chemicals that find their way into the stream through unknown means. There are generally several points of entry within a facility where co-workers who don't consider the consequences to the treatment system operator can introduce problems. Ammonia, soaps, solvents, oils, and other chemicals found within a normal facility will greatly affect the treatability of any waste stream.

TREATMENT CHEMICALS

The most common treatment powder is a sodium bentonite clay based flocculant. It was originally designed to offer a one-step type of treatment targeted at removing heavy metals and oils.

Some of the industrial waste streams that utilize this modern form of wastewater treatment include:

- Aerospace Industry
- Ink & Paint Manufacturers
- Tanneries
- Truck & Tanker Wash
- Pulp & Paper Industry
- Food Processing Industry
- Plating Industry
- Automotive Manufacturers
- Agricultural Formulators
- Oil & Gas Industry

The success of the clay technology is due in part to the wide range of encapsulating properties that are associated with the product. It also has the ability to be formulated for specific applications.

HOW THE TREATMENT POWDER WORKS

The treatment powder is formulated to work through a sequence of reactions when wetted. The sequence is controlled by the solubility rates of the components.

1. The dry acid solublizes and reduces the pH in the wastewater to a point where the emulsion breaks.
2. As the oils break out of the emulsion, they are attracted to the cationic polymer. The cationic polymer, once fully wetted, is attracting all anionic charged molecules onto itself.
3. The calcium hydroxide solublizes next causing the pH to increase and precipitate metals, which are immediately attached onto the negatively charged bentonite clay.
4. The clay, being a negative charge, is ultimately attracted to the cationic polymer laden with oils and suspended solids. This attraction forms a fixated cocoon around the cationic polymer. This final reaction explains how we end up with a non-leachable sludge cake.
5. The clay complex forms flocs and settles out of the water with all contaminates permanently locked up in the clay complex.
6. The advantage of this chemistry is that the equipment can run faster, automatically, and provide a non-leachable (and non-hazardous) sludge.

RECORD KEEPING

Keep a log sheet:

- To dispute municipalities claims of discharge permit violations.
- To assist in troubleshooting environmental dilemmas in the facility.
- For assistance in issuance of permits required by regulators.

Log Sheets

- Log sheets should be kept by operators to help give a more defined picture of the treatment process.
- A well-kept log sheet will provide the best tool in troubleshooting the process.
- Log sheets will plot trends and histories.
- Financial aspects of the treatment process can be tracked.

Log sheets should include some of the following but not be limited to:

- Batch Number: Each batch should be assigned a number, for future tracking.
- Date / Time: The date / time the batch treatment was started.
- Initials: The initials of the person performing the treatment procedures.
- Starting pH: The starting pH of each batch should be recorded.
- Amount of chemicals used: For treatment history.

- Comments: Can include characteristics of the batch before and after treatment, treatment problems, etc.

Analytical records

Analytical records should be matched to log sheets to more definitively plot histories and trends of your treatment process.

System maintenance records

All system components should be placed under the same preventative maintenance program as other plant equipment.

pH Probe calibration

Records should be kept each time the pH system is calibrated. A number of organizations will require this for ISO and other certification programs.

PROCESS AND EQUIPMENT OVERVIEW

To fully understand the overall operation of the system and the role of the individual parts, this section describes the treatment process and the function of the equipment as it relates to the treatment process.

Treatment of wastewater is inherently a batch process. The CE system treats water automatically and continuously. Since the system operates on small volumes, one after another, in effect, it can be considered continuous.

There are four major parts to any wastewater treatment process. The influent water (or raw wastewater) must be stored while waiting for treatment. Then the water is treated. Following treatment, the sludge must be separated from the treated water. And finally, the treated water must be discharged or stored for reuse. These four parts of the process and how the equipment performs them are described below.

Equalization Tank (Option)

This is where the influent water is stored. The purpose of the equalization tank is to receive the various waste streams from throughout the plant and maintain the water such that the solid content and pH of the water is homogenous and consistent. Typically, it is desirable to store at least three times the treatment batch size to ensure consistency. Related components of the equalization tank are:

Agitator – Provides the mixing action in the equalization tank. The agitator runs occasionally on a timed cycle. It also runs for a few minutes prior to starting a treatment batch.

Overfill Level Probe – Provides an alarm that the equalization tank has reached its capacity. This can also be used to turn off the feed pumps that transfer wastewater to the equalization tank.

Batch Start Level Probe – Provides a signal to the control system indicating there is enough wastewater in the equalization tank to start a treatment batch. This level should be at least three times the holding capacity of the treatment tank for a consistent treatment process. This probe also prevents the equalization tank agitator from running when the water level is low, eliminating the potential for damage to the agitator.

Influent Transfer Pump – This pump transfers the influent water from the equalization tank to the treatment tank.

Treatment Tank

This is the upper tank on the CE system unit. It is the heart of the system where the actual treatment takes place. The influent transfer pump delivers wastewater from the equalization tank to this tank. Once the tank is full, several different operations can be performed to treat the water. The associated components and equipment and their functions are as follows:

Agitator – The agitator mixes in the chemicals, facilitating treatment.

Treatment Powder Hopper and Auger – Powdered clay-based flocculant is the primary chemical used in the treatment process. It is delivered to the treatment tank via a flexible auger from a super bag hopper and is mixed in and allowed to react with the wastewater, encapsulating the solids. Running time and dosages are pre-set according to the formula, and controlled automatically during each treatment cycle. A low-level probe on the hopper alerts the operator when the hopper is low. The hopper holds a 2000-pound bulk bag that is set on top using a forklift. After the bulk bag is set on top, the side door on the hopper is opened, and the operator reaches in to untie the duffel bag outlet on the bottom of the bag.

Fill and Overfill Probes – The fill probe provides a signal to the control system that the treatment tank is full and treatment can begin. The overfill probe provides an alarm that the tank has been filled to capacity.

Bandfilter

Following treatment, large, visible pieces of floc are present, which can be easily removed, leaving clear, treated water. The process of removing the floc is called dewatering. After the water is treated in the treatment tank, the floc is allowed to settle to the bottom of the tank. The clear water on top can be drawn off first, to speed up the dewatering process. Then the sludge (floc) is dumped. All the water and sludge passes through the bandfilter where the sludge is filtered out and the clear water passes through. The following devices are involved in the process.

Clear Water Valve – This valve is located on the bottom of the treatment tank with a standpipe inside the treatment tank. The standpipe is long enough to extend above the sludge layer. After settling, the clear water valve opens to allow the effluent water to drain onto the bandfilter.

Sludge Discharge Valve – This valve is located on the bottom of the treatment tank and opens to allow the sludge to dump onto the bandfilter.

Bandfilter – The bandfilter captures the sludge as it is dumped from treatment tank and allows the water to drain from the sludge through the filter media. The sludge and used filter media is conveyed to a dumpster. An adjustable speed motor drives the bandfilter.

Float Switch – This device turns on the bandfilter when the sludge on the bandfilter reaches a certain thickness. This provides clean filter paper for more sludge to discharge from the treatment tank.

Filter Media Roll and Media Sensor – A roll of filter media is stored and unrolls as needed by the bandfilter. The media sensor is a photo-switch that sounds an alarm when the media roll is empty.

Squeeze Roll – As the sludge and filter media advances down the bandfilter, this roller squeezes the water out of the sludge before the filter media falls into the dumpster.

Effluent Tank

The effluent tank is the lower tank on the CE system and is used to contain the effluent water that passes through the bandfilter during dewatering. This water is ready for discharge to the municipal sewer system or it can be stored for reuse. Related components of the effluent tank are:

Effluent Transfer Pump – This pump transfers the effluent (treated) water from the effluent tank to the reuse tank or municipal sewer system.

Level Probe – This probe is activated by the water level in the effluent tank and controls the discharge from the tank.

This section of the manual described the overall treatment process and a general overview of the equipment involved. The next section describes the treatment process in more detail by providing the step-by-step operations necessary to treat a batch manually.

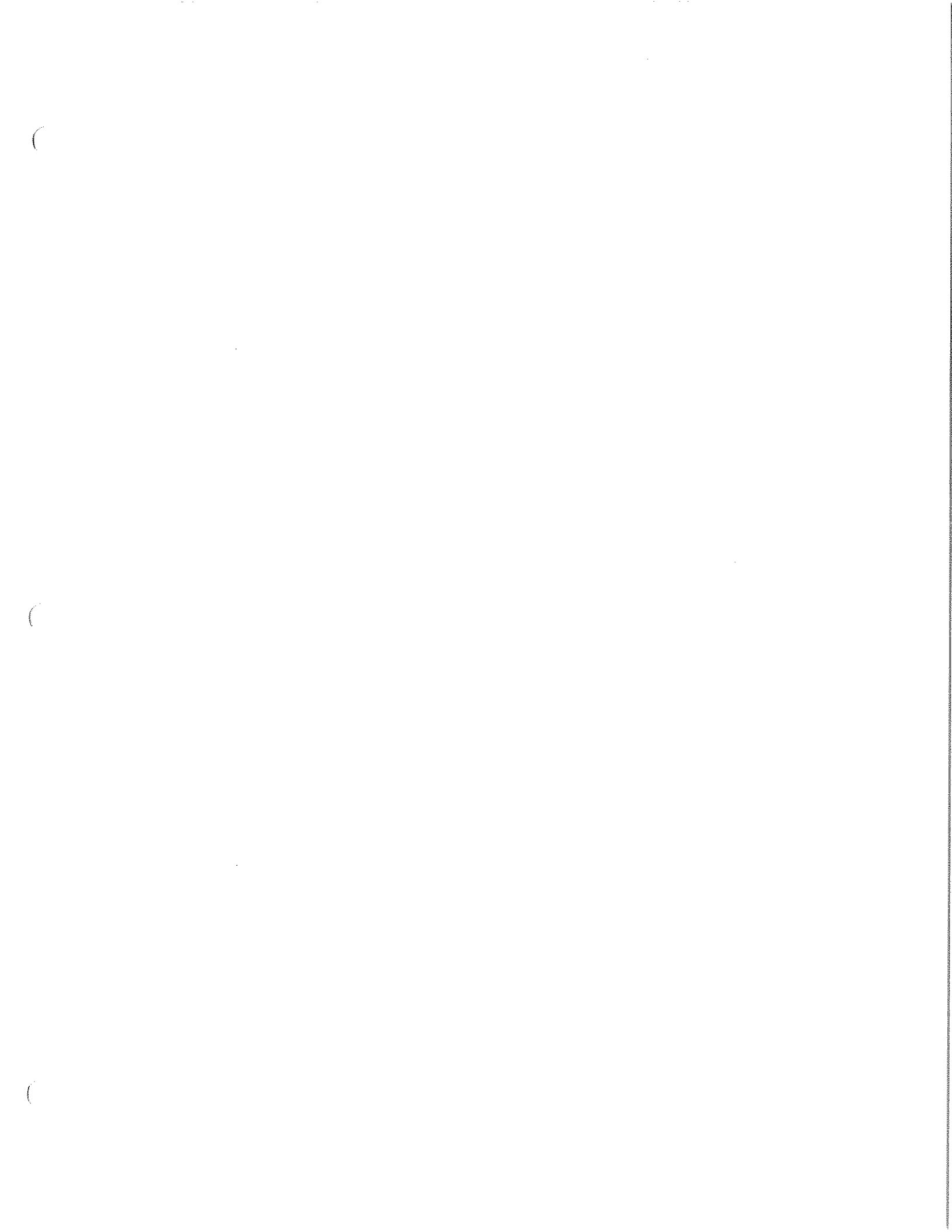

MANUAL OPERATION STEP DESCRIPTIONS

1. Make sure that the treatment tank is empty, there is RM-10 in the hopper and that there is enough water to treat a batch.
2. Turn on the equalization tank agitator (if available) for a few minutes to ensure that any particles in the water are dispersed evenly.
3. Turn on the influent transfer pump to transfer water to the treatment tank. Continue to run the equalization tank agitator during transfer as long as the water level in the equalization tank is above the propeller. If it drops below this point, turn off the agitator.

CAUTION: *Do not run the agitator if the water level in the tank is not above the propeller. Damage to the agitator can result.*

4. When the treatment tank is full, turn off the influent transfer pump. Also, turn off the equalization tank agitator if it is still on.

Once the treatment tank is full, it is time to begin treatment. The sequence of steps varies from system to system and is defined in the Equipment Setup list. Refer to the Equipment Setup listing for your system's sequence of operation. Regardless of the sequence, the following descriptions identify what the operator needs to do in each step when treating manually:

LOWERING THE pH (ACID ADDITION) – MANUAL (OPTIONAL)

1. Turn on the treatment tank agitator.
2. Turn on the pH recirculation pump. This circulates water from the treatment tank across the pH probe.
3. Watch the pH display on the treatment tank pH meter. When the pH display stops changing, it is time to adjust the pH. If the pH is above the desired pH, turn on the acid pump to add acid to the treatment tank.
4. When the pH matches the desired value (within +/- 0.2) turn off the acid pump. Also turn off the pH recirculation pump.

RAISING THE pH (BASE ADDITION) – MANUAL (OPTIONAL)

1. Turn on the treatment tank agitator.
2. Turn on the pH recirculation pump. This circulates water from the treatment tank across the pH probe.
3. Watch the pH display on the treatment tank pH meter. When the pH display stops changing, it is time to adjust the pH. If the pH is below the desired pH, turn on the base pump to add base to the treatment tank.
4. When the pH matches the desired value, within (+/- 0.2) turn off the base pump. Also turn off the pH recirculation pump.

TREATMENT POWDER ADDITION - MANUAL

1. If not already running, turn on the treatment tank agitator.
2. Turn on the auger to add Treatment Powder to the treatment tank. Using the "Treatment Powder Addition Time" value, time the addition.
3. After the correct amount of Treatment Powder has been added, turn off the auger.

TREATMENT TANK MIX TIME - MANUAL

1. If not already running, turn on the treatment tank agitator.
2. Let the agitator run for the amount of time required for the appropriate "Mix Time."
3. When the "Mix Time" is over, turn off the treatment tank agitator.

SLUDGE SETTLE / REACTION TIME - MANUAL

1. If running, turn off the treatment tank agitator.
2. Leave the agitator off for the amount of time required for the appropriate "Sludge Settle / Reaction Time." When the "Sludge Settle / Reaction Time" is over, go on to the next step.

CLEAR WATER DISCHARGE TIME - MANUAL

1. Open the clear water valve to allow the water to flow onto the Bandfilter.
2. Watch the level in the treatment tank. When all clear water has been discharged, close the valve.

SLUDGE DISCHARGE TIME - MANUAL

1. Open the sludge valve to allow sludge to flow onto the Bandfilter.
2. Watch the level in the treatment tank. When all sludge has been discharged, close the sludge valve.

BANDFILTER OPERATION - MANUAL

Whenever the system is in the Clear Water or Sludge Discharge steps, the bandfilter must be manually operated. Watch the sludge accumulation on the bandfilter and advance the bandfilter when the plastic float, which rides on top of the bandfilter belt, begins to lift. Follow these steps:

1. Close the clear water valve or sludge valve (whichever happens to be open).
2. Turn on the bandfilter. The bandfilter advance speed can be adjusted through the speed dial on the control panel.
3. When the float drops back down onto clean filter media, turn the bandfilter off.
4. Open the clear water valve or sludge valve (whichever one is currently being used).

When all the sludge has been discharged from the treatment tank, the batch is finished.

03/02

SYSTEM CONTROLS

This system is designed to function as a fully automatic system requiring minimal operator intervention. The control panel consists of an operator interface keypad, pH meter(s), pushbuttons, and selector switches. The following describes the purpose and use of each device.

SYSTEM CONTROL PUSHBUTTONS

The following pushbuttons are used to put the system in automatic, put it on hold, acknowledge alarms, etc.

EMERGENCY STOP

Press this button to remove power from all devices. The button is lit when pulled out and not in an Emergency Stop condition.

CONTROL POWER

This switch turns on and off control power to the control panel. When control power is on, the light is on.

AUTO / MANUAL

Press this button to toggle between automatic and manual modes. The button is lit while in automatic.

AUTO – This is the normal operating mode for the system and should be used except when equipment malfunction necessitates manual operation. While in automatic all alarms are active and the system runs automatically as described in the “Detailed Automatic Step Descriptions” section.

To switch from manual to automatic, press the **AUTO / MANUAL** button. The system will go into automatic and the **AUTO / MANUAL** button will be lit. The system immediately goes on hold when switching to automatic, and the **HOLD / RESUME** button will be lit to indicate this. Press the **HOLD / RESUME** button to take the system out of hold.

MANUAL – The manual mode is to be used when manual operation of the system is required due to a malfunction with the equipment. Also, when the system is first powered up, it will be in manual.

To switch from automatic to manual, first press the HOLD / RESUME button to put the system on hold. The system will not allow switching from automatic to manual without first putting the system on hold. Then press the AUTO / MANUAL button to put the system in manual.

Please Note: Switching from automatic to manual during a treatment batch will reset the automatic sequence for that batch. The batch will have to be finished manually.

See the "Manual Operation Step Descriptions" section to treat a batch manually. While in manual all operations must be performed with the selector switches, although certain functions will operate automatically as follows:

- The equalization tank overflow alarm will activate if the level in the tank reaches the overflow probe. (Optional)
- The influent transfer pump will stop automatically when the water level in the treatment tank hits the overflow probe.

HOLD / RESUME

Press this button to toggle in and out of the hold mode. The button is lit while on hold. The system will automatically go on hold under the following circumstances:

- The system immediately goes on hold when switching from manual to automatic mode.
- Anytime that there is an alarm the system will go on hold.

The operator for the following reasons can put the system on hold:

- To attend to the system, such as changing the filter paper roll, for example.
- To perform an operation manually. While on hold, manual operation of all devices is possible without getting an "ALL SWITCHES NOT IN AUTO" alarm (see the "Alarms" section).
- To prevent batches from being treated while allowing the equalization tank agitator on/off cycle (optional) to operate.
- As a first step to reset the treatment batch and go into manual mode.

While on hold, all automatic batch operations stop, although certain functions will operate automatically as follows:

- The equalization tank agitator on/off cycle (optional) will continue to operate.
- The equalization tank overflow alarm will activate if the level in the tank reaches the overflow probe.
- The influent transfer pump will stop automatically when the water level in the treatment tank hits the overflow probe.

To take the system out of hold, press the HOLD / RESUME button. The button light will go out to indicate that the system is not on hold.

ALARM ACKNOWLEDGE

Press this button to silence the alarm buzzer when an alarm is activated. The button is lit when an alarm is initially triggered. After pressing this button, the alarm buzzer is silenced and the light flashes to indicate that the system is still in an alarm state. When the alarm state is removed, the light will go out. See the "Alarms" section for complete details.

SELECTOR SWITCHES

All moving devices are controlled through three-position selector switches. The switches operate as follows:

Motors and Pumps – ON / OFF / AUTO

- ON - The motor or pump runs while the switch is in this position.
- OFF - The motor or pump will not run while the switch is in this position.
- AUTO - The motor or pump will start and stop automatically according to the process sequence while the switch is in this position.

Actuated Valves – OPEN / CLOSED / AUTO

- OPEN - The valve is open while the switch is in this position.
- CLOSED - The valve is closed while the switch is in this position.
- AUTO - The valve will open and close automatically according to the process sequence, while the switch is in this position.

BANDFILTER SPEED - A speed dial controls the bandfilter belt speed. Whether in automatic or manual, the bandfilter speed is determined by the setting on this dial. The dial can be adjusted at any time.

OPERATOR SCREENS

BATCH STATUS SCREEN

When the process is running, this screen displays the current step that's running, the preset time for that step, and the time remaining in the step.

Access this screen by pressing the  button on the display keypad.

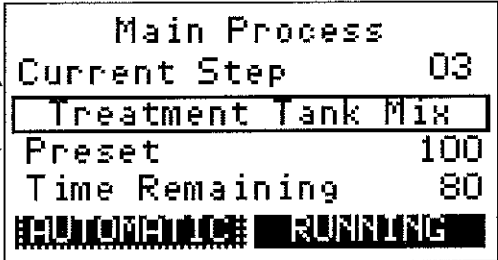

Displays the type of step in progress

Displays the total time allotted for the step.

Indicates if the system is in automatic.

AUTOMATIC – In auto
MANUAL – Not in auto

Displays the step number in progress.

Displays the time left to the end of the step.

Indicates if the system is in a batch.

RUNNING – Batch in process
IDLE – System waiting for water level in EQ tank
HOLD – System on hold
ALARM – System has an alarm

SYSTEM STATUS SCREEN

Access this screen by pressing the button  on the display keypad.

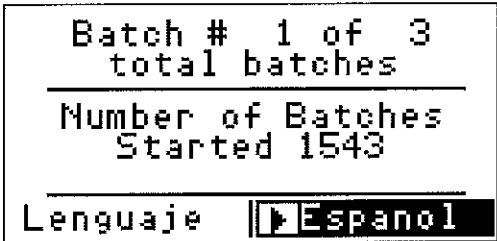

Number of batches to run in a cycle. This is used to allow the operator to stop the system after a certain number of batches

Number of total batches run since the totalizer counter was last reset (see the changing equipment automatic operation section to reset the totalizer)

PASSWORD ACCESS SCREEN

Access this screen by pressing the button  on the display keypad. This display will ask for a password. Enter the password using the number keypad. If the password is not known, check with the operator or supervisor. Once the password is entered press the return key to accept it. The setup screen selection menu will appear and a more detail explanation of these menus and screens if provided in the *Changing Equipment Automatic Operation* section.

FORMULA SELECT SCREEN

Access this screen by pressing the button  on the display keypad. This display will then take the operator to the formula select screen that allows the operator to choose which equalization tank the waste is to be pumped from and which programmed treatment formula to use.

The Formula Select Screen:

```
Current- Formula 1
Next    ► Formula 1
Formula ► Formula 2

Current Stream A
Eq Tank ► Stream A
        Stream B
```

Once the unit is in operation and a batch has been started, the operator can then change the desired equalization tank and formula for the next batch. The unit will finish the current batch in operation and start the next batch from the selected tank with the selected formula.

FORMULA EDITING OPERATION CYCLE KEY

This screen and button can only be used once the password access screen has been entered. Once the operator has access the setup screen selection menu, and enters the formula edit section, the  button is used to between toggle the operational functions in the formula.

ALARM STATUS SCREEN

This screen is accessed by pressing the  button on the display keypad. The button allows the operator to see the current alarm triggered. The operator can access any of the other screens while the unit is in an active alarm state and this button when pressed will take the operator back to the alarm screen.

Active Alarm Screen:

```

- A19 -
Treatment Tank
High Level Probe
Failure

```

AUTOMATIC **RUNNING**

DOUBLE ARROW KEYS



These buttons are used during the formula editing section. To move to the next or previous step, use the "Double Arrow Up/Down" buttons. Each press of a button will move the step up or down one.

SEQUENCE OF OPERATION

The CE system allows for a flexible formula sequence, enabling it to be tailored to the waste stream. The system goes through a number of steps to treat the wastewater and each step has one value (usually a time) associated with it. These steps are defined when the system is first started up and normally this sequence will not need to be changed. However, if the waste stream changes or new treatment chemicals become available, the flexibility is built into the system to allow for future sequence and/or step value changes. This section describes the structure of the sequence of operations. Refer to the "Changing Equipment Automation Operation" and "Formula Editing" sections for instructions on how to enter the values into the system controller, and see the "Automatic Treatment Step Descriptions" for a detailed description of each step.

There are certain steps that are always needed to treat a batch. At the beginning of the batch the agitator in the equalization tank must run for a few minutes to disperse the solids. Also, the treatment tank must be filled. Similarly, at the end of the batch, the treated water must be discharged. This is done through the decant and sludge discharge steps. But, in between the initial and final steps, there are a number of possible operations that perform the actual treatment of the wastewater. The sequence of these steps is selected to provide the best treatment.

With the system in auto, the water level in the equalization tank is continuously monitored to see if there is enough water to treat. When the tank level goes above the low-level probe, a batch automatically starts, providing that all selector switches are in auto, the last batch has finished, and there is dry product in the hopper.

TREATMENT FORMULA AND EQUALIZATION TANK SELECTION



The operator is able to choose which equalization tank the waste is to be pumped from, along with which formula he would like to treat with. The operator presses the formula select button located on the operator interface and selects which tank and formula to run. The operator can also change the selected formula and equalization tank for the next batch by selecting them here once a batch has started. On the next batch the unit will pump from the desired tank and treat per the selected formula.

The Treatment Formula and Equalization Tank Select Screen:

Current-	Formula 1
Next Formula	▶ Formula 1 Formula 2
Current	Stream A
Eq Tank	▶ Stream A Stream B

Once a batch starts, the following steps occur:

PRELIMINARY BATCH STEPS

The following two steps occur automatically prior to treatment.

EQUALIZATION TANK PRE-BATCH AGITATION

Before water is pumped from the equalization tank to the treatment tank, the equalization tank agitator runs for a period of time to ensure that any settled solids in the water are dispersed evenly.

The agitator will run only if the level is above the low-level probe. If the low-level condition is met the equalization tank agitator starts. At the same time, the "Pre-Batch Agitation Time" timer starts.

When the "Pre-Batch Agitation Time" timer has timed out, the equalization tank agitator stops and the treatment tank fill step begins.

TREATMENT TANK FILL

The influent transfer pump solenoid valve opens, causing the pump to transfer water from the equalization tank to the treatment tank.

The influent transfer pump continues to run until the treatment tank high level probe is satisfied. When the probe is satisfied, a timer will time out to prevent erroneous signals.

When this timer times out, the pump solenoid valve closes, the pump stops, and transfer is complete.

After transfer, the equalization tank agitator is controlled through the normal on/off cycle timers (see "Equalization Tank Agitator Cycle").

SELECTABLE STEPS

Once the treatment tank is full, the process moves on to the next step. The sequence of steps varies from system to system. These steps are defined in the Formula Editing section and listed in the table below. Refer to the "Formula Editing" section for a detailed description of these operations.

Operation	Value Range	Description
None	0	The system will skip this operation and move to the next
Check pH (optional)	0-140	Note: pH level is represented in the screen without a decimal point and to the tenths position (i.e. 7.5 pH is shown as 75) The treatment tank agitator runs and the pH recirculation pump starts. After 30 seconds the system reads the pH level and determines if the pH level is near the value within its tolerance (tolerance is set on the "pH Check" menu option of the previous screen). An alarm will sound if the pH is too high (Alarm 10) or too low (Alarm 11)

Operation	Value Range	Description
Adjust pH (optional)	0-140	<p>Note: pH level is represented in the screen without a decimal point and to the tenths position (i.e. 7.5 pH is shown as 75)</p> <p>The treatment tank agitator runs and the pH recirculation pump starts. After 30 seconds the system determines if acid or base is required to reach the value entered. If the pH of the treatment tank is lower than the value, base is added to raise the pH. If the pH of the treatment tank is higher than the value, acid is added to lower the pH</p> <p>In either case, if the pH is more than 2 pH (20 on the screen) away from the set point, the acid or base pump runs continuously. Once the pH is within 2 pH, the acid or base pump cycles on and off for accuracy.</p>
Treatment Powder Addition	0-900	<p>Treatment tank agitator runs and treatment powder auger starts and runs for number of seconds equal to value.</p> <p>Formulation Note: the treatment tank should be agitated prior to this step. Short runs of treatment powder in an un-agitated tank may result in treatment powder clumping in the treatment tank.</p>
Mix Slow (optional)	0-900	Treatment tank agitator runs slow using a variable speed drive for a number of seconds equal to the value
Mix	0-900	Treatment tank agitator runs at full speed for a number of seconds equal to the value
Settle	0-900	The system is idle for a number of seconds equal to the value. The agitator does not run.
Additive 1 (optional)	0-900	The agitator runs and the liquid additive 1 pump starts for a number of seconds equal to the value.
Additive 2 (optional)	0-900	The agitator runs and the liquid additive 2 pump starts for a number of seconds equal to the value.

FINAL STEPS

Once all selectable steps have finished, the following automatic steps occur:

BANDFILTER PRE-DECANT ADVANCE

The system advances the bandfilter to eliminate the sludge left from the last batch and provide clean filter media for the decant water. Once the time limit is completed, the system continues.

DECANT TIME

The decant valve opens allowing clear water to flow onto the bandfilter.

When the "Decant Time" timer times out the decant valve closes and the process moves on to the next step.

BANDFILTER PRE-SLUDGE ADVANCE

Once again, the bandfilter will advance to clear off any sludge and provide clean filter media for the sludge. After a programmed time, we move to the next step.

SLUDGE DISCHARGE STEP

When the decant step is done, the sludge valve opens, allowing sludge to flow onto the bandfilter. The dewatering cycle progresses until the tank is eventually emptied. Specifically, each time the sludge discharge valve opens a two-minute timer starts. If the sludge reaches the level probe before the timer ends, the timer resets and starts again the next time the valve opens. However, if the timer times out before the sludge reaches the probe it is assumed that the treatment tank is empty and the discharge cycle ends.

BANDFILTER OPERATION

This description of the bandfilter operation applies to both the decant and sludge discharge steps.

The treatment tank discharge valve (decant or sludge) opens to allow water and sludge to flow onto the bandfilter, and the fluid level typically rises. When the level reaches the bandfilter level probe, the treatment tank discharge valve closes. The sludge is then allowed to dewater for a time as determined by the

DEWATER TIME. When this timer ends, the bandfilter advances until the level drops below the probe. The bandfilter then continues to advance for a time as determined by the RUNTIME TIME to ensure that there is clean filter media available for the next discharge.

This shows how the cycle normally works with sludge:

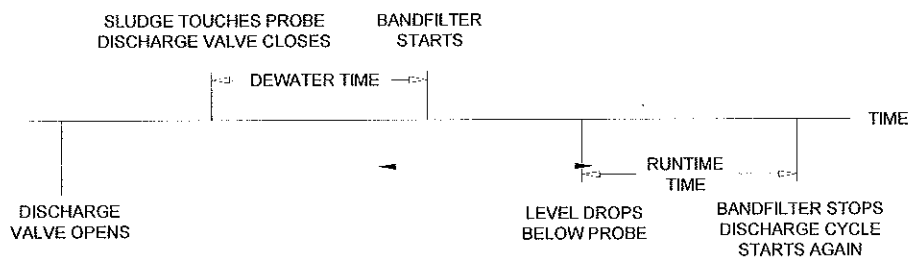

The DEWATER TIME and RUNTIME timers aren't tied together. RUNTIME (bandfilter extra advance time) starts timing as soon as the probe is uncovered, even if DEWATER TIME isn't timed out. The bandfilter starts when DEWATER TIME is done, and stops when RUNTIME times out. Since RUNTIME starts when the level drops below the probe, regardless of the status of DEWATER TIME, the bandfilter may not run for a long time when the water is clear and runs through the filter media easily. This helps conserve filter media and speeds the process along.

For example, the discharge valve opens and the level rises until it touches the probe. If the water is pretty clear at this point, it may go through the bandfilter quickly, uncovering the probe before the DEWATER TIME is done. As soon as the probe is uncovered, RUNTIME starts timing. So, if the level drops fast, the bandfilter won't advance much, if any. This is depicted as follows:

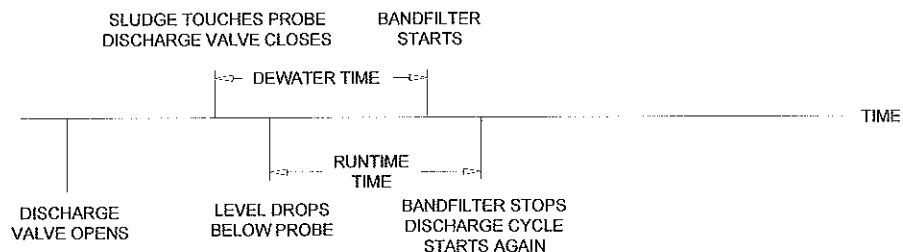

If the sludge dewateres very quickly, and RUNTIME is shorter than DEWATER TIME, the bandfilter may not run at all (it stops before it starts), as follows:

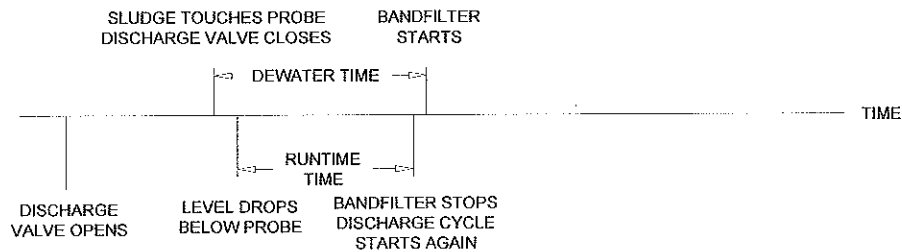

When the sludge step is completed, we move to the next step.

SPRAY WASH

After the sludge discharge step, a clean water valve opens and rinses the treatment tank of any remaining sludge. During this time, the sludge valve remains open to allow the rinse water to fall onto the bandfilter.

EFFLUENT PUMP

All treated water drips into the bottom, or effluent tank. The effluent pump will empty the effluent tank under two circumstances:

1. An automatic process completes its spray wash cycle and the effluent tank low level probe indicates there is water in the effluent tank.
2. The system was taken out of "Auto" mode while the effluent tank low level probe indicates there is water in the effluent tank.

Once one of these circumstances occurs, the effluent pump will activate and run until the effluent tank low level probe indicates the tank is empty and the effluent tank pump extended timer completes its time period.

Note: The effluent pump runs independently of the automatic process. A new batch may be running while the effluent pump is still pumping the effluent water from the previous batch.

EFFLUENT TANK AUTO SPRAY WASH (OPTIONAL)

When the effluent tank low level probe sees that the effluent tank is empty, the spray wash comes on and sprays the tank for a preset amount of time. The effluent pump will continue to pump during this time to drain the tank.

CHANGING EQUIPMENT AUTOMATIC OPERATION

The system operates on a series of timers and counters. These timers and counters are, for the most part, accessible with a password.

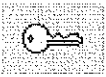

To access the password screen press the key icon button just under the display. The display will ask for a password. Enter the password using the number keypad. If the password is not known, check with the operator or supervisor. Once the password is entered, press the return key to accept it.

The setup screen selection menu appears. Below is a list of menu selections and values they control.

- Edit Formula – see formula editing at the end of this section.
- Edit Password

▼ for User <div style="border: 1px solid black; padding: 2px; text-align: center;">#####</div> ▲ for New <div style="border: 1px solid black; padding: 2px; text-align: center;">NEW PASSWORD</div> ▼ for Verify <div style="border: 1px solid black; padding: 2px; text-align: center;">VERIFY PASSWORD</div>	←	Current Operator
	←	Press ▲ to enter new password
	←	Press ▼ to verify new password

- Edit Batch Control

Batch Control Batches to Run ## 99 for Continuous	←	Enter the number of batches to run automatically. Enter the number 99 for continuous operation.
---	---	---

- Batch Counter Reset

Batch Counter Batch ID #### Reset Batch ID <div style="border: 1px solid black; padding: 2px; display: inline-block;">▶ Yes</div>	←	Enter YES to reset batch totalizer to zero
--	---	--

- Equalization Tank Agitator (Optional)

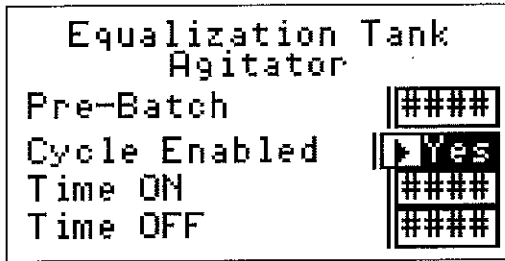

Prior to pumping to the treatment tank, EQ tank agitation is turned in for this time

"Yes" allows the cycle time on & off to run the EQ tank agitation

"No" runs the agitator constantly while in Auto

When cycle is enable, EQ agitation is cycled on & off for these time periods

- pH Check (Optional)

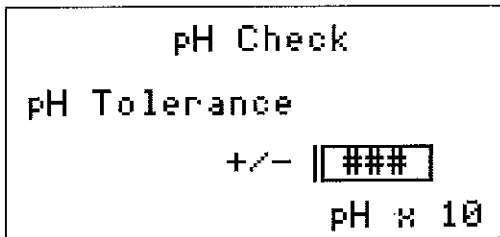

pH tolerance refers to the acceptable range of the pH during a pH check operation

Note: pH level is represented in the screen without a decimal point and to the tenths position (i.e. 7.5 pH is shown as 75)

- Treatment Tank

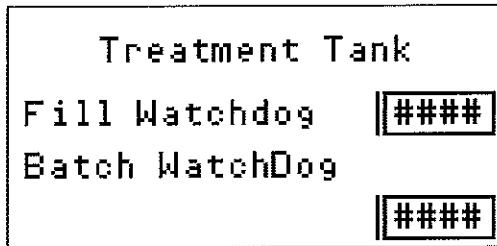

This timer starts when the treatment tank begins to fill. If the timer times out before the tank is full, Alarm A5 will sound.

This timer starts at the beginning of the batch. If this timer times out before the batch is completed, Alarm A6 will sound

- Treatment Tank Acid (Optional)

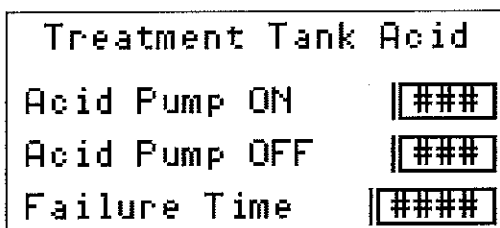

If pH is within 2 pH (20 on the screen) during a pH adjust step and acid is required, the acid pump will cycle based of these timers

Alarm A8 will sound if set point is not reached within this time period

- Treatment Tank Caustic (Optional)

```

Treatment Tank
Caustic
Caustic Pump ON  [###]
Caustic Pump OFF [###]
Failure Time     [####]
    
```

If the pH is within 2 pH (20 on the screen) during a pH adjust step and base is required, the base pump will cycle based off these times

Alarm A9 will sound if the set point is not reached within this time period

- Effluent Tank

```

Effluent Tank
Low Extend Pump Time
                    [###]
    
```

This time allows the continued operation of the effluent pump after the effluent tank low level shows that tank empty. This ensures the tank drains completely

- Effluent Tank Liquid Additive (Optional)

```

Effluent Tank
Liquid Additive
Addition Time     [##]
    
```

During the decant process, this time will run to add liquid additive to the effluent tank

- Bandfilter

```

Bandfilter
Runtime Time      [###]
Dewater           [▶ Yes]
Dewater Time     [###]
    
```

During the discharge cycle, the bandfilter fills and activates the float. Once the float drops and releases the micro-switch the bandfilter will continue to run for the programmed time. This timer runs in seconds, enter the correct amount of time desired in seconds.

- Reuse Tank (Optional)

Reuse Tank	
Agitator ON	####
Agitator OFF	####
pH Setpoint	####
pH Cycle Time	####

The reuse tank agitator runs on a "time on" – "time off" cycle. This sets those times

The set point for pH adjustment of the reuse tank s entered here

Note: pH level is represented in the screen without a decimal point and to the tenths position (i.e. 7.5 pH is shown as 75)

This time period is the time period between pH checks on the reuse tank

- Reuse Tank Acid (Optional)

Reuse Acid Pump	
Acid Pump ON	###
Acid Pump OFF	###
Failure Time	###

When acid is required to lower the pH of the reuse tank, it is pumped in using these "time on" – "time off" timers

Alarm A20 will sound if a pH adjustment starts but does not reach its set point within this time limit

- Reuse Tank Base (Optional)

Reuse Caustic Pump	
Caustic Pump ON	###
Caustic Pump OFF	###
Failure Time	###

When base is required to raise the pH of the ruse tank, it is pump in using these "time in" – "time out" timers

Alarm A21 will sound if a pH adjustment starts but does not reach its set point within this time limit

Other menu items appear but require a manufacturer's password to enter. Changes on these screens could result in unexpected equipment behavior. Please contact Ringwood Environmental, Inc. at 1-866-462-3826 should any of these screens need to be changed.

FORMULA EDITING



Before editing the formulas, a copy of the formula should be on hand for reference.

To edit the formula follow these steps:

1. Place the equipment in manual mode:

The formula edits will not be saved unless the equipment is in manual mode. To verify that equipment is in manual mode, the green "Auto" light should be off. If the equipment is in "Auto" (green light on), allow the system to complete the current batch and place the system in "Hold". When the system is in "Hold", the "Auto" light could be pressed to place the system in manual (green light off)



2. Select Formula:

This screen allows the operator to choose which formula the unit is using to treat the wastewater with. There are 15 different formulas that can be pre-programmed for different waste streams or characteristics. By using the Up/Down  arrow keys select which formula you would like run and press the  return key to accept.

A. The Screen:

```
Current Formula  Formula 12
Next Formula     Formula 10
                  Formula 11
                  Formula 12
```

3. Enter Password:

To access the password screen, press the key icon button  just under the display. This display will ask for a password, enter the password using the number keypad. If the password is not known, check with the operator or supervisor. Once the password is entered, press the return key to  accept it.

4. Select "Edit Formula" from Menu:

By using the Up/Down  arrow keys select "Edit Formula" from the top of the menu.  Press the return key to accept.

5. Edit the Formula:

A formula is a preprogrammed sequence of steps that the machine executes after filling the treatment tank. There are a total of 14

programmable steps per formula. Formulas also include discharge parameters that tell the equipment how long to keep the sludge and decant valves open.

A. The Screen:

```

Step Operation Value
## [Liqui*] #####
## [Adjust pH] #####
## [Mix Slow] #####
Formula 1 [ ] SCROLL [ ]
    
```

The step in the center is the current editable step. The formula number is indicated in the lower left corner.

Note: Changing the formula select switch at this point will not change the formula being edited.

B. Operations & Values:

Below is a table of available operations, reasonable values for those operations, and how the system uses those operations.

Note: Below is a list of all operations including those associated with optional equipment. The optional operations may not appear in systems which do not have those options installed.

Operation	Value Range	Description
None	0	The system will skip this operation and move to the next
Check pH (optional)	0-140	<p>Note: pH level is represented in the screen without a decimal point and to the tenths position (i.e. 7.5 pH is shown as 75)</p> <p>The treatment tank agitator runs and the pH recirculation pump starts. After 30 seconds the system reads the pH level and determines if the pH level is near the value within its tolerance (tolerance is set on the "pH Check" menu option of the previous screen). An alarm will sound if the pH is too high (Alarm 10) or too low (Alarm 11)</p>

Operation	Value Range	Description
Adjust pH (optional)	0-140	<p>Note: pH level is represented in the screen without a decimal point and to the tenths position (i.e. 7.5 pH is shown as 75)</p> <p>The treatment tank agitator runs and the pH recirculation pump starts. After 30 seconds the system determines if acid or base is required to reach the value entered. If the pH of the treatment tank is lower than the value, base is added to raise the pH. If the pH of the treatment tank is higher than the value, acid is added to lower the pH</p> <p>In either case, if the pH is more than 2 pH (20 on the screen) away from the set point, the acid or base pump runs continuously. Once the pH is within 2 pH, the acid or base pump cycles on and off for accuracy.</p>
Treatment Powder Addition	0-900	<p>Treatment tank agitator runs and dry product auger starts and runs for number of seconds equal to value.</p> <p>Formulation Note: the treatment tank should be agitated prior to this step. Short runs of dry product in an un-agitated tank may result in dry product clumping in the treatment tank.</p>
Mix Slow (optional)	0-900	Treatment tank agitator runs slow using a variable speed drive for a number of seconds equal to the value
Mix	0-900	Treatment tank agitator runs at full speed for a number of seconds equal to the value
Settle	0-900	The system is idle for a number of seconds equal to the value. The agitator does not run.
Additive 1 (optional)	0-900	The agitator runs and the liquid additive 1 pump starts for a number of seconds equal to the value.
Additive 2 (optional)	0-900	The agitator runs and the liquid additive 2 pump starts for a number of seconds equal to the value.

C. Editing the Step:



To change the operation, use the "Operation Cycle" button. Each press cycles to the next available operation step.

To edit that value, simply key the new value using the numerical keypad.

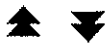

To move to the next or previous step, use the "Double Arrow Up/Down" buttons. Each press of a button will move the step up or down one.

D. Editing Discharge Parameters:



While in the formula edit screen, pressing the "key" button will change screens to the discharge parameter screen. Here the bandfilter pre-decant advance timer, decant timer, bandfilter pre sludge advance timer, sludge discharge timer, and treatment tank spray wash timer are entered. Use the left and right arrow keys to cycle between the values and the keypad to enter new values. Press the "key" button to return to formula edit screen.



E. Returning to the Main Screen:



In the formula edit screen, pressing the "main" screen button will return to the operation and save changes made to the formula.

ALARM DESCRIPTIONS AND TROUBLESHOOTING GUIDE

The following alarms are present to alert the operator when the system is not operating correctly. Some alarms are always active, others only at certain times or under certain conditions. The following alarm descriptions outline the conditions under which each alarm is active. If an alarm is triggered, the following occurs:

- The buzzer sounds and the light on the ALARM ACKNOWLEDGE pushbutton is lit.
- If in auto, the system goes into hold. (See "System Controls" for a description of what happens in hold.)

Press the ALARM ACKNOWLEDGE pushbutton to silence the buzzer. The light on this button will flash to signal that an alarm condition is still present. The alarm condition must be eliminated before the system can be put back into automatic operation. To remove the alarm condition, operate the system manually and follow the steps described below in the appropriate Troubleshooting Tips.

Alarm A1



- A1 -
Equalization Tank
Overfilled

AUTOMATIC **RUNNING**

Description:

The equalization tank overflow probe is monitored continuously whether in auto or not. If the level in the equalization tank reaches the overflow probe, the alarm is triggered.

This alarm will not put the system on hold. The alarm buzzer will sound (momentarily, every minute), but the treatment process will continue.

Troubleshooting Tips:

- Stop all pumps that feed the equalization tank. A relay contact is available for customer use to automatically turn off the pumps that feed the equalization tank. Refer to the electrical schematic drawings to locate the terminals for this contact.
- The treatment system should be checked to make sure that batches are being treated. Verify that the system is in AUTO, that all the switches are in AUTO, and that it is not on HOLD. If the system is still not starting batches automatically, there may be a problem with the equalization tank batch start level probe, since this probe is responsible for initiating a batch.
- If this alarm occurs and the level is below the overfill probe, there may be a problem with the probe.

A qualified technician should examine the probe to ensure that the switch inside changes state when the probe is turned up and down (cord on bottom or cord on top).

Alarm A2**Description:**

The Equalization Tank agitator overload is monitored anytime that the agitator is supposed to be running. If the overload trips, this alarm is triggered.

Troubleshooting Tips:

- Anything that will cause the load on the motor to increase will cause this alarm. Check for mechanical problems, such as bad bearings or binding on the shaft or propeller.
- After making sure that the shaft should be able to turn freely, a qualified technician should reset the overload inside the control panel. Try to run the agitator manually by turning the switch on the control panel door to ON.

- If the overload trips again, the motor and gearbox should be examined for damage and repaired or replaced as needed.

Alarm A3**Description:**

The selector switches on the control panel are monitored continuously whenever the system is in auto. If a switch is turned to any position besides AUTO, this alarm is triggered.

Troubleshooting Tips:

- Put all switches in AUTO to continue.
- If all switches are in the AUTO position and this alarm is still present, there is an electrical problem with a switch. A qualified technician should troubleshoot the wiring and switches. Refer to the electrical schematic drawings for assistance.

Alarm A4**Description:**

The " Maximum Batch Time" timer starts when the batch does. The first step of the batch is the Equalization Tank Pre-Batch Agitation, and the last step is the Sludge Discharge. If the batch is not completed within this time, the alarm is triggered.

Troubleshooting Tips:

- This alarm is caused by some part of the process taking too long. If the pH steps cause alarms then this alarm may sound toward the end of the batch.

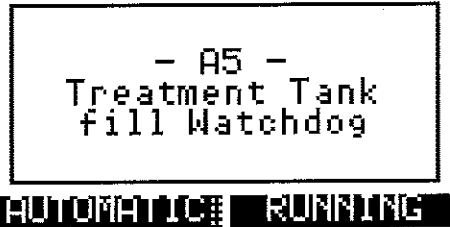
Alarm A5**Description:**

The "Influent Pump Maximum Time" timer starts with the treatment tank automatic fill cycle. If the treatment tank is not filled within this time, the alarm is triggered.

Troubleshooting Tips:

- Check that there are no manual valves closed either in the influent water line or airline to the influent transfer pump.
- Check that the influent transfer pump is operating correctly by running it manually. If the pump doesn't run in manual, check that there is air pressure to the pump. If so, there may be a problem with the solenoid valve.

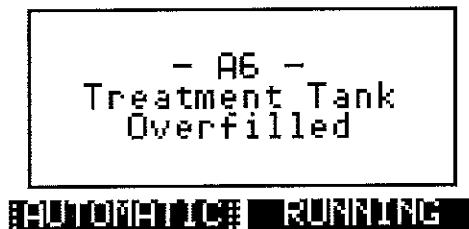
Alarm A6**Description:**

The treatment tank overflow probe is monitored continuously during a batch, whether in auto or not. If the level in the treatment tank reaches the overflow probe, the alarm is triggered.

Troubleshooting Tips:

- If the tank has overflowed, there may be a problem with the treatment tank full level switch, since it did not stop the influent transfer pump like it is supposed to.
- If the treatment tank level is below the overflow probe and this alarm occurs, there is likely a problem with the overflow probe.
- There could also be a problem with the influent transfer pump solenoid valve. It may have stuck open, causing the pump to continue to run.

Alarm A7

```
      - A7 -  
    Treatment Tank  
    Agitator Overload
```

```
AUTOMATIC RUNNING
```

Description:

The Treatment Tank agitator motor overload is monitored anytime that the agitator is supposed to be running. If the overload trips, the alarm is triggered.

Troubleshooting Tips:

- Anything that will cause the load on the motor to increase will cause this alarm. Check for mechanical problems, such as bad bearings or binding on the shaft or propeller.

Alarm A8

```
      - A8 -  
    Treatment Tank  
    Acid Delivery  
    Failure
```

```
AUTOMATIC RUNNING
```

Description:

The "acid addition too long time" timer starts with the automatic acid addition step. If the timer times out before the pH set point is reached, the alarm is triggered.

Troubleshooting Tips:

Warning: Always follow OSHA guidelines and wear appropriate protective equipment when working near acid. Acid drums and related equipment should not be handled by anyone who is not familiar with OSHA Safety Guidelines (training and guidelines supplied by customer training program).

- The most likely cause of this alarm is that the acid drum is empty. Check that the drum has acid in it and that the siphon tube is all the way in. Replace the drum if needed.
- If there is acid in the drum then there may be a problem with the acid pump. Try to operate the pump manually by turning the switch on the front of the control panel to ON. If the pump strokes but does not pump the acid, then the pump may have lost its prime or there is a leak in the line.
- If the pump does not strike, there could be a problem in the pump. Repair or replace as needed.

Alarm A9



Description:

The "Base addition too long time" timer starts with the automatic base addition step. If the timer times out before the pH set point is reached the alarm is triggered.

Troubleshooting Tips:

Warning: Always follow OSHA guidelines and wear appropriate protective equipment when working near base. Base drums and related equipment should not be handled by anyone who is not familiar with OSHA Safety Guidelines (training and guidelines supplied by customer training program).

- The most likely cause of this alarm is that the base drum is empty. Check that the drum has base in it and that the siphon tube is all the way in. Replace the drum if needed.
- If there is base in the drum then there may be a problem with the base pump. Try to operate the pump manually by turning the switch on the front of the control panel to ON. If the pump strokes but does not pump the base, then the pump may have lost its prime or there is a leak in the line.
- If the pump does not strike, there could be a problem in the pump. Repair or replace as needed.

Alarm A10

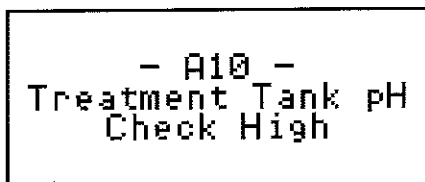

- A10 -
Treatment Tank pH
Check High



AUTOMATIC RUNNING

Description:

This alarm is activated if the pH check step is selected in the equipment setup listing for your system's Sequence Of Operation (see "Detailed Process Step Description). If the pH does not get checked, then this alarm is not active. If active, at the end of the pH probe recirculation timer, the pH value of the water in the treatment tank is compared against the high set point in the pH analyzer. If the actual pH is above the set point, the alarm is triggered.

Troubleshooting Tips:

- Check the pH of the influent water with a handheld pH probe or check the calibration of the pH probe in the pH recirculation line on top of the treatment tank. This is to verify that the pH of the water really is higher than normal.
- If the pH is indeed high, the batch may need special attention to verify that it treats correctly. Check for floc separation after treating. If the water is not treated, lower the pH by manually adding acid, then add more RM-10. Make sure that the water is treated before decanting or discharging sludge.
- If the pH probe is out of calibration, calibrate it.

Alarm A11**Description:**

This alarm is activated if the pH check step is selected in the equipment setup listing for your system's Sequence Of Operation (see "Detailed Process Step Description"). If the pH does not get checked, then this alarm is not active. If active, at the end of the pH probe recirculation timer, the pH value of the water in the treatment tank is compared against the low set point in the pH analyzer. If the actual pH is above the set point, the alarm is triggered.

Troubleshooting Tips:

- Check the pH of the influent water with a handheld pH probe or check the calibration of the pH probe in the pH recirculation line on top of the treatment tank. This is to verify that the pH of the water really is lower than normal.
- If the pH is indeed out of tolerance, the batch may need special attention to verify that it treats correctly. Check for floc separation after treating. If the water is not treated, raise the pH by manually adding base, then add more dry treatment powder. Make sure that the water is treated before decanting or discharging sludge.
- If the pH probe is out of calibration, calibrate it.

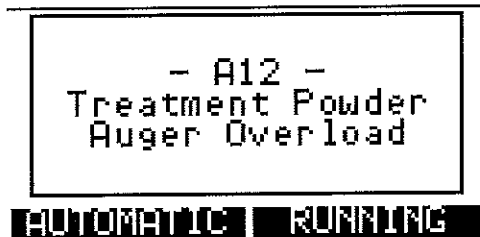
Alarm A12**Description:**

The Dry treatment powder hopper auger motor overload is monitored while the auger is supposed to be running. If the overload trips, the alarm is triggered.

Troubleshooting Tips:

- Anything that will cause the load on the motor to increase will cause this alarm. Check for mechanical problems, such as bad bearings or binding on the shaft or propeller.

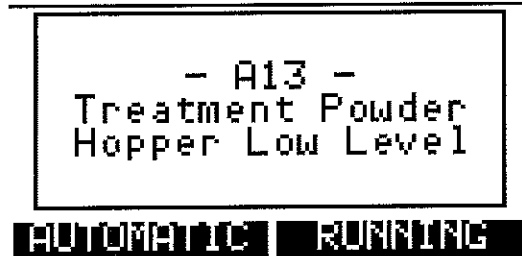
Alarm A13**Description:**

The treatment powder hopper low level probe is checked as a condition for a batch to start. If the level is low, the batch will not start and the alarm will be triggered. Treatment powder must be added to cover the probe. Place a new bag of Dry product on top of the hopper for the batch to start.

Troubleshooting Tips:

- If there is sufficient treatment powder in the hopper to cover the low-level probe and the alarm is triggered, there is probably a problem with the probe. Check it and replace if needed.

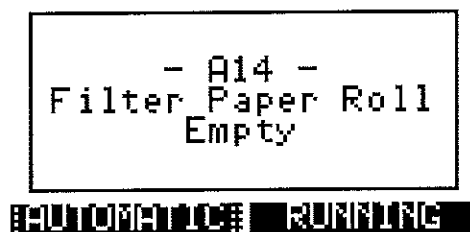
Alarm A14**Description:**

The filter media photo eye checks for the presence of filter media during decant and sludge discharge steps.

Troubleshooting Tips:

- The most likely cause for this alarm is that the media roll is empty. Replace it and continue the batch.
- If the roll is not empty then there may be a problem with the media sensor. The sensitivity of the sensor may be too low, or it may need to be replaced.

Alarm A17

- A17 -
Effluent Tank not
Empty



AUTOMATIC RUNNING

Description:

During the following batch, at the start of the decant step, the effluent tank is checked to see if it is empty according to the effluent tank level probe. If the tank is not empty at this time, this alarm is triggered.

Troubleshooting Tips:

- Check that there are no manual valves closed either in the effluent water line or airline.
- Check that the effluent drain valve or transfer pump is operating correctly by running it manually. If the drain valve or pump doesn't run in manual, check that there is air pressure. If so, there may be a problem with the solenoid valve.
- If the effluent tank is empty and this alarm occurs, there is likely a problem with the low-level probe.

Alarm A18

- A18 -
Sump Full Alarm



AUTOMATIC RUNNING

Description:

An input is provided for a sump overflow alarm input. This will not stop the process or put the system in hold. A short burst from the alarm horn every minute indicates this alarm.

Troubleshooting Tips:

- Check that the sump pumps are operating correctly and that no manual valves are closed.
- Have a qualified technician check the operation of the level probe and input.

Alarm A19

```
  - A19 -  
  Treatment Tank  
  High Level Probe  
  Failure  
  
AUTOMATIC RUNNING
```

Description:

When the system starts the sludge discharge portion of the batch after decant discharge and the treatment tank high level probe is active showing the treatment tank still full, this alarm sound to indicate a problem with the decant process.

Troubleshooting Tips:

- Check the treatment tank:
 - If level is high, check the decant valve by manually opening it with the control panel switch
 - If level is at the stand pipe, check the full level probe for proper operation

Alarm A20

```
  - A20 -  
  Reuse Tank Acid  
  Delivery Failure  
  
AUTOMATIC RUNNING
```

Description:

The reuse tank started a pH adjustment, but the failure timer completed before the set point was reached.

Troubleshooting Tips:

Warning: Always follow OSHA guidelines and wear appropriate protective equipment when working near acid. Acid drums and related equipment should not be handled by anyone who is not familiar with OSHA Safety Guidelines (training and guidelines supplied by customer training program).

- The most likely cause of this alarm is that the acid drum is empty. Check that the drum has acid in it and that the siphon tube is all the way in. Replace the drum if needed.
- If there is acid in the drum then there may be a problem with the acid pump. Try to operate the pump manually by turning the switch on the front of the control panel to ON. If the pump strokes but does not pump the acid, then the pump may have lost its prime or there is a leak in the line.
- If the pump does not strike, there could be a problem in the pump. Repair or replace as needed.

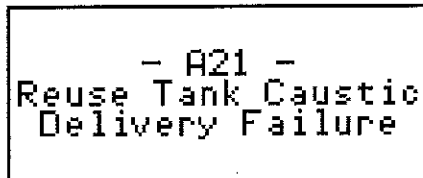
Alarm A21

- A21 -
Reuse Tank Caustic
Delivery Failure



AUTOMATIC RUNNING

Description:

The reuse tank started a pH adjustment, but the failure timer completed before the set point was reached.

Troubleshooting Tips:

Warning: Always follow OSHA guidelines and wear appropriate protective equipment when working near base. Base drums and related equipment should not be handled by anyone who is not familiar with OSHA Safety Guidelines (training and guidelines supplied by customer training program).

- The most likely cause of this alarm is that the base drum is empty. Check that the drum has base in it and that the siphon tube is all the way in. Replace the drum if needed.

- If there is base in the drum then there may be a problem with the base pump. Try to operate the pump manually by turning the switch on the front of the control panel to ON. If the pump strokes but does not pump the base, then the pump may have lost its prime or there is a leak in the line.

- If the pump does not strike, there could be a problem in the pump. Repair or replace as needed.

pH PROBE CALIBRATION PROCEDURE

This procedure uses the 2 Point Buffer method described in the Shark manual and requires you to enter the known pH values of two pH buffers. Follow these steps:

1. Immerse the sensor in the first buffer. Important: Allow the sensor and buffer temperatures to equalize. Depending on their temperature differences, this may take 30 minutes or more. When ready, press the DOWN key to display "CALIBRATION".
2. Press the <> key to display "MANUAL CAL PH".
3. Press the <> key again to display "IF BUFFER 1 READY PRESS 'DOWN'".
4. Press DOWN. Once the DOWN key is pressed the controller will read the pH value, averaging a number of results to get a stable calibration value. The display will read "RUNNING MANU CAL BUFFER 1 WAIT....."
5. Please wait for the controller to complete the measurement. When complete, the controller will report the measured value. Use the UP and DOWN keys to adjust the reading until it agrees with the actual buffer pH value. The display will read "MANUAL CAL pH BUFFER 1 x.xx>." Then use the <> key to move the cursor to the RH (>) position and press the DOWN key to store the value and move to Buffer 2.
6. Remove the probe from the first buffer. Clean and rinse the probe with clean water and then insert it in the second buffer. The display will read "IF BUFFER 2 READY PRESS 'DOWN'". Press the DOWN key.
7. The controller will read the pH value, averaging a number of results to get a stable calibration value. Please wait for the controller to complete the measurement. The display will read "RUNNING MANU CAL BUFFER 2 WAIT...."
8. Please wait for the controller to complete the measurement. When complete the controller will report the measured value. Use the UP and DOWN keys to adjust the reading until it agrees with the actual buffer pH value. The display will read "MANUAL CAL pH BUFFER 2 x.xx>." Then use the <> key to move the cursor to the RH (>) position and press the DOWN key to store the value and complete the manual calibration.
9. After 5 seconds, the controller will compute the slope of the calibration, the estimated probe efficiency and the probe temperature. The display will read something like "SLOPE 61.22mV/pH EFF 95% 24.8C". The slope should be between 50 and 62 mV/pH and above 80% efficiency for optimal sensor performance. Typically, as the sensor ages and/or becomes dirty, its slope decreases. When the slope is less than 54mV/pH, clean the sensor to improve its performance and consider replacing it.
10. If the calibration is okay, use the <> key to move the cursor over the "Y" text and press the DOWN key to store the calibration and return to the MANUAL CAL menu so the user can select another function. If the calibration did not appear to be correct, select the "N" text to return to the calibration menu and repeat the procedure.
11. When finished with the calibration, press the UP and DOWN keys at the same time to return immediately back to the run mode.

FILTER MEDIA ROLL CHANGE PROCEDURE

The following steps are required to replace an empty filter media roll:

1. Remove the locking pins and swing the ladder out of the way.
2. Remove the locking pin, reach in and lift up on the shaft, and swing the shaft cradle out of the way.
3. Using a ¼" Allen wrench, loosen the setscrew on the media shaft collar. Slide the collar off the shaft.
4. Slide the old media roll off the shaft.
5. Install the new media roll such that the media will feed out from the bottom of the roll. Slide the new roll onto the shaft until it hits the far shaft collar. The collars are positioned such that they hold the media roll centered on the bandfilter.
6. Slide the shaft collar back onto the media shaft and tighten the setscrew.
7. Swing the shaft cradle back into place and replace the locking pin. Swing the ladder back into place and replace the locking pins.
8. Unroll the filter media from the roll and overlap it with the trailing edge of the existing piece. Wet both pieces and they should stick together well enough. If not, it may be necessary to tape the new piece to the old one.
9. Run the bandfilter manually by turning the switch on the front of the control panel to ON. Watch the new media to make sure that it feeds under the side aprons without snagging.
10. When the new media has gone through the squeeze rollers, turn the bandfilter off and return the system to automatic.

MAINTENANCE SCHEDULE AND PROCEDURES

The following maintenance tasks are listed to ensure that all equipment is provided with the minimum attention necessary to ensure proper operation. Should you encounter equipment difficulties that exceed routine maintenance tasks, please refer to the vendor information at the end of this manual.

PLEASE NOTE: *Under no circumstances should your equipment be modified or worked on by anyone who is not familiar with OSHA Safety Guidelines: (Training and guidelines supplied through the customer's own training program.)*

Before working on any equipment listed below, ensure that all utilities are at a zero energy state. The zero energy state conditions require that all electrical power is disconnected and locked out, all air pressure is exhausted from air lines, steam is evacuated to zero pressure with valves closed, and that interconnected equipment is idled.

EQUALIZATION TANK

Agitator – Monthly check the oil level in gearbox.

Diaphragm Pumps – Weekly check the oil level in the airline lubricator and set for 1 drop per minute while the pump is running. Use SAE 90 wt. Non-detergent oil Supplied by customer.

Level probes - Weekly check the probes for material buildup and clean if necessary.

Solenoid valve for Diaphragm Pump - Monthly check for sluggish valve operation, excessive leakage, or noise.

CE SYSTEM

Tanks – Weekly wash out treatment and effluent tanks to minimize build-up.

Treatment Powder Hopper Auger - Monthly check the oil level in gearbox.

pH Recirculation Diaphragm Pump (Optional Equipment) - Weekly check the oil level in the airline lubricator and set for 1 drop per minute while the pump is running. Use SAE 90 wt. Non-detergent oil

Acid and Base Pumps (Optional Equipment) – Weekly check for leaks.

pH probes (Optional Equipment)

- Weekly check probe, accuracy and clean if necessary (see “pH Probe Inspection and Accuracy Check” procedure).
- Every 3 months clean and recalibrate (see “pH Probe Calibration” procedure).

Level probes - Weekly check the probes for material buildup and clean if necessary.

Solenoid valves - Monthly check for sluggish valve operation, excessive leakage, or noise.

Valve actuators - Monthly check for sluggish valve operation, excessive leakage, or noise.

Bandfilter Bearings – Monthly add grease.

Bandfilter Gearmotor - Monthly check the oil level in gearbox.

TREATMENT POWDER HOPPER AND AUGER INSTALLATION GUIDE

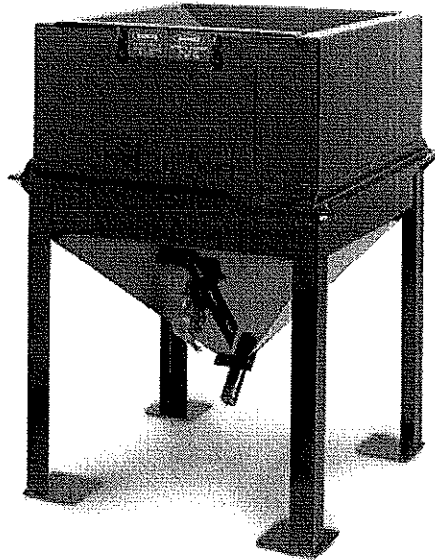

 **Ringwood**
Environmental, Inc.

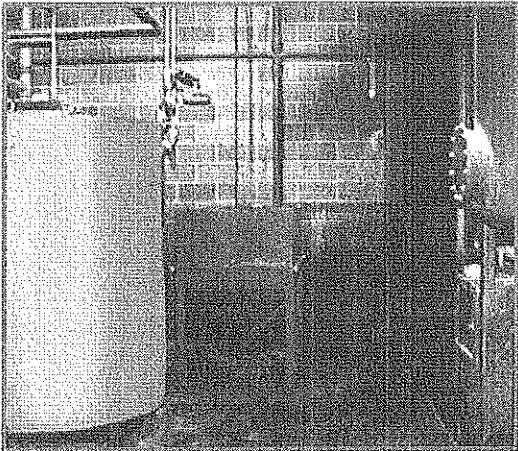

Photo 1

Locate the hopper (see photo 1) in a convenient location based on the layout drawing (if available) or on the following guidelines:

Superbag hopper should be accessible by forklift to place a superbag on top.

Hopper should be located on the same side of the CE System as the auger drive.

Distance from the treatment tank to the hopper should be between 3 and 10 feet.



Photo 2

Mount the drive assembly to the top of the CE System (if not already done). Use four bolts, nuts and lock washers to attach it to the top of the tank. Center and align the drive over the square hole and tighten the nuts.

Unbolt and remove the cover plate on the auger drive housing (see photo 2).

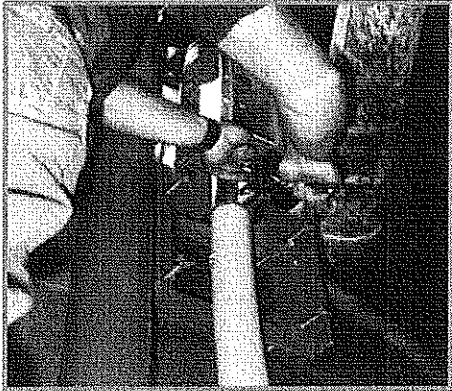

Photo 3

Attach one end of the plastic tube to the drive housing using the gasketed coupling. Be sure to push the tube all the way up to the metal tube on the housing. Center the coupling over both pieces of tube and tighten the bolt on the coupling (see photo 3).

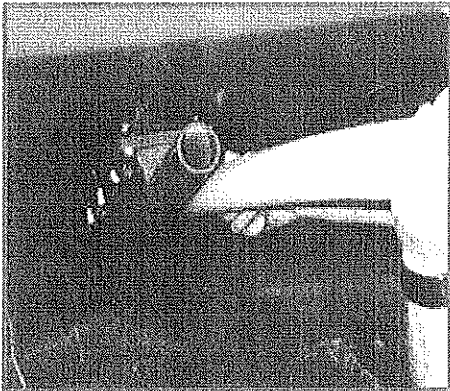

Photo 4

Hold the other end of the tube to the discharge tube of the hopper. Try to bend the tube such that there is a gentle curve without excessive stress at either end. If the tube is not long enough to reach the hopper, extend it by using the other piece of tube and joining the two with the gasketed coupling. Center the coupling over both pieces of the tube and tighten the bolts on the coupling. Mark the plastic tube where it will join the hopper discharge tube. This is where the tube will be cut (see photo 4).

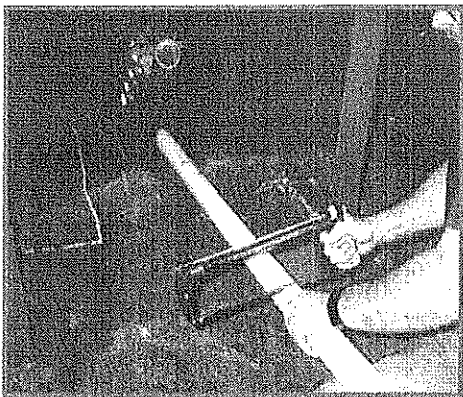

Photo 5

Use a hacksaw to cut the plastic tube at the mark (see photo 5).

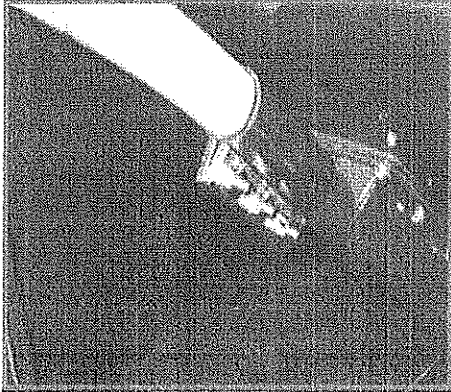

Photo 6

Attach the plastic tube to the hopper discharge tube using the gasketed coupling. Be sure to butt it up to the metal discharge tube on the hopper. Center the coupling over both pieces of tube and tighten the bolts on the coupling (see photo 6).

Adjust the position of the hopper if necessary to provide a smooth sweep of the tube. Then anchor the hopper to the floor.

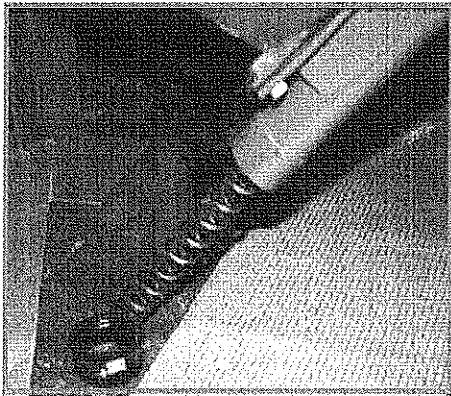

Photo 7

Thread the spiral flighting through the tube, starting at the bottom of the hopper. Push it all the way through until it reaches the drive housing. In the drive housing, line up the end of the flighting with the clamping bolt on the stub shaft, and turn the flighting to thread the tip of the flighting through the clamping bolt just enough to hold it in place. Do not thread it all the way through. Down at the hopper, mark the flighting in line with the bottom end of the discharge tube (see photo 7). Back out the flighting and use a hacksaw or bolt-cutter to cut the flighting at the mark.

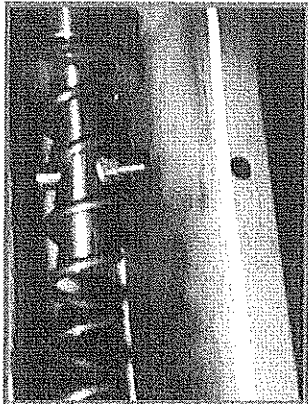

Photo 8

Thread the flighting through the hole in the clamping bolt on the stub shaft and continue until it hits the coupling (see photo 8). Tighten the clamping bolt. At the bottom of the hopper, the end of the flighting should be about 2" in from the bottom end of the steel discharge tube. If using a powder in this hopper (not common), thread the solid plastic rod through the center of the spiral flighting until it hits the stub shaft in the drive housing. Two or more pieces of rod can be butted up to one another as necessary. Cut the rod to size as necessary.

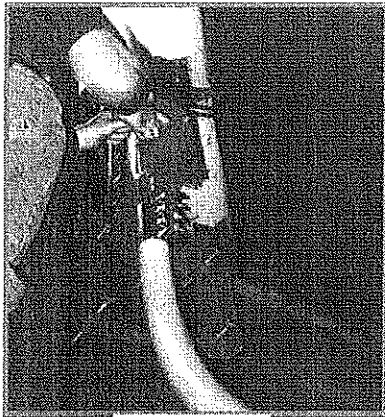

Photo 9

Replace the cover plate on the auger drive housing and tighten the bolts (see photo 9).

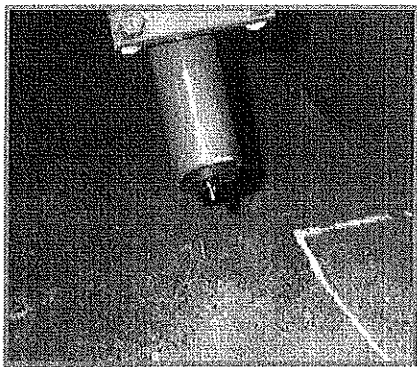

Photo 10

At the hopper, insert the plug in the bottom end of the steel discharge tube, making sure it doesn't touch the flighting. Tighten the wingnut to secure it in place (see photo 10).

Run 3/8" flexible tubing from the air feed on the CE System to the vibrator on the hopper. Use cable ties to attach it to the auger tube.

CE Wastewater Treatment System Spare Parts List

Quantity	Description	Part #	Cost
1	Bandfilter Drive DC Motor *	4190153	\$ 487.00
1	Bandfilter Drive Board *	4190173	\$215.00
1	Bandfilter Drive Resistor *	3320028	\$8.64
1	Bandfilter Level Probe	5830030	\$621.00
1	Treatment Powder Hopper Level Probe	5830166	\$186.00
13'	Treatment Powder Auger Screw Flighting *	2190008	\$442.00
1	Filter Media Alarm Photo Switch	5830134	\$222.00
1	Float-Type Level Switch	5830110	\$50.00
1	Treatment Tank Overfill Level Switch	5630108	\$56.00
1	Panelview Operator Interface	5700140	\$958.00
1	Solenoid Valve for Diaphragm Pump *	7501	\$107.00
1	Solenoid Valve for Treatment Tank Discharge Valves *	4280040	\$194.00
1	3" Actuated Decant Discharge Valve	2160749	\$614.00
1	4" Actuated Sludge Discharge Valve	2160743	\$814.00
1	Acid / Caustic Metering Pump *	5410176	\$432.00
1	Solenoid Valve for Acid / Caustic Metering Pump *	7504	\$108.00
1	pH Probe- Aquametrix *	5830180	\$312.00
1	pH Analyzer- Aquametrix *	5830189	\$1,190.00
1	pH Buffer - 4.01 (Box of 20)	5830063	\$38.00
1	pH Buffer - 7.00 (Box of 20)	5830069	\$38.00
1	pH Buffer - 10.00 (Box of 20)	5830064	\$38.00
1	pH Recirculation Pump	5410138	\$1292.00
1	Wet End Repair Kit for pH Recirculation Pump *	5410141	\$450.00
1	Air End Repair Kit for pH Recirculation Pump *	5410113	\$72.00

Notes:

- * Noted items are considered critical to run the system manually through the switches on the control

- panel. To be able to maintain automatic operation of the system, all parts should be purchased.
2. Other parts necessary to run the system (3 phase motors, for example) are not listed since these should be readily available from local suppliers.
 3. Delivery is subject to availability of parts at time of order.
 4. Depending on equipment purchased, some items may also appear on additional Spare Parts Lists.



Winnipeg Cetco Daily Inspection Form

Site: Winnipeg		Document ID: GFL-OPS-WIN-001-F3	
Author: HSE Coordinator		Category: Form	
Approver: General Manager		Approval Date: October 21, 2015	Rev. No.: 0
Document Location (Edmonton office): Public(P:)/Compliance/Safety, Policy, Procedure/Policy Docs –pdf FINALS/Policy FINALS			

Inspection Date:	Time: _____ AM/PM
Inspected By:	Signature: _____

CETCO Equipment	YES	NO	Comments/Action/Completion Date
Hoses free of leaks			
Valves free of leaks			
Area by Cetco controls tidy and free of debris			
Sufficient stock of filter paper/RM10			
Cetco controls working properly			
Cetco machine/equipment wiped down thoroughly			
Tank conditions satisfactory			
Fill RM10 bin			

Task(s) to be completed:

Comments:

Manager Name:	Date Reviewed:
---------------	----------------

Hardcopies of this document are uncontrolled and may be assumed current only at the time of printing.

Appendix E: Aerosolv® Operating Manual

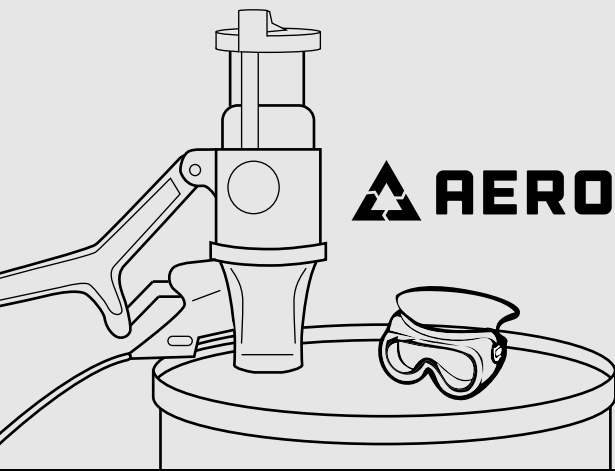

 **AEROSOLV**® **AEROSOL CAN RECYCLING**

Patents 5,265,762. U.S. and other patents pending.

SAFETY INSTRUCTIONS

1. Wear safety goggles while operating Aerosolv.
2. DO NOT use Aerosolv while smoking or near open flame.
3. Install Anti-Static Wire to properly "ground" drum.
4. Combination Filter MUST be installed prior to using Aerosolv, Replace Carbon Cartridge as indicated.
5. DO NOT use Aerosolv on a drum with less than 20-gallon capacity.
6. Remove Aerosolv to an empty drum once collection drum is 70% full (when contents reach within 10" of the top).
7. Always engage sliding top plate against can being punctured.
8. Always operate AEROSOLV system outdoors or in a well-ventilated area.
9. **Tip:** Avoid puncturing aerosol cans of cold galvanizing compound or insulation foam, unless can is empty.

AEROSOLV® **INSTALLATION**

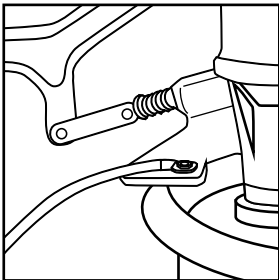

- **Aerosolv Unit:** Thread Aerosolv into 2" bung of drum, Rotate clockwise until ground support plate firmly engages drum rim. See lower right side of photo.
- **Filter:** Thread directly to 3/4" bung of drum.
- **Anti-Static Ground Wire:** Attach ring terminal of Anti-Static Wire to brass screw on Aerosolv Ground Support Plate
- Attach alligator clip of Anti-Static Wire to any nearby confirmed ground source, ex: metal pipe.

USING AEROSOLV[®]

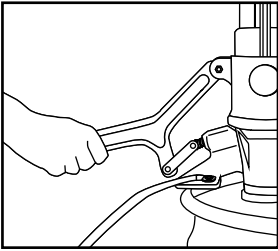

- Wear safety goggles while operating Aerosolv
 - Insert aerosol can, NOZZLE END DOWN, into Aerosolv housing sleeve, so that shoulder of can rests on gasket. For 1" "mini-cans", push shoulder of can beyond gasket. Be sure to remove cap from aerosol can prior to insertion.
 - When puncturing "jumbo" cans, remove white plastic sleeve from Aerosolv housing, then insert can as above.
- Lower sliding top plate and FIRMLY engage against plastic sleeve or bottom of "jumbo" can. TIGHTEN lock knob.
 - Push handle down firmly until completely depressed and hold in place while can releases initial pressure. Slowly raise the handle and immediately depress, this will control the rate of pressure and content evacuation from the aerosol can. In order to prevent back pressure, allow the contents of the can to drain into the collection drum (about 20 seconds).
 - After removing punctured can, lower sliding top to rest on plastic sleeve to seal collection drum. For "jumbo" cans, replace plastic sleeve prior to lowering sliding top plate.

AEROSOLV[®] FILTER

- Replace Activated Carbon Cartridge (upper portion) every 3 months or 750 cans; more frequent change-outs may be necessary based on use. Remove spent Activated Carbon Cartridge by turning counter-clockwise while holding in place Coalescing Cartridge (bottom portion). Replacement of the Activated Carbon Cartridge will prolong the life of the entire Combination Filter.
- Replace the entire Combination Filter every 9 months, 2250 cans, or after the Activated Carbon Cartridge (upper portion) is changed-out twice. To replace simply order a Combination Filter, which includes the Coalescing Cartridge and the Activated Carbon Cartridge

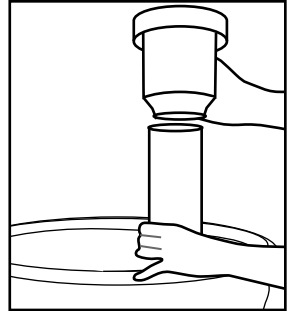

AEROSOLV[®] ANTI-STATIC WIRE

OSHA requires that liquid storage vessels be grounded to prevent static electricity build-up. The Aerosolv System includes an Anti-Static Wire for user convenience.

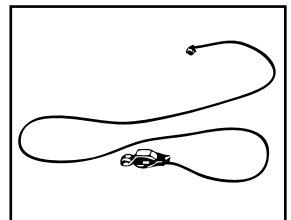

AEROSOLV® MAINTENANCE

Periodic cleaning and greasing of the puncture pin will assure years of use. With constant, heavy usage, the puncture pin should be cleaned and greased once a month.

- To clean or replace puncture pin, remove bridge pin at uppermost point of handle. Entire handle mechanism and puncture pin can be removed.

Gasket deterioration will occur when venting aerosol paints and aggressive solvents, requiring periodic gasket replacement. To assure proper seal during Aerosolv usage, check gaskets frequently and replace as required.

- To replace gasket, remove white plastic sleeve from Aerosolv housing, then simply pull out old gasket and snap in replacement.

COMPLIANCE

- *By bringing the propellant to atmospheric pressure, Aerosolv achieves compliance with:*
 - › 40 CFR 261.7(b)(1)
 - › 40 CFR 261.7(b)(1)(B)(2)
 - › 40 CFR 261.23(a)(6)
- *Once relieved of pressure, aerosol cans are not regulated waste (OSWER Directive 9432.01 (80)). In addition, puncturing aerosol cans to achieve atmospheric pressure **is not** considered "treatment"; therefore, permitting is not required.*

RECYCLING

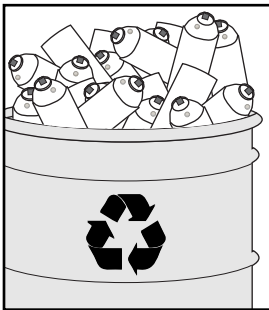

- Recycling 8,000 aerosol cans reduces solid waste and increases recycling by one-ton.
- By installing Aerosolv systems on two drums, non-chlorinated aerosols can be collected separately, then reclaimed as solvents, resulting in waste minimization credit.
- Cans punctured using Aerosolv may be recycled with other scrap steel.

Aerosolv leaves only a smooth edged hole.

CONSERVATION

With Aerosolv, conserve dollars while saving precious landfill space.

- Solid waste disposal of aerosol cans averages \$5/can.
- Fines for improper disposal can reach \$25,000.
- The cost of Aerosolv is recouped after puncturing as few as 100 cans.

#5000 Aerosolv Can Recycling System includes:

- Puncturing unit with separate plastic sleeve
- Anti-static wire
- Coalescing carbon filter
- Safety goggles

REPLACEMENT ACCESORIES FOR #5000



#6163

Combination coalescing/carbon filter



#6363

Carbon cartridges (2 pk)



#5165EX

Maintenance Repair Kit: includes puncture pin with o-rings, aeroprene gasket, bridge pins, spring and tube of grease



#5129

Aeroprene Gasket



KATEC®

1 (800) 843-6808

aerosolv.com

Appendix F: Photograph of a Typical Shale Bin



Photo of a typical shale bin

Appendix G: City of Winnipeg Letter with Wastewater Testing Results



RECEIVED

MAR 03 2016

Water and Waste Department • Service des eaux et des déchets

February 26, 2016

JASON HENKEL
GFL ENVIRONMENTAL WEST CORP.
1090 KENASTON BOULEVARD
WINNIPEG MB R3E 0R7

Document ID: IWSB-PP-877
NAICS Code: 562210

Sewer By-law No. 92/2010
Pollution Prevention Plan No Longer Required

Dear Jason Henkel:

Based on the analytical results from our inspection at 1090 Kenaston Boulevard on February 11, 2016, we no longer require GFL Environmental West Corp. to prepare and submit Pollution Prevention Planning documents.

Analysis of the sample we collected shows that your wastewater is within the limits set out in the Schedules of the by-law. Please see the attached table for the results of our analysis.

We will continue to periodically monitor the wastewater discharges from 1090 Kenaston Boulevard. If the discharges exceed any of the limits in Schedules A, B, C, and D, we will re-evaluate the requirement for GFL Environmental West Corp. to participate in the Pollution Prevention Planning Program.

Information on Pollution Prevention Planning, including form templates, is available on our website at winnipeg.ca/waterandwaste/sewage/pollutionprevention

If you have any questions, please contact one of our Pollution Prevention Program Inspectors.

Brett Zastre
Phone: 204-986-8407
Email: BZastre@winnipeg.ca

Jenny Khounnasene
Phone: 204-986-8350
Email: JKhounna@winnipeg.ca

Regards,



Meghan Marsland
Industrial Waste Services Branch Head
Environmental Standards Division

Wastewater Sampling Results

Company: GFL Environmental West Corp.

Sample Name: GRE 5

Sample Location: Holding Tank

Sample Type: Grab

Date Sampled: 11-Feb-16

Parameter	Sewer By-Law Limit (mg/L)	Sample Result (mg/L)	Comments
Aldrin / dieldrin	0.0002	<0.002**	
Aluminum (total)	50	<0.050	
Antimony (total)	5	<0.0020	
Arsenic (total)	1	<0.0020	
Benzene	0.5	<0.00050	
Biochemical oxygen demand*	300	71	
Cadmium (total)	0.7	0.00017	
Chlordane (cis plus trans isomers)	0.1	<0.002	
Chromium (hexvalent)	2	<0.01	
Chromium (total)	4	<0.010	
Cobalt (total)	5	<0.0020	
Copper (total)	2	0.0622	
Cyanide (total)	2	<0.0020	
1,1,2,2 Tetrachloroethane	1.4	<0.00050	
1, 2 - dichlorobenzene	0.05	<0.014	
1,4 - dichlorobenzene	0.08	<0.014	
3,3 - dichlorobenzidine	0.002	<0.014**	
Dichlorodiphenyltrichloroethane (DDT)	0.0001	<0.002**	
Cis - 1, 2 - dichloroethylene	4	<0.00050	
Ethyl benzene	0.16	<0.00050	
Fluoride	10	0.995	
Hexachlorobenzene	0.0001	<0.0014**	
Hexachlorocyclohexane (Lindane)	0.1	<0.001	
Lead (total)	1	0.00180	
Manganese (total)	5	0.0390	
Mercury (total)	0.01	<0.00020	
Methylene chloride	2	<0.0050	
Mirex	0.1	<0.001	
Molybdenum (total)	5	0.0037	
Nickel (total)	2	<0.020	
Nitrogen (total)*	60	55.2	
Nonylphenols	0.02	<0.001	
Nonylphenol ethoxylates	0.2	<0.002	
Animal or vegetable oil	100	10.1	

Wastewater Sampling Results

Company: GFL Environmental West Corp.

Sample Name: GRE 5

Sample Location: Holding Tank

Sample Type: Grab

Date Sampled: 11-Feb-16

Parameter	Sewer By-Law Limit (mg/L)	Sample Result (mg/L)	Comments
Mineral or synthetic oil	15	7.5	
Pentachlorophenol (PCP)	0.01	<0.018	
Phenolics (total by 4AAP method)	1	<0.50	
pH	5.5 to 11	7.71	
Phosphorus (total)*	10	4.89	
Polychlorinated biphenyls (PCBs)	0.001	<0.00030	
Polycyclic aromatic hydrocarbons (PAHs)	0.005	<0.034**	
Selenium (total)	1	<0.010	
Silver (total)	5	<0.0010	
Sulphate (total)	1500	58.4	
Sulphide	1	<0.020	
Suspended Solids (total)*	350	25.0	
Tetrachloroethylene	1	<0.00050	
Tin (total)	5	<0.0020	
Titanium (total)	5	<0.0050	
Toluene	0.024	0.00051	
Total Purgeable Hydrocarbons	10	<0.10	
Total Semivolatile Hydrocarbons	100	4.07	
Trichloroethylene	0.4	<0.00050	
Xylenes (total)	1.4	<0.0015	
Zinc (total)	2	0.058	

Notes: * - Discharges exceeding these limits may be eligible for inclusion into the overstrength wastewater discharge program.

** - Detection limit greater than By-law limit due to matrix effects.

Appendix H: GFL Liquid Waste West Spill Prevention and Containment Procedure &
Winnipeg Emergency Response Plan

		<h1>Spill Prevention and Containment Procedure</h1>	
Site: Corporate		Document ID: GFL-EHS-COR-044-PR	
Author: Compliance Manager		Category: Procedure	
Approver: General Manager		Approval Date: June 3, 2015	Rev. No.: 0
Document Location (Edmonton office): Public(P:)/Compliance/Safety, Policy, Procedure/Policy Docs –pdf FINALS/Policy FINALS			

1.0 PURPOSE

GFL is committed to the prevention and containment of spills. Policies regarding Environmental protection in place today are a clear illustration of GFL's continued commitment to reduce the risks inherent in the transportation, processing, storage and handling of hazardous and non-hazardous recyclables and wastes.

The GFL Spill Prevention and Containment Procedure has been developed to establish requirements for facilities and for handling and transporting wastes and recyclables at customer sites or on the road in order to protect the public, the environment and personal property.

2.0 SCOPE

This Procedure applies to all GFL Environmental Inc., Liquid Waste West locations and employees involved in the transportation, processing, storage and handling of wastes and recyclables.

3.0 RESPONSIBILITIES

3.1. General Manager

- Makes appropriate resources available to ensure that the Spill Prevention and Containment Procedure (GFL-EHS-COR-044 PR) can be implemented and will be effective.
- Authorizes the mobilization of emergency responders and remediation contractors.
- Authorizes the mobilization of GFL personnel to the scene for incident assistance and/or remediation efforts.
- Contact person for all media inquiries.
- Acts as the primary liaison between GFL senior management and the Operations Managers.

3.2. Compliance Manager

- Contacts authorities to report spills, as required.
- Completes a follow-up report as required by regulatory authorities.
- May provide technical advice including: safe work instructions, personal protective equipment (PPE) requirements, isolation and evacuation distances, and expected remedial measures.

3.3. Operations Managers

- Detailed knowledge of the contents and required response under this Spill Prevention and Containment Procedure.
- Receives verbal/electronic notice of spills and provides advice, as required to contain, cleanup and remediate any spilled material.

Hardcopies of this document are uncontrolled and may be assumed current only at the time of printing.

- Leads and is responsible for all written reporting and investigation to complete reporting requirements to the GFL Compliance Manager/ General Manager using GFL-EHS-COR-002-FI Incident Investigation Report Form.
- Inspects and reviews all storage devices, transportation equipment, employee training and containment to ensure all equipment, vehicles, storage devices, staff and containment are serviceable, able to operate effectively and meet the standards as required to operate under existing approvals and licensing

3.4. Employees

- Report all spills to the Operations Manager using GFL-EHS-COR-002-FI Incident Investigation Report Form.
- Report all equipment, vehicle, storage device and containment deficiencies to their immediate supervisor immediately.
- Follow prevention and containment measures within this document and as required at client sites.
- Report conditions that may lead to drips, leaks or spills to the supervisor and/or address immediately.
- Cleanup minor leaks when they happen.
- Cleanup spills when they occur.

4.0 DEFINITIONS

None

5.0 PROCEDURE

5.1 General

Each GFL site must have and maintain its own Emergency Response Plan covering all reasonably foreseeable emergencies including spills. These Plans must be reviewed and a scenario practiced annually by employees at each site.

GFL sites must be regularly inspected including the inspection of storage, handling and processing areas as per GFL-EHS-COR-042-WI Facility Inspection Work Instructions. Vehicles and trailers must be inspected each day of use. Spill response materials or spill kits must be readily available in the event of a spill and the contents of the kits must be periodically assessed to ensure the availability of adequate spill response supplies. Leaking containers, equipment drips, and conditions that could lead to leaks or spills must be reported to the supervisor and/or addressed immediately. Missing items such as spill cleanup materials and drip trays must be reported to the supervisor and/or replaced immediately.

Bulk liquid trucks carrying hazardous recyclables and wastes have their bulk storage tanks inspected annually. Hoses with the truck are pressure tested at the same time (annually). Hoses must be visually inspected at each use and any hoses with broken/missing camlocks or excessive wear are not used. Truck hoses must be replaced if they fail testing and truck tank issues must be repaired. A pre and post trip inspection is done on all trucks as per GFL-OPS-COR-002-PR Driver Procedure. Issues found must be repaired as necessary.

5.2 Bulk Storage

Bulk storage tanks holding hazardous recyclables or wastes at GFL facilities must be either double-walled or have suitable containment. During transfers into or out of GFL bulk storage tanks, hose

Hardcopies of this document are uncontrolled and may be assumed current only at the time of printing.

leaks must be contained by the use of a truck containment pad or spill trays or both. During transfers, employees are required to remain with the truck in order to quickly stop a transfer in case of a spill. Spill clean-up materials are located adjacent to transfer areas on GFL sites as well as on every truck.

When transferring into or out of client tanks, spill containment provided is used. GFL recommends additional spill containment to clients if it is believed it will assist the client to maintain a spill-free site.

Employees clear hoses prior to disconnecting them. Hoses must be in good condition, including connections.

5.3 Vacuum Trucks

When vacuum trucks are used to remove liquids from small containers (e.g.: drums) so they can be bulked into tanks, the activity is done within a building that is covered and having sloped floors and/or containment curbs.

5.4 Sludge Treatment

Sites handling sludge for stabilization have either sealed concrete cells or sealed metal bins used to hold sludge before treatment. Bins have a concrete approach to catch any drips. Truck unloading into the sludge cell or bin, must be assisted in getting as close as possible (by the use of curbs or a spotter) in order to avoid unnecessary splashing.

Free liquid from sludge is collected into a sump, holding tank/tote or a vacuum truck to be treated further before disposal or directly disposed of offsite at an approved disposal facility.

Sludge is treated by adding wood chips and/or sawdust while it is in the contained bin or cell. Once stabilized, the solid, granular material is put into dump trucks for disposal offsite at an approved landfill facility.

5.5 Drums, Totes and other Small Containers

When containers are loading onto trucks, the load must be secured from movement prior to moving the truck. Damaged containers may be refused if they appear likely to leak. Alternatively, over pack drums may be used or else the contents transferred to a container in good condition (dependant on client wishes). GFL trucks do not carry incompatible materials in the same shipment. Labels must be checked prior to loading and unlabeled container must be verified and re-labeled before loading.

Containers collected inside trailers at GFL satellite sites must be regularly checked as being in continuous good condition until they are transferred to a GFL processing site.

When a shipment of containers is offloaded at a GFL site for processing, it is offloaded into a building with sloped floors and/or containment curb(s) to catch any spills. Incompatible materials must be segregated from each other. All containers have their labels checked again when offloaded. Employees must be trained in safe drum and tote movement.

5.6 Solid Waste Bins

Solid waste bins on GFL sites must be properly sealed with plastic lining if they may have any free liquids and they must be covered to prevent precipitation accumulation if containing hazardous recyclables or waste.

Hardcopies of this document are uncontrolled and may be assumed current only at the time of printing.

5.7 Processing Areas

Processing areas such as where oil filters are crushed, aerosol cans are drained, and similar activities where free liquids may be present, must be sloped and/or have containment curbs. Floor washings go into a sump that is periodically emptied and the contents disposed of to an approved disposal facility. If a large spill occurs, the sump contents must be tested to determine proper disposal.

6.0 TRAINING

Employees performing the tasks described in this procedure must be provided an orientation (see GFL-HRP-COR-007-PR Orientation Procedure) as well as on-the-job training. They are not allowed to work on their own until they have demonstrated proficiency and competency.

7.0 RECORDS RETENTION AND DESTRUCTION

This Procedure shall be maintained electronically in the location noted in the header on the first page under "Document Location(s)". At least one previous revision shall be retained and archived. Older revisions are to be erased and all hard copies destroyed by disposal in the garbage or shredding.

8.0 ASSOCIATED DOCUMENTS

None

9.0 REFERENCES

- 9.1 GFL-EHS-COR-002-FI Incident Investigation Report Form
- 9.2 GFL-EHS-COR-042-WI Facility Inspection Work Instructions
- 9.3 GFL-HRP-COR-007-PR Orientation Procedure
- 9.4 GFL-OPS-COR-002-PR Driver Procedure

		Winnipeg (Kenaston) Emergency Response Procedure	
Site: Winnipeg (Kenaston)		Document ID: GFL-OPS-WIN-001-PR	
Author: Compliance Manager		Category: Procedure	
Approver: General Manager		Approval Date: June 1, 2016	Rev. No.: 2
Document Location (Edmonton office): Public(P:)/Compliance/Safety, Policy, Procedure/Policy Docs –pdf FINALS/Policy FINALS			

NOTE: This Emergency Plan also serves as the site’s FIRE SAFETY PLAN for GFL Environmental Inc. located at 1090 Kenaston Boulevard, Winnipeg, Manitoba.

1.0 PURPOSE

This procedure establishes the actions to be taken when there is an emergency situation at the Winnipeg (Kenaston) facility.

2.0 SCOPE

This procedure applies to GFL Environmental Inc., Kenaston site in Winnipeg, Manitoba.

3.0 RESPONSIBILITIES

3.1 General Manager

The General Manager assists the ERC and provides guidance and direction on behalf of the company to manage risk and liability. He also provides all information towards media inquiries.

3.2 GFL Manitoba Operations Manager

It is the responsibility of the Manitoba Operations Manager to:

- administer, review and maintain this site-specific Emergency Response Plan.
- designate employees for emergency response duties as needed.
- incorporate emergency response requirements into Work Instructions, as applicable.
- act as or designate an Emergency Response Coordinator (ERC) during an emergency
- act as the Safety Officer and designate another person when not available.

3.3 Employees, Visitors, and Contractors

This includes Contractors and Employees involved in emergency response.

Employees and Contractors are required to report spills as per GFL-EHS-COR-002-PR Incident Investigation and Reporting Procedure.

Workers responding to site emergencies must use the emergency response equipment and PPE supplied for dealing with site emergencies.

All employees, contractors and visitors must sign in/out at the office.

Hardcopies of this document are uncontrolled and may be assumed current only at the time of printing.

Employees, visitors, and contractors must follow instructions from the Winnipeg Operations Manager or designate.

3.3 Emergency Response Coordinator (ERC)

The acting ERC must consider the following, in order:

- The safety of themselves
- The safety of employees, visitors and contractors (including those requiring rescue),
- The safety of the general public,
- The protection of the environment,
- The protection of company property.

The ERC is responsible for the following in the event of an emergency in their jurisdiction:

- Collection of information from the attending driver or operator reporting the incident;
- Immediate emergency response direction to GFL employees as necessary to protect human health and the environment and/or minimize the impact of the event;
- Communication of information to the General Manager;
- Reporting of the incident to the provincial authorities, as applicable;
- Supervising remediation efforts to the satisfaction of the provincial authorities, as applicable;
- Completing an internal review and investigation after each emergency event including documenting the cause and any corrective and preventative measures taken to ensure it does not occur again.

3.4 Compliance Manager

Assist the Manitoba Operations Manager with external reporting and incident investigation, as needed.

4.0 DEFINITIONS

4.1 Contractor

A Contractor is a non-GFL worker hired to do work either in the office or operating areas. Contractor includes Carrier drivers.

5.0 PROCEDURE

5.1 General

Legal Description: Lot 3, Plan 9153, WLTO in OTM Lots 60 to 63, Parish of Saint Boniface

The site is located at 1090 Kenaston Blvd. in Winnipeg, Manitoba.

The Winnipeg Facility consists of a main tank farm with 13 tanks, a process tank farm with 4 tanks, a 7960 ft² filter shop area, an indoor oil processing area with 4 tanks, a 4000 ft² wastewater treatment building with 11 tanks and a Cetco water treatment system, a sludge bin, solvent tank and a 4000 ft² office building. All buildings onsite are single story buildings. The larger of the two tank farms (main) contains twelve (12) 120,000 liter tanks and two (2) 640,000 liter tanks. The smaller tank farm (process) consists of four (4) 60,000 liter steel tanks. The indoor oil processing area has four (4) 15,000 liter tanks. The wastewater treatment building has six (6) 10,000 liter tanks and five (5) 20,000 liter tanks. The solvent tank has a 1000 liter capacity and the sludge bin

Hardcopies of this document are uncontrolled and may be assumed current only at the time of printing.

has a 48,000 liter capacity. All tanks are aboveground, and either double-walled or have containment.

A hardcopy of this ER Plan must be maintained in the lunchroom for availability to all employees.

If there are changes to the site which impact how Emergency Response is carried out, this procedure must be revised or amended, as appropriate.

The General Manager and the Compliance Manager will review all emergency incident reports and follow-up with the Manitoba Operations Managers to ensure appropriate corrective actions have been taken to prevent reoccurrence.

Walkways, stairs and doorways will be kept unobstructed in the event of an emergency. All the phone numbers provided throughout the document are summarized in Appendix B.

Approximately every 2 years, the local Fire Department will be sent an invitation to tour the site and better understand the identified potential emergency situations.

5.2 Wastes and Recyclables Onsite

Refer to Appendix A for an overview of materials onsite and the site layout.

5.3 Potential Emergencies

Based on materials handled at the site and historical occurrences and activities, the following potential emergency conditions have been identified:

- Fire/explosion
 - involving main office building structure
 - involving outbuilding
 - involving oil or fuel/solvent
 - involving natural gas utility piping onsite
 - involving combustibles (e.g.: oily rags, spill cleanup material, wooden pallets, etc.)
 - involving an offsite, utility gas pipeline
- Spills
 - involving oil or fuel/solvent from bulk or drummed waste
 - involving corrosives from drummed waste
 - involving oxidizers from drummed waste
- Release
 - involving flammable gas from a non-GFL adjacent pipeline
- Injury
- Severe weather causing:
 - Tornado
 - Flooding
- Workplace Violence situation
- Evacuation

In the event that the site performs unusual activities such as confined space entry, construction, demolition, etc., the Manitoba Operations Manager shall perform a hazard assessment (see GFL-EHS-COR-005 Hazard Assessment Procedure). The hazard assessment must address the potential for additional emergency situations (e.g.: rescue) and how they will be addressed.

Hardcopies of this document are uncontrolled and may be assumed current only at the time of printing.

5.3.1 Fire/Explosion

An explosion, fire or flood must be reported to Manitoba Workplace Safety and Health Division at 1-204-945-3446 OR 1-866-888-8186 [inside MB only] OR 1-204-945-0581 [after hours] whether there is an injury or not.

5.3.1.1 Fire/Explosion Involving the Main Office Building Structure

A fire/explosion in the main office building/structure could result from:

- Arson (after hours)
- Fire/explosion in the Winnipeg (Kenaston) Shop area
- Ignition of combustibles (space heater, kitchen fire, electrical fault, etc.)

An after-hours fire may be noted by the nearby, 24 hour A&W or one of their patrons. Alternatively, it may be detected by an employee working overtime in the building, shop or yard.

The main concern of a fire in the main office building is potential employee injury as this building is occupied during normal business hours. Fire extinguishers are provided around the building, strategically placed towards exits. Depending on the conditions and if an employee was onsite at the time, an attempt to put the fire out with a fire extinguisher should be attempted, if safe to do so.

In the event of a fire inside the building which is not successfully put out by a fire extinguisher, all persons except the Safety Officer shall exit the building to the muster point just outside the gate on the north side of the parking lot. They are to remain there until the Safety Officer arrives and completes a headcount, and the fire department has said it is safe to return to the building or to leave.

The Safety Officer or designate retrieves the employee time cards from the drivers' room and the contractor sign-in sheet at the front reception desk. He checks offices, lunchroom, boardroom and washrooms for anyone left behind, and assists them as necessary. He closes doors behind him as he exits and goes to the muster point. The contractor sign-in sheet and timecards are used to perform a headcount. Any unaccounted for individuals will be reported to the Fire Department upon their arrival. The Safety Officer shall assign someone to close the main gas valve on the south west corner of the office building if it is safe to do so.

If any person is trapped in the office building during a fire, they should close (but do not lock) the door and seal door cracks with anything available to reduce smoke. They then should crouch down, getting their breathing zone close to the floor.

The main office building area is equipped with 2 smoke detectors: one in the lunchroom and one in the reception area. Smoke alarms will automatically sound at the site if smoke is present.

5.3.1.2 Fire/Explosion Involving Outbuildings

The only outbuildings at the Kenaston site are the Wastewater Treatment Building and a small pump house at the tank farm.

In the event of a fire involving this building the main concern is to minimize damage and prevent the fire from spreading. This building is not normally occupied. Depending on the conditions and if during regular business hours, an

attempt to put it out with a fire extinguisher can be attempted, if safe to do so.

5.3.1.3 Fire/Explosion Involving Oil or Light Fuel/Solvent

A fire/explosion involving oil, fuel or solvent could result from a heat or ignition source being present nearby after a spill.

Depending on the conditions, an attempt to put it out with a fire extinguisher should be attempted, if safe to do so. Alternatively or in addition, dirt may be used to smother the fire and/or contain it.

The employee would then attempt to stop the spill if possible and safe to do so. Otherwise, they would contact the Winnipeg Fire Department and go to the muster point in the parking lot of the office building to await help from the Fire Department.

5.3.1.4 Fire/Explosion Involving Natural Gas Utility Piping Onsite

Natural gas is supplied to the site by Manitoba Hydro. The gas supply comes into the site on the west side and the main gas shut-off valve is located outside the southwest man door of the main office building (see “Winnipeg (Kenaston) Office Building” layout in Appendix A). In the event of a natural gas leak and fire onsite, the main gas shutoff could be closed and then a gas fitter would be hired to repair the leak or Manitoba Hydro can be contacted.

Manitoba Hydro (24/7) (204) 480-5900 (in Winnipeg)
(888) 624-9376 (outside Winnipeg)

If another situation involving natural gas leak and fire occurred and it could not easily be resolved, the Winnipeg Fire Department would be notified, Manitoba Hydro would be notified and employees would be moved a safe distance from the site as necessary.

5.3.1.5 Fire/Explosion Involving Combustibles Onsite (oily rags, wooden pallets, etc.)

A fire involving combustibles onsite would be handled very similarly to one involving the office building, except that there should be few to no people in the area to evacuate.

In the event of a fire involving combustibles the main concern is to minimize damage and prevent the fire from spreading. Depending on the conditions and if employees were onsite at the time, an attempt to put it out with a fire extinguisher should be attempted, if safe to do so. Alternatively or in addition, dirt may be used to smother the fire and/or contain it.

5.3.1.6 Fire/Explosion Involving an Offsite, Gas Pipeline

There are underground gas pipelines running along the west property boundary. Manitoba Hydro owns and operates these pipelines. It is possible that there could be a leak either due to pipeline damage, corrosion or wear. A gas pipeline leak could be ignited by a vehicle or other ignition source. In the event of a gas leak and fire/explosion, the Winnipeg Fire Department would likely initiate an evacuation

The following emergency numbers can be contacted to inform or inquire about the emergency:

Manitoba Hydro (24/7) (204) 480-5900 (in Winnipeg)
(888) 624-9376 (outside Winnipeg)

Employees will be dispatched in an orderly manner from the site and in a safe direction away from the fire.

The employee involved in or discovering any fire (except one occurring offsite) must initiate a GFL-EHS-COR-002-F1 Incident Investigation Report Form. The completed Incident Investigation Report Form must be filed with the ERC in a timely manner after the occurrence.

5.3.2 Spills

An uncontrolled spill or escape of a hazardous substance must be reported to Manitoba Workplace Safety and Health Division at 1-204-945-3446 OR 1-866-888-8186 [inside MB only] OR 1-204-945-0581 [after hours] whether there is an injury or not.

5.3.2.1 Spill Involving Oil, Fuel or Solvent from Bulked or Drummed Waste

A spill of fuel or oil could occur after a number of different incidents such as:

- Hose or piping failure
- Vehicle collision causing tanker damage
- Leak from a tank
- Over filling a tank or truck
- Drum knocked over and damaged
- Drum leak

In the event of a spill, the employee shall use the spill clean-up materials kept onsite in the loading area or the drum storage area, if it is safe to do so. Then the spill quantity and conditions will be checked against the quantities list in Table 1.

Note that a spill in Manitoba is not reportable to authorities if it falls inside containment or is on an impervious surface such as concrete, a dike liner, or roadway AND the liquid spilled is not volatile or giving off vapours.

Table 1: Immediate Reportable Spill Quantities

Substance Spilled or Released	Federal TDG	MB
Class 2.1 (flammable gas)	Any amount that could pose a danger to the public or last ≥ 10 min	100 L
Class 2.2 (compressed gas)		Any amount
Class 2.3 (toxic gas)		
Class 2.4 (corrosive gas)		
Class 3 (flammable liquid)	200 L	100 L
Class 4 (flammable solid)	25 kg	1 kg
Class 5.1 (oxidizer)	50 L or 50 kg	50 L or 50 kg
Class 5.2 (organic peroxide)	1 L or 1 kg	1 L or 1 kg
Class 6.1 (toxic)	5 L or 5 kg	5 L or 5 kg
Class 8 (corrosive)	5 L or 5 kg	5 L or 5 kg
Class 9 (miscellaneous)	25 L or 25 kg	50 kg - misc. Class 9.1, 500 g - PCBs, 1 kg - aquatic toxics, 5 kg - chronic toxics
Waste oil/oil	Only if causing harm	100 L (see 45 of license)
ANY substance entering a watercourse or causing harm	Any amount	Any amount
Anything	N/A	>5 L and <100 L must report within 1 working day (see 46 of license)

Hardcopies of this document are uncontrolled and may be assumed current only at the time of printing.

NOTE: Spill reporting is very time sensitive.

Delayed reporting to authorities can create a situation for a non-compliance or fine.

In the event of a reportable spill occurrence as defined in Table 1, the employee at the scene shall immediately contact regulatory authorities directly OR contact the Manitoba Operations Manager. The Manitoba Operations Manager must either contact provincial authorities himself or request assistance from the Compliance Manager or the General Manager.

In the event of a critical equipment failure such as a drain valve malfunction resulting in the loss of a significant volume of waste oil or fuel/solvent within the tank farm containment system, as much liquid waste as practical should be recovered from the floor of the diked area using a pump and/or vacuum truck(s). Once the majority of the free liquid has been recovered, and only residual waste oil remains, clean, potable water should be pumped into the tank farm containment system and a surfactant added to promote the release of the remaining liquid waste for skimming and collection (during warm weather months). Pressure washers and steamer units may also be employed to wash the liner and aggregate free of residual oil (especially in colder months). All residual water shall be managed and disposed of as oily water according to the Manitoba Dangerous Goods Handling and Transportation Act.

Truck Off-Loading Containment

All GFL tank trucks are equipped with drive-line actuated mechanical gear pumps with rear pressure relief systems. All hoses are specified to meet or exceed petroleum handling requirements and are rated for a maximum operating pressure of 150 psi. All truck gear transfer pumps are set to 80 psi as a safety factor to prevent the possibility of rupturing a transfer hose. All pumps can be shut down from the cab of the vehicle, or by controls mounted outside the vehicle in plain view of the connections and valves.

Tank Farm Protection Systems

The Main Tank farm (larger of the two tank farms) is provided with a 1.2m x 15m x 35.5m concrete wall containment area. The floor of this area is lined with rubber, which is covered with 2.5 to 5 cm of gravel. This secondary containment was sized to meet National Fire Code requirements, which require the volume of containment meet 110% of the volume of the largest tank plus 10% of the aggregate volume of all other tanks. Based on these criteria, the volume requirement is 837 cubic meters. The dike provides a capacity of 840 cubic meters, not taking in to account the displacement of the tanks within the containment.

The Process Tank farm (smaller tank farm) consists of four 60,000 L steel tanks within an 11.0m x 14.78m x .080m concrete containment cell. The tanks are 3.5m in diameter and the north-west corner of the containment has an open shed (not sealed off from the rest of the containment at all). The total available secondary containment is 99,200 L, which is greater than the 78,000 L required by the National Fire Code. This containment cell does not have a rubber liner above the concrete, but it does utilize a 2.5 to 5 cm layer of fine gravel to capture small spills.

Hardcopies of this document are uncontrolled and may be assumed current only at the time of printing.

There are also four process vessels located inside the Winnipeg Shop process area. Each tank has a hopper bottom to facilitate collection and removal of solid generated during processing. The design of the floor and plant drainage systems ensures that no releases of liquids can escape outside the building. The floor slopes towards a centrally-located drain (sump) which discharges to a containment sump (septic tank) at the south-west corner of the facility. The sump and floor area have more than sufficient capacity to contain 110% of any of the four (4) 15,000 L process tanks.

The solvent tank is a double-walled tank set on a concrete pad. This double-walled tank has barrier protection (e.g.: New Jersey barriers) to prevent collision by a vehicle.

The fuel tank near the sludge tank inside the Shop has secondary containment to provide 110% containment.

The employee involved in or discovering the spill must initiate a GFL-EHS-COR-002-F1 Incident Investigation Report Form. The completed Incident Investigation Report Form must be filed with the ERC in a timely manner after the occurrence.

5.3.3 Release of Gases/Vapours

An uncontrolled spill or escape of a hazardous substance must be reported to Manitoba Workplace Safety and Health Division at 1-204-945-3446 OR 1-866-888-8186 [inside MB only] OR 1-204-945-0581 [after hours] whether there is an injury or not.

5.3.3.1 There are some underground gas pipelines that run along the west property boundary which could leak or rupture. There is also a possibility of a gas release from a truck involved in an accident as Kenaston is a full-time truck route and Dangerous Goods are routinely moved through the area (Winnipeg Truck Routes map:

<http://www.winnipeg.ca/publicworks/PDF/Transportation/truckroutemap.pdf>)

In the event of a flammable gas leak, the best recourse is shutdown ignition sources and to shelter-in-place, meaning to stay inside a building and seal windows and doors as best as possible. The HVAC shutoff to stop air intake into the main office building is located on the roof and can be access by the ladder in on the side of the north office building.

The Winnipeg Fire Department would likely initiate shelter-in-place for all area businesses. The following emergency numbers can be contacted to inform or inquire about the emergency:

Manitoba Hydro (24/7) (204) 480-5900 (in Winnipeg)
(888) 624-9376 (outside Winnipeg)

In the remote but possible event of a toxic gas (e.g.: ammonia, chlorine, hydrogen sulphide, etc.) leak from a damaged truck on a nearby roadway, and depending on circumstances, the best recourse is likely to shelter-in-place. The site would likely not be aware of the event unless notified by the Winnipeg Police or Fire Department. However, if necessary and safe to do so, the intake fan for the HVAC unit on top of the Office building can be shutdown by

accessing it from the ladder on the north side of the building. Employees should then use towels or spill cleanup materials to block cracks in doors or windows and remain inside the building until told it is safe by Police or Fire personnel.

5.3.4 Injury

The following injuries must be reported to Manitoba Workplace Safety and Health Division at 1-204-945-3446 OR 1-866-888-8186 [inside MB only] OR 1-204-945-0581 [after hours] whether there is an injury or not:

1. an accident in which a worker is killed,
2. an accident in which a worker suffers:
 - a. an injury resulting from electrical contact,
 - b. unconsciousness as the results of a concussion,
 - c. a fracture of his/her skull, spine, pelvis, arm, leg, hand and/or foot,
 - d. amputation of an arm, leg, hand, foot, finger or toe,
 - e. third degree burns,
 - f. permanent or temporary loss of sight
 - g. a cut or laceration that requires medical treatment at a hospital as defined in the Health Services Insurance Act, or
 - h. asphyxiation or poisoning, or
3. the failure of an atmosphere-supplying respirator

In the event of a serious injury, an ambulance would be summoned (dial 911) and it will be reported immediately to the ERC. If a first aid provider is present, they would provide care to the injured individual until the ambulance arrives. It takes approximately 15 minutes for an ambulance to arrive from within Winnipeg.

If an employee is alone at the site and becomes injured or ill, GFL has a Working Alone Procedure (GFL-EHS-COR-024-PR) which describes how employees are accounted for. Essentially, employees check in with their supervisor at various times during the day. In the event an employee working at the Winnipeg facility or out of the Winnipeg facility was unaccounted for, the Winnipeg Police Service would be contacted and/or the ERC would dispatch someone to the site.

The employee involved in or discovering the injury/illness must initiate a GFL-EHS-COR-002-F1 Incident Investigation Report Form. The completed Incident Investigation Report Form must be filed with the ERC in a timely manner after the occurrence.

5.3.5 Severe Weather

The City of Winnipeg operates a webpage where anyone can sign-up for automatic emergency notifications, such as for severe weather:

http://www.winnipeg.ca/wpgmail/subscribe_all.stm?elist=1#city

Severe weather alerts can also be checked by going to the Environment Canada website at: <http://weather.gc.ca/warnings/> .

The Manitoba Operations Manager has signed up for this service and would notify affected employees in the event of a severe weather warning.

5.3.5.1 Tornado

Manitoba is prone to tornados. Winnipeg has suffered tornados in the past. The threat of injury due to a tornado is very real should one strike when employees are on site. The threat of damage and damage creating a spill onsite is also present.

In most circumstances, warning of severe weather will be received from City of Winnipeg automated email (see previous) or through the radio. Management will determine if severe weather warnings warrant releasing people to go home or to a safer location.

Weather indicating a possible tornado approaching includes:

- A dark or green-coloured sky,
- A large, dark, low-lying cloud,
- Large hail, or
- A loud roar that sounds like a train

Many times, the funnel cloud cannot be seen due to rain or clouds.

In the event of a tornado warning while an employee is on the road, they shall listen to the radio to determine safe routes of travel or whether to travel at all.

In a Structure

The outbuildings (pump house and washer fluid building) and Shop areas at the Winnipeg site are not well-suited for protection from a tornado and should be avoided as should all rooms/offices with exterior windows. Drivers on the road should avoid mobile homes, work trailers, buildings with many windows, and long-span buildings (e.g.: gymnasiums, shopping malls, theatres, etc.) as they offer little protection.

In the event a tornado gave little warning of possibly hitting the Winnipeg site, an employee would be dispatched to close the emergency gas shutoff valve to the site on the south west side of the main office building (see “Winnipeg Office Building” layout in Appendix A). Then employees would gather in the safest place in the office building which is the most interior office or just outside this room. The use of clothing, blankets, etc. for protection should be used if available.

On the Road

If there are no suitable structures available, a protected area such as under one end of an underpass, inside a culvert, under a one end of bridge, or in a lower-lying ditch can offer protection. Employees must not shelter themselves under their vehicle. Employees must not try to out-run the tornado or remain inside their vehicle. Areas with many trees must be avoided. Employees should use their arms, and anything else available to protect their head and neck. Manitoba Infrastructure and Transportation offers information on road conditions by calling 511 (within Manitoba) or by going to the following website: <https://www.gov.mb.ca/mit/roadinfo/index.html>

5.3.5.2 Flooding

An explosion, fire or flood must be reported to Manitoba Workplace Safety and Health Division at 1-204-945-3446 OR 1-866-888-8186 [inside MB only] OR 1-204-945-0581 [after hours] whether there is an injury or not.

Winnipeg sits in an area known for flooding (Red River). Flood conditions are routinely updated on the Manitoba Flood Information and Updates website:

<https://www.gov.mb.ca/mit/floodinfo/index.html>

In the event of heavy rains or information suggesting possible flooding, employees shall listen to the radio to determine safe routes of travel.

At the Site

In the event of possible flooding at the site and an employee is present, they should shut down electrical panels if it is safe to do so. Also, any loose items around the site should be secured inside one of the buildings. Product volume in the tanks should be reduced if safe to do so.

On the Road

In the event of flash flooding, high river/creek levels or general flooding when an employee is on route to the Winnipeg site or while leaving it, employees shall avoid underpasses, crossing bridges over swelled rivers/creeks, and roads completely covered in water of an unknown and possible unsafe depth. If a vehicle stalls in a flooded area, the employee shall leave the vehicle and get to safety. Manitoba Infrastructure and Transportation offers information on road conditions by calling 511 (within Manitoba) or by going to the following website:

<https://www.gov.mb.ca/mit/roadinfo/index.html>

5.3.6 Workplace Violence Situation

Because the Winnipeg site sees a lot of traffic and contractors, it is possible that an employee could encounter a situation with an annoyed and violent person while conducting operations. It is also possible drivers could encounter disgruntled customers while on the road. Possible situations include:

- An upset contractor or customer,
- A disgruntled neighbour or customer, or
- A criminal (e.g.: theft)

If an employee is approached by a potentially violent and/or abusive person while at the site or on the road, they should remain calm and try to position themselves so there is something between themselves and the other person (e.g.: a vehicle, piping, etc.). The employee should try to remove themselves from the situation if at all possible and report the incident once safely away.

Persons working in the Office building after hours or otherwise alone are to keep the door locked until at least one more employees arrives. Keys are issued for those persons who may access the building early, stay late or be there after hours.

The site has 16 security cameras mounted around the site. The cameras are used to track movement as well as act as a deterrent.

In the event of an injury due to the situation, the employee should follow the requirements in GFL-HRP-COR-008 PR, Workplace Violence and Harassment Policy.

5.3.7 Evacuation

In the event that local police or Fire Department issues an evacuation alert or if an offsite emergency (e.g.: gas pipeline leak, etc.) occurs and threatens the site, any employee at the Winnipeg site will leave the site checking wind direction as needed. If no immediate danger, the employee(s) will double check that tank valves, buildings and side gate are secured closed with a lock before leaving the site.

5.3.8 Other Emergencies

The collapse or structural failure of a building, structure, crane, hoist, lift, temporary support system or excavation, or must be reported to Manitoba Workplace Safety and Health Division at 1-204-945-3446 OR 1-866-888-8186 [inside MB only] OR 1-204-945-0581 [after hours] whether there is an injury or not.

5.4 Mustering

Mustering point is located at the north gate entrance.

If an emergency occurs which requires mustering, individuals shall check wind direction by looking at trees, smokestacks, flags or something similar, and then move upwind to the mustering point. If the designated muster point cannot be safely reached, the individual shall go to an alternate location and contact their supervisor/manager by cell phone to indicate their location. If they do not have a cell phone, they should remain where they are until emergency responders arrive and flag them down to indicate their presence.

In the event that an emergency situation occurs where employees gather at a muster point, the following procedures will be followed:

The last person leaving the main office building will take the sign-in sheet. A headcount of who is present at the muster station will be compared to the sign-in sheet/board. Missing individuals will be immediately reported to emergency responders when they arrive.

5.5 Location of Emergency Equipment

See the site layouts in Appendix A

5.5.1 Fire extinguishers

All trucks are equipped with fire extinguishers and they are also located:

- In the workshop
- In the de-ashing process area
- Inside the pumphouse of the Process Tankfarm
- West side outside the dike of the Process Tankfarm
- 2 at the west and east sides of the truck loading area
- Inside the main entrance to the office building
- Inside the entrance to the storage room of the main office building
- On the southwest corner of the Wastewater Treatment Building
- On the southeast corner of the Wastewater Treatment Building
- On the northwest corner of the Wastewater Treatment Building

Fire extinguishers are serviced annually by Bison Fire Protection (204-237-3473).

Hardcopies of this document are uncontrolled and may be assumed current only at the time of printing.

5.5.2 Spill Clean-up Equipment

All trucks are equipped with spill clean-up supplies and there are also supplies located:

- In the northwest corner of the de-ashing process building
- The northeast corner of the workshop
- The Southwest corner of the pumphouse
- The west side of the loading area
- In the storage room of the main office building
- The Southeast corner of the Wastewater Treatment Building

5.5.3 First aid kit

All trucks are equipped with first aid kits and there is also one located in the hallway of Main Office, outside the washrooms.

5.5.4 Eye wash station

An eyewash station is located on the west wall of the de-ashing process area and in the Shop.

5.5.5. Emergency Lights

Emergency lights are located:

- In the office area near the entrance to the shop next to the lunchroom, and
- In the shop above each man door to the outside.
- Above the south man door of the Wastewater Treatment Building

5.6 Drills and Exercises

The Manitoba Operation Manager will schedule a mock exercise (with assistance from the Office Manager) at least every three years involving employees working at and out of the Winnipeg (Kenaston) facility. The drill will test that the employees respond to the emergency, if the employees know where the muster points are and if they know how to respond for different emergencies.

Each year between the mock exercises, the Manitoba Operations Manager will go over a tabletop exercise for one of the possible emergencies and review with employees what actions need to be taken. This may be done at a safety meeting. At least a few Administrative staff shall be included whenever possible.

In the event that an actual emergency situation occurs, the mock exercise or tabletop exercise can be omitted for that year.

All mock exercises, tabletop exercises or actual events shall be evaluated as successful or needing improvements. This evaluation will be documented.

A mock exercise and tabletop exercise must be documented with the following information:

- The date of the exercise.
- A list of participants, including who led the exercise,
- A description of the emergency situation including conditions (weather, shutdown, etc.),
- Any drawings and documents (or reference to them) necessary to understand the exercise,
- A step-by-step description of actions “taken”,
- A debriefing of what went well and what went poorly or needs improvement, and
- A list of any corrective actions identified with dates and persons’ names assigned.

Hardcopies of this document are uncontrolled and may be assumed current only at the time of printing.

If a mock exercise involves the production of potentially:

- visible smoke or artificial smoke,
- audible (offsite) noise,
- additional traffic or vehicles that may attract attention/concern, or
- some other activity that may raise concern by persons nearby,

then Manitoba Conservation and local Fire Department(s) must be notified in advance. It is the responsibility of the facility holding the exercise to obtain any special permits (e.g.: Fire Permit), prior to the exercise, as required by local bylaws.

5.7. Emergency Plan Availability

All supervisory staff shall be given an electronic copy of this emergency plan. A hardcopy shall be kept at the main entrance door (reception).

6.0 TRAINING

All employees who do work at the Winnipeg (Kenaston) site must review the Winnipeg (Kenaston) Emergency Response Plan and re-review it annually and when revised.

All visitors and contractors must complete review of pertinent requirements of the Emergency Plan unless they are supervised/escorted during the time they are on the site.

7.0 RECORDS RETENTION AND DESTRUCTION

This Procedure shall be maintained electronically in the location noted in the header on the first page under "Document Location(s)". At least one previous revision shall be retained and archived. Older revisions are to be erased and all hard copies destroyed by disposal in the garbage or shredding.

8.0 ASSOCIATED DOCUMENTS

- 8.1 GFL-EHS-COR-002-PR Incident Investigation and Reporting Procedure
- 8.2 GFL-EHS-COR-024-PR Working Alone Procedure
- 8.3 GFL-HRP-COR-008 PR Workplace Violence and Harassment Policy

9.0 REFERENCES

- 9.1 Manitoba Flood Information and Updates: <https://www.gov.mb.ca/mit/floodinfo/index.html>
- 9.2 Winnipeg Truck Routes map:
<http://www.winnipeg.ca/publicworks/PDF/Transportation/truckroutemap.pdf>
- 9.3 Manitoba Infrastructure & Transportation Road Information:
<https://www.gov.mb.ca/mit/roadinfo/index.html>
- 9.4 Sign-up for Winnipeg Emergency Notifications via email:
http://www.winnipeg.ca/wpgmail/subscribe_all.stm?elist=1#city
- 9.5 Environment Canada website at: <http://weather.gc.ca/warnings/> .

Hardcopies of this document are uncontrolled and may be assumed current only at the time of printing.

APPENDIX A – Winnipeg Properties of Materials Onsite and Site Layout

GFL Environmental Inc. West will not receive, transport or dispose of the following wastes: Explosives (TDG Class 1), Radioactive (TDG Class 7 and regulated under the Canadian Nuclear Safety Act), or biological or pathological wastes.

Upon request or when appropriate, the following information will be supplied to Emergency Responders:

Bulk Waste Storage

The amount of bulk liquid and solid materials stored at the Hazardous Waste Storage Facility at any time will not exceed:

- 1,350,000 liters for de-ashed oil,
- 120,000 liters for used glycol,
- 1,050,000 liters for waste oil,
- 480,000 liters for light fuel,
- 40,000 liters for cleaned water,
- 120,000 liters for wastewater,
- 24,000 liters of sludge, and
- 48,000 liters of stabilized sludge

Bulked wastes are monitored at the facility in order to verify that both incoming and outgoing streams meet the applicable provincial criteria for handling and/or end use.

TANK IDENTIFICATION	CONTENTS	MAXIMUM VOLUME	NOMINAL VOLUME
Tank #F1	De-ashed oil	630,000 liters	315,000 liters
Tank #F2	De-ashed oil	630,000 liters	315,000 liters
Tank #K1	Used Glycol	120,000 liters	60,000 liters
Tank #K2	Waste oil	120,000 liters	60,000 liters
Tank #K3	Waste oil	120,000 liters	60,000 liters
Tank #K4	Waste oil	120,000 liters	60,000 liters
Tank #K5	Waste oil	120,000 liters	60,000 liters
Tank #K6	Waste oil	120,000 liters	60,000 liters
Tank #K7	Waste oil	120,000 liters	60,000 liters
Tank #K8	Waste oil	120,000 liters	60,000 liters
Tank #K9	Light fuel	120,000 liters	60,000 liters
Tank #K10	Light fuel	120,000 liters	60,000 liters
Tank #K11	Light fuel	120,000 liters	60,000 liters
Tank #K12	Light fuel	120,000 liters	60,000 liters
Tank #P1	Waste oil	60,000 liters	30,000 liters
Tank #P2	Waste oil	60,000 liters	30,000 liters
Tank #P3	De-ashed oil	60,000 liters	30,000 liters
Tank #P4	Waste oil	60,000 liters	30,000 liters
Tank #P5	Waste oil	15,000 liters	7,500 liters
Tank #P6	Waste oil	15,000 liters	7,500 liters
Tank #P7	De-ashed oil	15,000 liters	7,500 liters
Tank #P8	De-ashed oil	15,000 liters	7,500 liters
Solvent Tank	Solvent	1000 liters	500 liters

Hardcopies of this document are uncontrolled and may be assumed current only at the time of printing.

TANK IDENTIFICATION	CONTENTS	MAXIMUM VOLUME	NOMINAL VOLUME
Sludge Tank	Sludge	24,000 liters	12,000 liters
Polishing Tank A	Cleaned water	10,000 liters	5000 liters
Polishing Tank B	Cleaned water	10,000 liters	5000 liters
Tank 1	Wastewater	10,000 liters	5000 liters
Tank 2	Wastewater	10,000 liters	5000 liters
Tank 3	Wastewater	10,000 liters	5000 liters
Tank 4	Wastewater	10,000 liters	5000 liters
Tank 5	Wastewater	20,000 liters	10,000 liters
Tank 6	Wastewater	20,000 liters	10,000 liters
Tank 7	Wastewater	20,000 liters	10,000 liters
Tank 8	Wastewater	20,000 liters	10,000 liters
Clean Water Tank	Treated water	20,000 liters	10,000 liters
Sludge Bin	Stabilized sludge (dry solids)	48,000 liters	24,000 liters

Other Waste Storage

The amount of non-bulk wastes stored at the Hazardous Waste Storage Facility will not normally exceed:

- 200 drums of oily water, antifreeze, waste grease, oily rags, gun wash, and spent sorbent, batteries and light tubes/bulbs.
- 250 drums of waste solvent, and
- 350 drums of used oil filters.

Non-bulked wastes are monitored at the facility in order to verify that both incoming and outgoing streams meet the applicable provincial criteria for handling and/or end use.

LOCATION	WASTE TYPE AND PACKAGING	MAXIMUM VOLUME/AMOUNT	NOMINAL VOLUME/AMOUNT
Winnipeg Shop and Trailer Storage Area	Drums of used oil filters	350 drums	175 drums
Winnipeg Shop and Trailer Storage Area	Drums of oily water	25 drums	13 drums
Winnipeg Shop and Trailer Storage Area	Drums of used antifreeze	75 drums	37 drums
Winnipeg Shop and Trailer Storage Area	Drums of waste grease	8 drums	4 drums
Winnipeg Shop and Trailer Storage Area	Drums of oily rags	75 drums	37 drums
Winnipeg Shop and Trailer Storage Area	Drums of gunwash	10 drums	5 drums
Winnipeg Shop and Trailer Storage Area	Drums of lead-acid batteries	5 drums	3 drums
Winnipeg Shop and Trailer Storage Area	Drums of mercury-containing bulbs/tubes	2 drum	1 drum

Hardcopies of this document are uncontrolled and may be assumed current only at the time of printing.

LOCATION	WASTE TYPE AND PACKAGING	MAXIMUM VOLUME/AMOUNT	NOMINAL VOLUME/AMOUNT
Winnipeg Shop and Trailer Storage Area	Drums of Class 3 (waste solvent)	250 drums	125 drums
Outside the Winnipeg Shop on east concrete pad	Empty metal drums with oil residue	350 drums	175 drums
1 inside Winnipeg Shop 1 outside Winnipeg Shop	Scrap metal in bins	2 x 3.65 m ³ (12 yd ³) bins = 7.3 m ³ (24 yd ³)	3.65 m ³ (12 yd ³)

Properties of Used Oil, De-ashed Used Oil, In-process Used Oil and liquids from Used Oil Filters

- Somewhat viscous, dark brown liquid
- Insoluble in water
- Specific gravity = 0.876 to 0.905
- Flashpoint >60.5 °C - combustible
- Extinguishing media = water, foam, carbon dioxide or dry chemical (handle as a petroleum fire)
- Combustion products = carbon monoxide and carbon dioxide
- Non-reactive
- Can cause eye and skin irritation with direct contact
- Mists will cause respiratory tract irritation
- Ingestion causes gastrointestinal irritation
- Not TDG controlled
- Manitoba reportable spill quantity is 5 L.
- Safety glasses and skin protection required, when handling
- Keep out of sewers and watercourses

No NFPA diamond

Properties of Light Fuel

- Somewhat viscous, light brown liquid
- Insoluble in water
- Specific gravity = 0.876 to 0.905
- Flashpoint <60.5 °C - flammable
- Extinguishing media = water, foam, carbon dioxide or dry chemical (handle as a petroleum fire)
- Combustion products = carbon monoxide and carbon dioxide
- Non-reactive
- Can cause eye and skin irritation with direct contact
- Mists will cause respiratory tract irritation
- Ingestion causes gastrointestinal irritation
- TDG controlled – Class 3
- Manitoba reportable spill quantity is 5 liters
- Safety glasses and skin protection required, when handling
- Keep out of sewers and watercourses

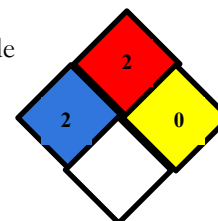

Hardcopies of this document are uncontrolled and may be assumed current only at the time of printing.

Properties of Glycol and Waste Antifreeze

- Somewhat viscous, clear & colourless liquid
- Soluble in water
- Specific gravity = 1.0 to 1.11
- Flashpoint 99 to 111°C
- Extinguishing media = water, foam, carbon dioxide or dry chemical
- Combustion products = carbon monoxide and carbon dioxide
- Avoid contact with strong acids & bases, oxidizers and heat
- Can cause eye and skin irritation with direct contact
- Can cause respiratory tract irritation
- Ingestion can cause kidney failure, vision impairment, and neurological problems
- TDG controlled – Class 3
- Manitoba reportable spill quantity is 5 liters
- Safety glasses and skin protection required, when handling
- Keep out of sewers and watercourses

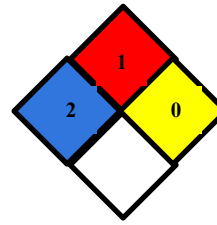

Properties of Sludge and Stabilized Sludge

- Thick, dark, grainy material
- Insoluble in water
- Specific gravity = approx. 1.5
- Flashpoint N/A
- Extinguishing media = Water, foam, carbon dioxide or dry chemical.
- Combustion products = carbon monoxide and carbon dioxide (from residual oil)
- Can cause eye and skin irritation with direct contact.
- Can cause mild irritation if inhaled
- Ingestion is unlikely
- Not TDG controlled
- Manitoba reportable spill quantity is 5 liters
- Safety glasses and skin protection required, when handling
- Keep out of sewers and watercourses

No NFPA diamond

Properties of Oily Water

Oily water has the same properties as water, except that there is a residue of oil in it (see Properties of Used Oil and liquids from Used Oil Filters)

No NFPA diamond

Properties of Waste Grease

- Colourless to slightly coloured grease
- Insoluble in water
- Specific gravity = 0.8 to 0.9
- Flashpoint 264°C
- Extinguishing media = water, foam, carbon dioxide or dry chemical
- Combustion products = carbon monoxide and carbon dioxide

No NFPA diamond

Hardcopies of this document are uncontrolled and may be assumed current only at the time of printing.

- Avoid contact with strong oxidizers
- Can cause eye irritation with direct contact
- Ingestion and skin contact has little to no effects
- Not TDG controlled
- Manitoba reportable spill quantity is 5 liters
- Safety glasses and skin protection should be used when handling
- Keep out of sewers and watercourses

Properties of Oily Rags

- Cloth stained with oil and having a petroleum odour
- Insoluble in water
- Combustible
- Extinguishing media = water, foam, carbon dioxide or dry chemical
- Combustion products = carbon monoxide and carbon dioxide
- Avoid contact with strong oxidizers
- Can cause eye irritation if oil on rags is directly contact
- Skin contact has little to no effects
- Not TDG controlled
- Manitoba reportable spill quantity is 5 liters
- Safety glasses and skin protection should be used when handling

No NFPA diamond

Properties of Gunwash and Waste Solvent

- Clear to amber liquid with a petroleum-like or aromatic odour
- Slightly to moderately soluble in water
- Combustible
- Extinguishing media = water, foam, carbon dioxide or dry chemical
- Combustion products = carbon monoxide and carbon dioxide
- Avoid contact with strong oxidizers
- Can cause eye and skin irritation (some solvents are absorbed through the skin)
- Most solvents and gunwash give off vapours that can cause respiratory irritation or even cause lightheadedness and nausea
- TDG controlled as Class 3 flammable liquids
- Manitoba reportable spill quantity is 100 liters
- Safety glasses and skin protection should be used when handling

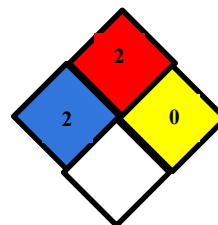

Properties of liquids in Lead-Acid Batteries (Class 8 sulphuric acid)

- Somewhat viscous, clear & lightly coloured liquid
- Soluble in water
- Specific gravity = 1.84
- Flashpoint = non-flammable
- If a fire is nearby, avoid using water; use dry chemical or CO₂ extinguisher
- Avoid contact with water, strong bases, combustibles, heat, oxidizers and organic materials

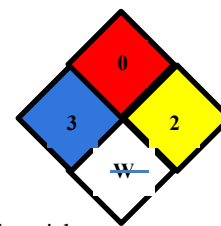

Hardcopies of this document are uncontrolled and may be assumed current only at the time of printing.

- Can cause severe eye and skin damage with direct contact
- Can cause severe respiratory tract irritation and damage if mists are inhaled
- Ingestion can cause severe damage to esophagus, stomach and intestinal tract as well as to internal organs.
- TDG controlled – Class 8
- Manitoba reportable spill quantity is 5 liters or 5 kg
- Safety goggles and full skin protection required, when handling
- Keep out of sewers and watercourses

Properties of Drums of Mercury-containing bulbs and tubes (based on presence of mercury vapour)

NOTE: The risk of over-exposure to mercury is remote given the very low quantity of mercury in bulbs and tubes.

- Colourless vapour
- Insoluble in water
- Specific gravity = 13.6 (for mercury)
- Flashpoint = non-flammable.
- Avoid breaking bulbs and tubes as this will release mercury vapour.
- Broken glass can cause cuts. The small amount of mercury in a single bulb or tube should not have any ill effects of a person. If a bulb or tube is broken indoors, leave the area for 30 minutes to allow it to ventilate.
- Not TDG controlled
- No Manitoba reportable spill quantity.
- Safety glasses and skin protection should be used when handling in case of breakage

No NFPA diamond

Kenaston Blvd.

Fence line

Asphalt Parking Lot

Heavy Truck Parking
And Trailer Storage

U/G Septic Tank

Office

North Gate

Main Tankfarm

Process Tankfarm

Pumphouse

Winnipeg Shop

Concrete Pad

Trash Bin

Solvent Tank

Scrap Metal Bin

Sea Cans

Sludge Bin

Sea Cans

Wastewater Treatment
Building

Loading Pad

Fence line

Fence line

Lowson Crescent

Fence line

**Winnipeg (Kenaston) Site
Layout**

-  Main Electrical Breaker
-  Main Gas Shutoff
-  Muster Points
-  Fire Hydrant & Valve
-  Audible alarms

Overview of Winnipeg (Kenaston) Site Layout
 (See details in Main Tank Farm, Process Tank Farm, Winnipeg Shop and Office Layouts – not all details are shown here)

Hardcopies of this document are uncontrolled and may be assumed current only at the time of printing.

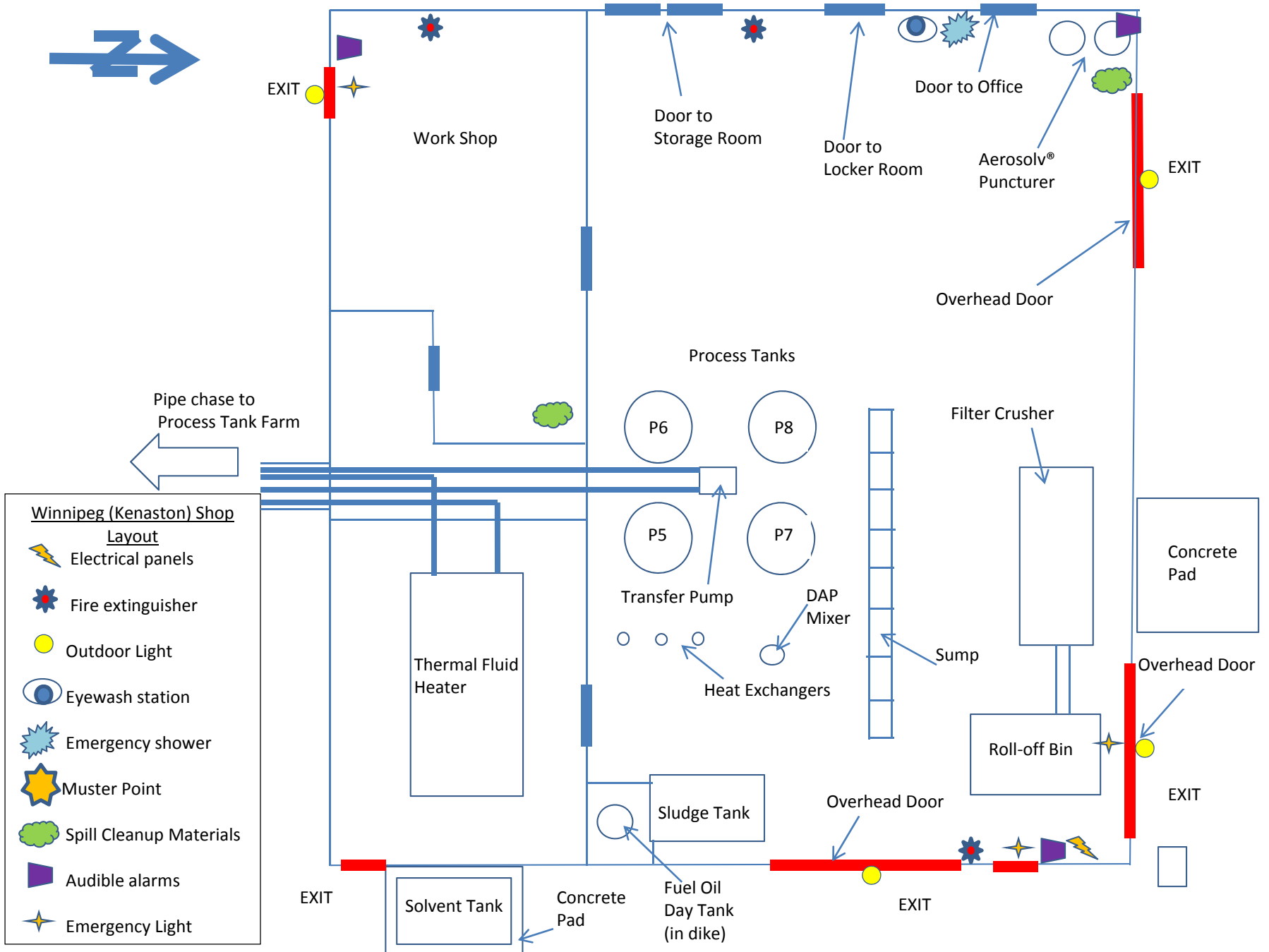

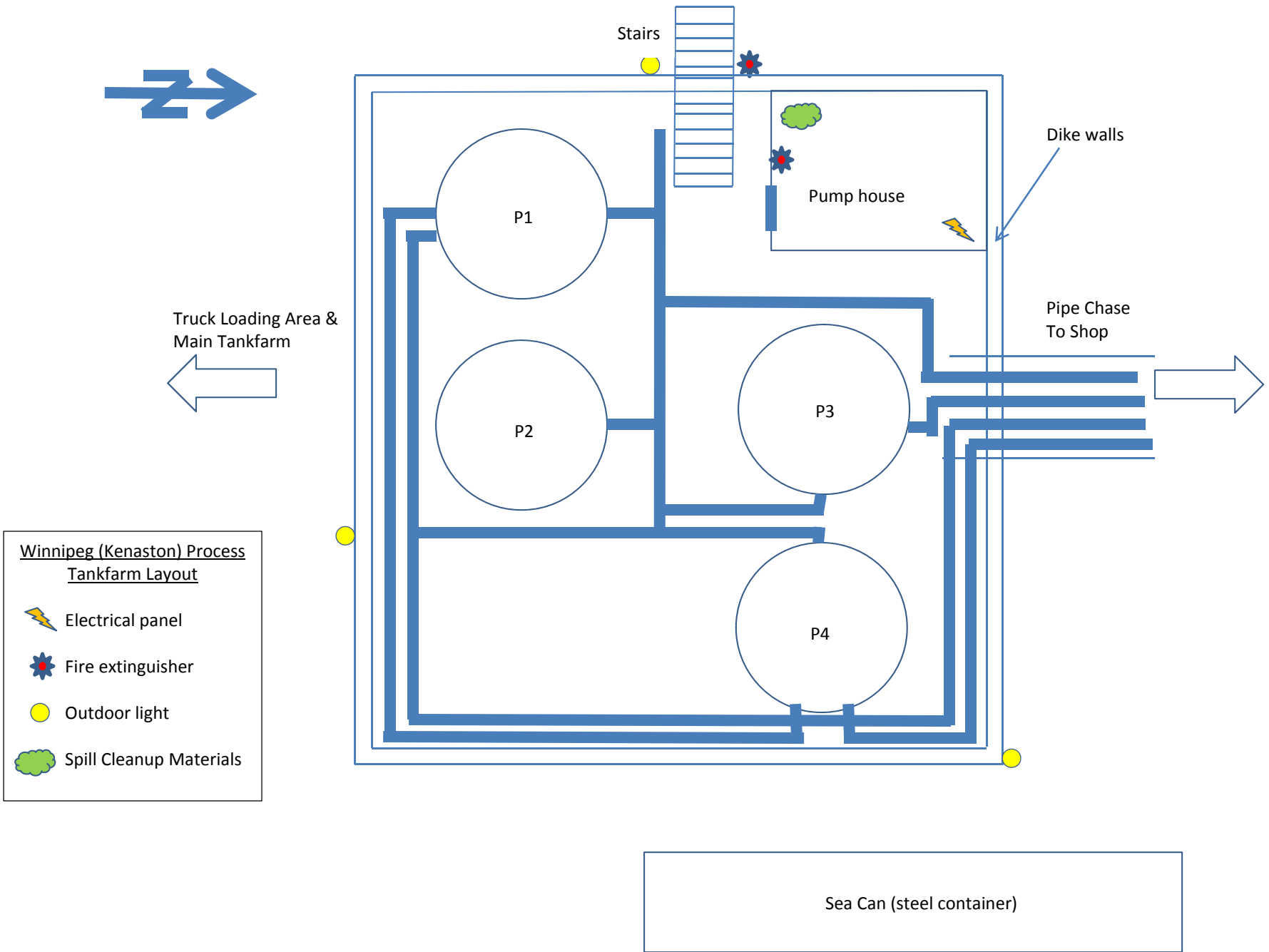

Hardcopies of this document are uncontrolled and may be assumed current only at the time of printing.



Hardcopies of this document are uncontrolled and may be assumed current only at the time of printing.

Winnipeg (Kenaston) Main Tankfarm

-  Fire extinguisher
-  Light standard
-  Spill Cleanup Materials

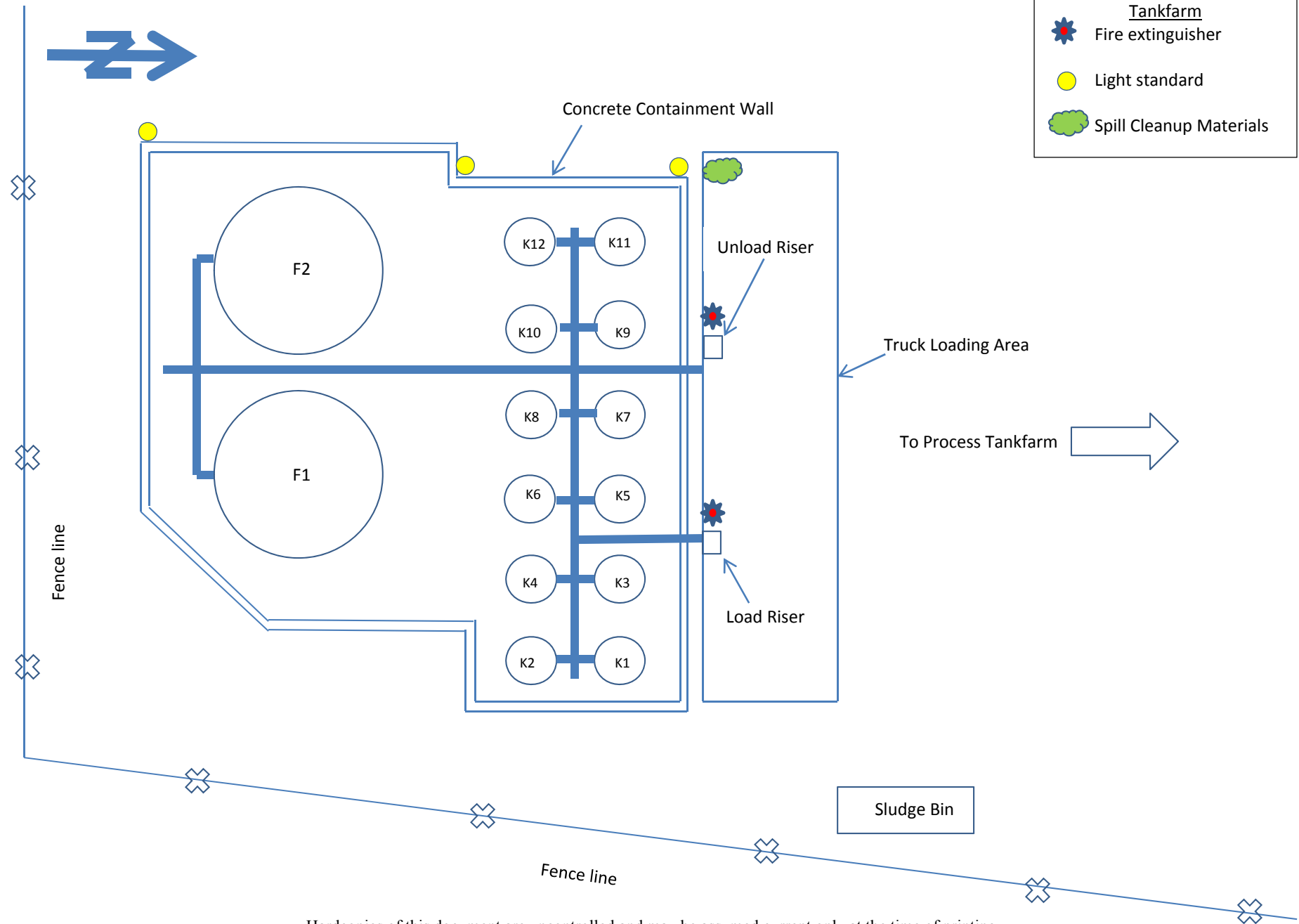

Hardcopies of this document are uncontrolled and may be assumed current only at the time of printing.



Winnipeg (Kenaston) Office Building

- Electrical panel
- Fire extinguisher
- First Aid Kit
- Spill Cleanup Materials
- Audible alarms
- Emergency Lighting

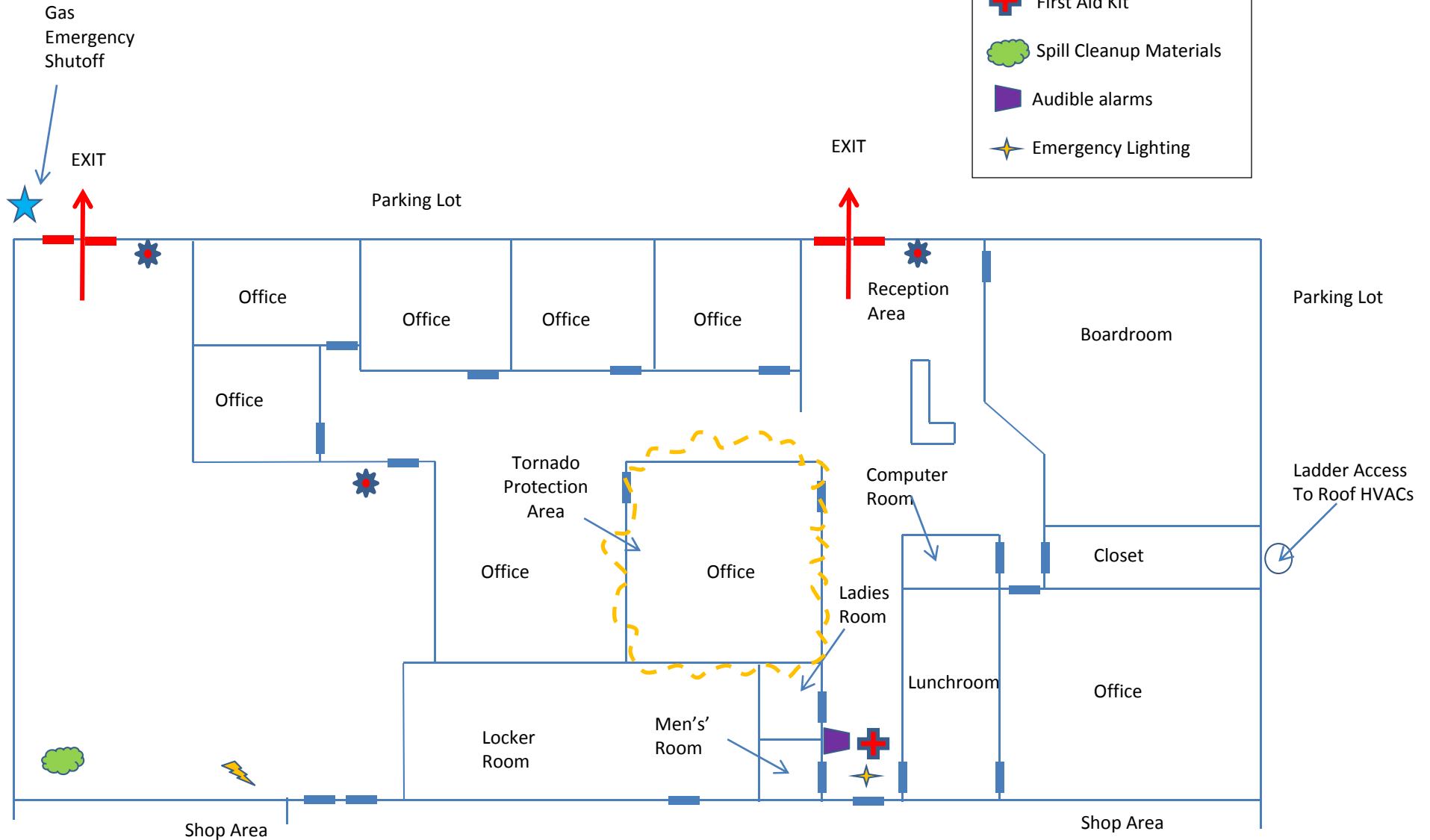

Hardcopies of this document are uncontrolled and may be assumed current only at the time of printing.

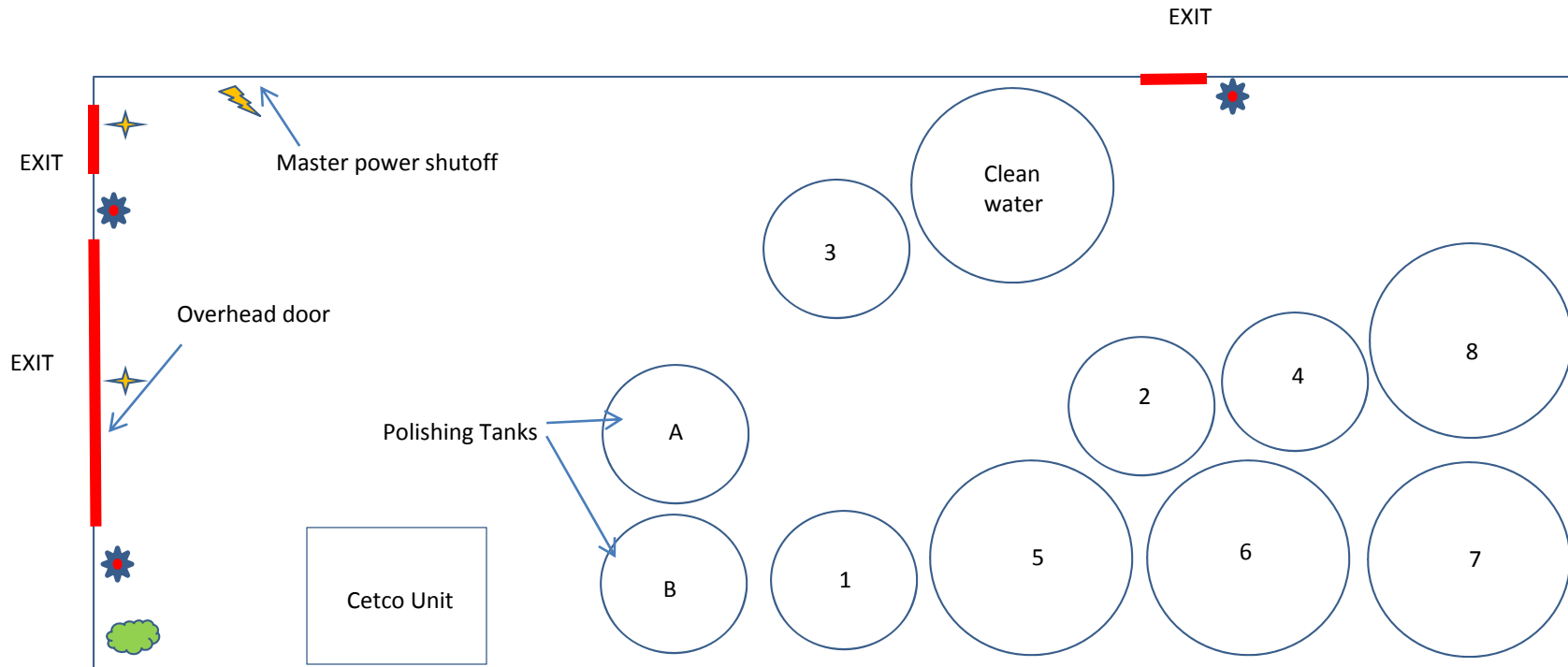

- Winnipeg (Kenaston) Wastewater Treatment Building
-  Electrical panel
 -  Fire extinguisher
 -  Spill Cleanup Materials
 -  Emergency Lighting

NOTE: Tanks 1 through 8 are dirty water tanks



APPENDIX B: Summary of Important Phone Numbers

GFL Contacts

Toll Free:	1-888-504-7100 (24 hr.)
Norm Klippenstein, Manitoba Operations Manager	cell: 204-781-2600
Jason Henkel, Winnipeg Operations Manager	cell: 204-999-0224
Andrew Gingrich, Exec. Dir. of Waste Services	cell: 403-507-5919
Jeremy Fossum, Exec. Dir. of Oil Collections & Burner Fuel	cell: 780-717-2257
John Powell, General Manager	cell: 780-887-8445
Nola Ruhl, Compliance Manager	cell: 780-984-1404

Regulators

Manitoba Workplace Health and Safety	1-866-415-8690
Manitoba Conservation	1-800-222-6514 (24 hours)
Manitoba Infrastructure & Transportation (road conditions)	511

Public Emergency Services

All emergency services	911
------------------------	-----

Other Resources

Manitoba Hydro (24/7)	(204) 480-5900 (in Winnipeg) (888) 624-9376 (outside Winnipeg)
Quantum Murray (emergency response & remediation)	1-877-378-7745
Clean Harbors (vacuum trucks)	204-231-9448
Inland Aggregates (gravel)	204-334-4300
Miller Environmental Corp. (waste disposal)	204-925-9600
Bison Fire Protection	204-237-3473

Appendix I: GFL Liquid Waste West and Winnipeg Site Tables of Contents
For Policies, Procedures, Forms and Work Instructions



Table of Contents EHS-COR Policies

Site: Corporate – Liquid West	Document ID: GFL-EHS-COR-000-PO	
Author: Compliance Manager	Category: Policies	
Approver: General Manager	Approval Date: January 22, 2014	Rev. No.: 0
Document Location (Edmonton office): Public(P:)/Compliance/Safety, Policy, Procedure/Policy Docs –pdf FINALS/Policy FINALS		

Table of Contents – EHS-COR Policies

No	Doc ID	Description	Rev.	Date
1	GFL-EHS-COR-001	Contractor Management Policy	Revision 0	December 4, 2013
1	GFL-EHS-COR-002	Safety Policy	Revision 0	January 10, 2014
1	GFL-EHS-COR-003	Prevention of Occupational Illness and Injury Policy	Revision 0	January 9, 2014
1	GFL-EHS-COR-004	Environmental Sustainability Policy	Revision 0	January 9, 2014
1	GFL-EHS-COR-005	Scent Sensitivity Policy	Revision 0	January 10, 2014
1	GFL-EHS-COR-006	Health and Safety Management Policy	Revision 0	January 10, 2016
1	GFL-EHS-COR-007	Internal Audit and Inspection Policy – DRAFT	Revision 0	Not Complete
1	GFL-EHS-COR-008	<i>Not currently in use</i>	Revision 0	

Hardcopies of this document are uncontrolled and may be assumed current only at the time of printing.



Table of Contents EHS-COR Procedures

Site: Corporate – Liquid West	Document ID: GFL-EHS-COR-000-PR	
Author: Compliance Manager	Category: Policies	
Approver: General Manager	Approval Date: January 22, 2014	Rev. No.: 0
Document Location (Edmonton office): Public(P:)/Compliance/Safety, Policy, Procedure/Policy Docs –pdf FINALS/Policy FINALS		

Table of Contents – EHS-COR Procedures

No	Doc ID	Description	Rev.	Date
1	GFL-EHS-COR-001	Risk Ranking Procedure	Revision 0	January 14, 2014
1	GFL-EHS-COR-002	Incident Investigation and Reporting Procedure	Revision 2	December 15, 2015
1	GFL-EHS-COR-003	Claims Management and Workers' Compensation Procedure	Revision 1	February 24, 2016
1	GFL-EHS-COR-004	Confined Space Entry Procedure	Revision 0	January 10, 2014
1	GFL-EHS-COR-005	Hazard Assessment Procedure	Revision 0	January 14, 2014
1	GFL-EHS-COR-006	Personal Protective Equipment Procedure	Revision 1	April 28, 2016
1	GFL-EHS-COR-007	Gas Monitoring Procedure	Revision 0	January 14, 2014
1	GFL-EHS-COR-008	Lockout Tagout Procedure	Revision 1	January 15, 2014
1	GFL-EHS-COR-009	Emergency Response Procedure	Revision 0	January 16, 2014
1	GFL-EHS-COR-010	Noise Control and Hearing Conservation Procedure	Revision 0	January 16, 2014
1	GFL-EHS-COR-011	Respiratory Protection Procedure	Revision 0	January 14, 2014
1	GFL-EHS-COR-012	Fall Protection Procedure	Revision 0	January 17, 2014
1	GFL-EHS-COR-013	Linebreaking Procedure	Revision 0	January 20, 2014
1	GFL-EHS-COR-014	Hot Work Procedure	Revision 0	January 20, 2014
1	GFL-EHS-COR-015	Aspects and Impacts Analysis Procedure	Revision 0	Not complete
1	GFL-EHS-COR-016	Hand and Power Tools Procedure	Revision 0	January 23, 2014
1	GFL-EHS-COR-017	Electrical Safety Procedure	Revision 0	January 23, 2014
1	GFL-EHS-COR-018	Fire Prevention and Protection Procedure	Revision 0	January 23, 2014
1	GFL-EHS-COR-019	Powered Mobile Equipment Procedure	Revision 1	July 9, 2015 (R1)
1	GFL-EHS-COR-020	Bloodborne Pathogens Procedure	Revision 0	January 24, 2014
1	GFL-EHS-COR-021	Ergonomics Procedure	Revision 0	January 24, 2014

Hardcopies of this document are uncontrolled and may be assumed current only at the time of printing.

No	Doc ID	Description	Rev.	Date
1	GFL-EHS-COR-022	Wastewater Handling and Disposal Procedure	Revision 1	May 10, 2016
1	GFL-EHS-COR-023	Waste Management Practices and Procedure	Revision 1	May 10, 2016
1	GFL-EHS-COR-024	Working Alone Procedure	Revision 1	November 20, 2015
1	GFL-EHS-COR-025	Preventing Heat and Cold Stress Procedure	Revision 0	January 27, 2014
1	GFL-EHS-COR-026	Chemical Hazards Procedure	Revision 1	April 27, 2016
1	GFL-EHS-COR-027	Rigging, Hoists and Cranes	Revision 1	July 13, 2015 (R1)
1	GFL-EHS-COR-028	Job Observation Procedure	Revision 1	January 28, 2014
1	GFL-EHS-COR-029	Safety Meetings Procedure	Revision 0	January 31, 2014
1	GFL-EHS-COR-030	Safety and Environmental Training Procedure	Revision 0	February 3, 2014
1	GFL-EHS-COR-031	Safe Work Permit Procedure	Revision 0	March 6, 2014
1	GFL-EHS-COR-032	Excavation Procedure	Revision 0	March 6, 2014
1	GFL-EHS-COR-033	Construction and Demolition Procedure	Revision 0	March 6, 2014
1	GFL-EHS-COR-034	Handling External Complaints	Revision 0	April 8, 2014
1	GFL-EHS-COR-035	Housekeeping Procedure	Revision 0	June 24, 2014
1	GFL-EHS-COR-036	PCB Handling	Revision 0	March 14, 2014
1	GFL-EHS-COR-037	<i>Not currently in use</i>	Revision 0	
1	GFL-EHS-COR-038	First Aid Procedure	Revision 0	November 23, 2015
1	GFL-EHS-COR-039	Company Safety Rules	Revision 0	November 25, 2015
1	GFL-EHS-COR-040	Naturally Occurring Radioactive Materials (NORM) Hazards Procedure	Revision 0	June 11, 2014
1	GFL-EHS-COR-041	<i>Not currently in use</i>	Revision 0	
1	GFL-EHS-COR-042	Facility Inspection Procedure	Revision 0	November 4, 2014
1	GFL-EHS-COR-043	Transportation Emergency Response Procedure (not completed)	Revision 0	N/A
1	GFL-EHS-COR-044	Spill Prevention and Containment Procedure	Revision 0	June 3, 2015
1	GFL-EHS-COR-045	Benzene Code of Practice	Revision 0	June 19, 2015
1	GFL-EHS-COR-046	Hydrogen Sulphide Code of Practice	Revision 0	August 20, 2015
1	GFL-EHS-COR-047	Fatigue Management Procedure	Revision 0	August 20, 2015

Hardcopies of this document are uncontrolled and may be assumed current only at the time of printing.

No	Doc ID	Description	Rev.	Date
1	GFL-EHS-COR-048	Field Level Hazard Assessment Procedure	Revision 0	January 29, 2016
1	GFL-EHS-COR-049	<i>Not currently in use</i>	Revision 0	

Hardcopies of this document are uncontrolled and may be assumed current only at the time of printing.



Table of Contents EHS-COR Work Instructions

Site: Corporate	Document ID: GFL-EHS-COR-000-WI	
Author: Compliance Manager	Category: Policies	
Approver: General Manager	Approval Date: January 22, 2014	Rev. No.: 0
Document Location (Edmonton office): Public(P:)/Compliance/Safety, Policy, Procedure/Policy Docs –pdf FINALS/Policy FINALS		

Table of Contents – EHS-COR Work Instructions

No	Doc ID	Description	Rev.	Date
1	GFL-EHS-COR-001	<i>Not currently in use</i>	Revision 0	
1	GFL-EHS-COR-002	Incident Reporting	Revision 2	July 24, 2015
1	GFL-EHS-COR-003	Occupational Illness Awareness	Revision 0	June 23, 2014
1	GFL-EHS-COR-004	Confined Space Attendant Responsibilities	Revision 0	December 24, 2015
1	GFL-EHS-COR-005	<i>Not currently in use</i>	Revision 0	
1	GFL-EHS-COR-006	Personal Protective Equipment Selection, Use and Care	Revision 0	January 17, 2014
1	GFL-EHS-COR-007	<i>Not currently in use</i>	Revision 0	
1	GFL-EHS-COR-008	<i>Not currently in use</i>	Revision 0	
1	GFL-EHS-COR-009	<i>Not currently in use</i>	Revision 0	
1	GFL-EHS-COR-010	Noise Exposure and Control	Revision 0	January 17, 2014
1	GFL-EHS-COR-011	Respiratory Protection Selection, Use and Care	Revision 0	January 17, 2014
2		Determining Respiratory Protection Requirements	Revision 0	April 1, 2014
1	GFL-EHS-COR-012	Accessing the top of Tank Trucks	Revision 0	January 20, 2014
2		Ladder Inspection and Use	Revision 0	January 20, 2014
1	GFL-EHS-COR-013	<i>Not currently in use</i>	Revision 0	
1	GFL-EHS-COR-014	Fire Watch Training	Revision 0	June 16, 2014
1	GFL-EHS-COR-015	<i>Not currently in use</i>	Revision 0	
1	GFL-EHS-COR-016	<i>Not currently in use</i>	Revision 0	
1	GFL-EHS-COR-017	Electrical Safety	Revision 0	January 23, 2014
1	GFL-EHS-COR-018	Fire Prevention and Protection	Revision 0	January 23, 2014
1	GFL-EHS-COR-019	<i>Not currently in use</i>	Revision 0	

Hardcopies of this document are uncontrolled and may be assumed current only at the time of printing.

No	Doc ID	Description	Rev.	Date
1	GFL-EHS-COR-020	Bloodborne Pathogens Awareness and Response	Revision 0	January 24, 2014
1	GFL-EHS-COR-021	Preventing Motion Injuries and Fatigue	Revision 0	January 24, 2014
1	GFL-EHS-COR-022	<i>Not currently in use</i>	Revision 0	
1	GFL-EHS-COR-023	<i>Not currently in use</i>	Revision 0	
1	GFL-EHS-COR-024	<i>Not currently in use</i>	Revision 0	
1	GFL-EHS-COR-025	Heat and Cold Stress Awareness	Revision 0	January 27, 2014
1	GFL-EHS-COR-026	Chemical Hazards Awareness	Revision 0	January 28, 2014
1	GFL-EHS-COR-027	<i>Not currently in use</i>	Revision 0	
1	GFL-EHS-COR-028	Performing Job Observations	Revision 0	November 24, 2014
1	GFL-EHS-COR-029	<i>Not currently in use</i>	Revision 0	
1	GFL-EHS-COR-030	<i>Not currently in use</i>	Revision 0	
1	GFL-EHS-COR-031	<i>Not currently in use</i>	Revision 0	
1	GFL-EHS-COR-032	<i>Not currently in use</i>	Revision 0	
1	GFL-EHS-COR-033	<i>Not currently in use</i>	Revision 0	
1	GFL-EHS-COR-034	<i>Not currently in use</i>	Revision 0	
1	GFL-EHS-COR-035	<i>Not currently in use</i>	Revision 0	
1	GFL-EHS-COR-036	PCB Handling	Revision 0	March 14, 2014
1	GFL-EHS-COR-037	Preventing Hand Injuries	Revision 0	March 14, 2014
1	GFL-EHS-COR-038	<i>Not currently in use</i>	Revision 0	
1	GFL-EHS-COR-039	Supervising Workers	Revision 0	May 23, 2014
1	GFL-EHS-COR-040	Naturally Occurring Radioactive Materials (NORM) Awareness	Revision 0	June 12, 2014
1	GFL-EHS-COR-041	Activating the ERAP	Revision 0	September 12, 2014
1	GFL-EHS-COR-042	Performing Facility Inspections	Revision 1	May 28, 2015
1	GFL-EHS-COR-043	<i>Not currently in use</i>	Revision 0	
1	GFL-EHS-COR-044	<i>Not currently in use</i>	Revision 0	

Hardcopies of this document are uncontrolled and may be assumed current only at the time of printing.

No	Doc ID	Description	Rev.	Date
1	GFL-EHS-COR-045	<i>Not currently in use</i>	Revision 0	
1	GFL-EHS-COR-046	<i>Not currently in use</i>	Revision 0	
1	GFL-EHS-COR-047	Fatigue Management	Revision 0	August 21, 2015
1	GFL-EHS-COR-048	Field Level Hazard Assessment Work Instruction	Revision 0	January 29, 2016
1	GFL-EHS-COR-049	<i>Not currently in use</i>	Revision 0	

Hardcopies of this document are uncontrolled and may be assumed current only at the time of printing.



Table of Contents EHS-COR Forms

Site: Corporate	Document ID: GFL-EHS-COR-000-F
Author: Compliance Manager	Category: Forms
Approver: General Manager	Approval Date: January 22, 2014 Rev. No.: 0
Document Location (Edmonton office): Public(P:)/Compliance/Safety, Policy, Procedure/Policy Docs –pdf FINALS/Policy FINALS	

Table of Contents – EHS-COR Forms

No	Doc ID	Description	Rev.	Date
1	GFL-EHS-COR-001	Contractor Management Questionnaire Form	Revision 0	December 4, 2013
2		Contractor Orientation Checklist Form	Revision 0	December 4, 2013
3		Contractor Site Safety Rules and Responsibilities Form	Revision 0	December 4, 2013
1	GFL-EHS-COR-002	Incident Investigation Report Form	Revision 2	December 15, 2015
2		Incident Closure Form	Revision 1	December 15, 2015
1	GFL-EHS-COR-003	Physical Demands Analysis Form	Revision 0	January 10, 2014
1	GFL-EHS-COR-004	<i>Not currently in use</i>	Revision 0	
1	GFL-EHS-COR-005	Hazard Assessment Form	Revision 0	January 14, 2014
2		Hazard Assessment Training Form	Revision 0	January 21, 2014
1	GFL-EHS-COR-006	<i>Not currently in use</i>	Revision 0	
1	GFL-EHS-COR-007	<i>Not currently in use</i>	Revision 0	
1	GFL-EHS-COR-008	Lock Removal Form	Revision 0	January 15, 2014
2		Lockout Form	Revision 0	January 15, 2014
1	GFL-EHS-COR-009	Guide for Identifying Potential Emergencies Form	Revision 0	January 15, 2014
1	GFL-EHS-COR-010	<i>Not currently in use</i>	Revision 0	
1	GFL-EHS-COR-011	<i>Not currently in use</i>	Revision 0	
1	GFL-EHS-COR-012	Ladder Inspection Form	Revision 0	January 20, 2014
2		Fall Protection Pre-Use Inspection Form	Revision 0	January 20, 2014
1	GFL-EHS-COR-013	<i>Not currently in use</i>	Revision 0	
1	GFL-EHS-COR-014	<i>Not currently in use</i>	Revision 0	
1	GFL-EHS-COR-015	<i>Not currently in use</i>	Revision 0	
1	GFL-EHS-COR-016	Hand and Power Tool Inspection Form	Revision 0	January 23, 2014
1	GFL-EHS-COR-017	<i>Not currently in use</i>	Revision 0	
1	GFL-EHS-COR-018	<i>Not currently in use</i>	Revision 0	



Table of Contents EHS-COR Forms

Site: Corporate	Document ID: GFL-EHS-COR-000-F
Author: Compliance Manager	Category: Forms
Approver: General Manager	Approval Date: January 22, 2014 Rev. No.: 0
Document Location (Edmonton office): Public(P:)/Compliance/Safety, Policy, Procedure/Policy Docs –pdf FINALS/Policy FINALS	

No	Doc ID	Description	Rev.	Date
1	GFL-EHS-COR-019	<i>Not currently in use</i>	Revision 0	
1	GFL-EHS-COR-020	<i>Not currently in use</i>	Revision 0	
1	GFL-EHS-COR-021	<i>Not currently in use</i>	Revision 0	
1	GFL-EHS-COR-022	<i>Not currently in use</i>	Revision 0	
1	GFL-EHS-COR-023	<i>Not currently in use</i>	Revision 0	
1	GFL-EHS-COR-024	<i>Not currently in use</i>	Revision 0	
1	GFL-EHS-COR-025	<i>Not currently in use</i>	Revision 0	
1	GFL-EHS-COR-026	<i>Not currently in use</i>	Revision 0	
1	GFL-EHS-COR-027	<i>Not currently in use</i>	Revision 0	
1	GFL-EHS-COR-028	Job Observation Form	Revision 0	January 28, 2014
1	GFL-EHS-COR-029	<i>Not currently in use</i>	Revision 0	
1	GFL-EHS-COR-030	BC Rights & Responsibilities	Revision 0	June 17, 2014
2		Alberta Rights & Responsibilities	Revision 1	June 17, 2014
3		Saskatchewan Rights & Responsibilities	Revision 1	June 17, 2014
4		Manitoba Rights & Responsibilities	Revision 1	June 17, 2014
5		Ontario Rights & Responsibilities	Revision 1.1	June 17, 2014
6		General Training Form	Revision 0	January 8, 2015
1	GFL-EHS-COR-031	Safe Work Permit Form	Revision 0	March 6, 2014
1	GFL-EHS-COR-032	<i>Not currently in use</i>	Revision 0	
1	GFL-EHS-COR-033	<i>Not currently in use</i>	Revision 0	
1	GFL-EHS-COR-034	External Complaints Form	Revision 0	April 8, 2014
1	GFL-EHS-COR-035	Housekeeping Inspection Form	Revision 0	June 24, 2014
1	GFL-EHS-COR-036	Safety Meeting Topic Sign Off Form	Revision 0	April 23, 2014
2		Toolbox Meeting Form	Revision 0	July 28, 2014
1	GFL-EHS-COR-037	Required PPE Form	Revision 0	June 4, 2014
1	GFL-EHS-COR-038	Transportation Emergency Response Record Form	Revision 0	May 15, 2014



Table of Contents EHS-COR Forms

Site: Corporate	Document ID: GFL-EHS-COR-000-F
Author: Compliance Manager	Category: Forms
Approver: General Manager	Approval Date: January 22, 2014 Rev. No.: 0
Document Location (Edmonton office): Public(P:)/Compliance/Safety, Policy, Procedure/Policy Docs –pdf FINALS/Policy FINALS	

No	Doc ID	Description	Rev.	Date
1	GFL-EHS-COR-039	<i>Not currently in use</i>	Revision 0	
1	GFL-EHS-COR-040	<i>Not currently in use</i>	Revision 0	
1	GFL-EHS-COR-041	<i>Not currently in use</i>	Revision 0	
1	GFL-EHS-COR-042	<i>Not currently in use</i>	Revision 0	
1	GFL-EHS-COR-043	<i>Not currently in use</i>	Revision 0	
1	GFL-EHS-COR-044	<i>Not currently in use</i>	Revision 0	
1	GFL-EHS-COR-045	<i>Not currently in use</i>	Revision 0	
1	GFL-EHS-COR-046	<i>Not currently in use</i>	Revision 0	
1	GFL-EHS-COR-047	<i>Not currently in use</i>	Revision 0	
1	GFL-EHS-COR-048	Field Level Hazard Assessment Form	Revision 0	January 29, 2016
1	GFL-EHS-COR-049	<i>Not currently in use</i>	Revision 0	



Table of Contents OPS-WIN Procedures

Site: Winnipeg (Kenaston)	Document ID: GFL-OPS-WIN-000-PR	
Author: Compliance Manager	Category: Procedures	
Approver: General Manager	Approval Date: June 26, 2014	Rev. No.: 0
Document Location (Edmonton office): Public(P:)/Compliance/Safety, Policy, Procedure/Policy Docs –pdf FINALS/Policy FINALS		

Table of Contents – OPS-WIN Procedures

No	Doc ID	Description	Rev.	Date
1	GFL-OPS-WIN-001	Winnipeg (Kenaston) Emergency Response Plan	Revision 2	June 1, 2016
1	GFL-OPS-WIN-002	<i>Currently not in use</i>	Revision 0	
1	GFL-OPS-WIN-003	<i>Currently not in use</i>	Revision 0	
1	GFL-OPS-WIN-004	<i>Currently not in use</i>	Revision 0	
1	GFL-OPS-WIN-005	<i>Currently not in use</i>	Revision 0	
1	GFL-OPS-WIN-006	<i>Currently not in use</i>	Revision 0	
1	GFL-OPS-WIN-007	<i>Currently not in use</i>	Revision 0	
1	GFL-OPS-WIN-008	<i>Currently not in use</i>	Revision 0	
1	GFL-OPS-WIN-009	<i>Currently not in use</i>	Revision 0	
1	GFL-OPS-WIN-010	<i>Currently not in use</i>	Revision 0	

Hardcopies of this document are uncontrolled and may be assumed current only at the time of printing.



Table of Contents OPS-WIN Work Instructions

Site: Winnipeg (Kenaston)	Document ID: GFL-OPS-WIN-000-WI
Author: Compliance Manager	Category: Work Instructions
Approver: General Manager	Approval Date: June 26, 2014 Rev. No.: 0
Document Location (Edmonton office): Public(P:)/Compliance/Safety, Policy, Procedure/Policy Docs –pdf FINALS/Policy FINALS	

Table of Contents – OPS-WIN Work Instructions

No	Doc ID	Description	Rev.	Date
1	GFL-OPS-WIN-001	Oberg Filter Crusher System Operation	Revision 0	June 24, 2014
1	GFL-OPS-WIN-002	Eko Filterpak 1500 Crusher System Operation	Revision 0	July 2, 2014
1	GFL-OPS-WIN-003	Winnipeg Tank Farm Operations	Revision 0	July 2, 2014
1	GFL-OPS-WIN-004	Water Analysis in Oil (Retort Machine)	Revision 0	July 3, 2014
1	GFL-OPS-WIN-005	Processing De-Ashed Oil	Revision 0	July 3, 2014
1	GFL-OPS-WIN-006	Cleaning Tanks P5 and P6 Heating Coils	Revision 0	July 3, 2014
1	GFL-OPS-WIN-007	Pressure Washer Operation	Revision 0	July 3, 2014
1	GFL-OPS-WIN-008	Puncturing Aerosol Cans	Revision 0	July 4, 2014
1	GFL-OPS-WIN-009	Collection of Drummed and Bagged Wastes	Revision 0	July 4, 2014
1	GFL-OPS-WIN-010	Processing Unidentified and Mislabeled Waste	Revision 0	July 4, 2014
1	GFL-OPS-WIN-011	Drum Movement Work Instructions	Revision 0	July 4, 2014
1	GFL-OPS-WIN-012	Truck Dispensing of Glycol & Washer Fluid	Revision 0	July 4, 2014
1	GFL-OPS-WIN-013	Dispensing of Glycol from a Tote in a Truck	Revision 0	July 7, 2014
1	GFL-OPS-WIN-014	Winnipeg Tank Farm Transfers	Revision 0	July 7, 2014
1	GFL-OPS-WIN-015	Making Washer Fluid	Revision 0	July 7, 2014
1	GFL-OPS-WIN-016	CUDA Drum Washer Operation	Revision 0	July 7, 2014
1	GFL-OPS-WIN-017	Tote Cleaning	Revision 0	July 7, 2014
1	GFL-OPS-WIN-018	Hydroscout Operation	Revision 0	July 8, 2014
1	GFL-OPS-WIN-019	Using Tire Chains	Revision 0	July 8, 2014
1	GFL-OPS-WIN-020	Filling the Hazco Bin	Revision 0	July 8, 2014

Hardcopies of this document are uncontrolled and may be assumed current only at the time of printing.

No	Doc ID	Description	Rev.	Date
1	GFL-OPS-WIN-021	Loss of Suction During Loading/Unloading	Revision 0	July 9, 2014
1	GFL-OPS-WIN-022	Used Oil Collection at Customer Sites	Revision 0	July 23, 2014
1	GFL-OPS-WIN-023	Truck Fueling, Greasing and Changing Oil	Revision 0	July 23, 2014
1	GFL-OPS-WIN-024	Coupling and Uncoupling Trucks and Trailers	Revision 0	July 23, 2014
1	GFL-OPS-WIN-025	Performing Closed Cup Flash Test	Revision 0	December 3, 2014
1	GFL-OPS-WIN-026	Oil Transfer at Customer Sites	Revision 0	May 19, 2015
1	GFL-OPS-WIN-027	Processing Water in Cetco Machine	Revision 0	October 21, 2015
1	GFL-OPS-WIN-028	Truck Transferring into Cetco Tanks for Treatment	Revision 0	April 18, 2016
1	GFL-OPS-WIN-029	Parts Washer Solvent Change Out	Revision 0	April 18, 2016
1	GFL-OPS-WIN-030	CUDA Drum Washer – Load/Unload onto a Truck	Revision 0	April 19, 2016

Hardcopies of this document are uncontrolled and may be assumed current only at the time of printing.



Table of Contents OPS-WIN Forms

Site: Winnipeg (Kenaston)	Document ID: GFL-OPS-WIN-000-F
Author: Compliance Manager	Category: Forms
Approver: General Manager	Approval Date: June 26, 2014 Rev. No.: 0
Document Location (Edmonton office): Public(P:)/Compliance/Safety, Policy, Procedure/Policy Docs –pdf FINALS/Policy FINALS	

Table of Contents – OPS-WIN Forms

No	Doc ID	Description	Rev.	Date
1	GFL-OPS-WIN-001	Winnipeg Facility Inspection Form	Revision 1	October 21, 2015
2		Fire Extinguisher Inspection Form	Revision 0	June 29, 2015
3		Cetco Daily inspection Form	Revision 0	October 21, 2015
1	GFL-OPS-WIN-002	<i>Currently not in use</i>	Revision 0	
1	GFL-OPS-WIN-003	Winnipeg Tankfarm Tracking Form	Revision 0	July 3, 2014
2		Winnipeg Daily Tankfarm Readings Form	Revision 0	July 3, 2014
1	GFL-OPS-WIN-004	<i>Currently not in use</i>	Revision 0	
1	GFL-OPS-WIN-005	<i>Currently not in use</i>	Revision 0	
1	GFL-OPS-WIN-006	<i>Currently not in use</i>	Revision 0	
1	GFL-OPS-WIN-007	<i>Currently not in use</i>	Revision 0	
1	GFL-OPS-WIN-008	<i>Currently not in use</i>	Revision 0	
1	GFL-OPS-WIN-009	<i>Currently not in use</i>	Revision 0	
1	GFL-OPS-WIN-010	Drum Inspection Report Form	Revision 0	July 4, 2014
1	GFL-OPS-WIN-011	<i>Currently not in use</i>	Revision 0	
1	GFL-OPS-WIN-012	<i>Currently not in use</i>	Revision 0	
1	GFL-OPS-WIN-013	<i>Currently not in use</i>	Revision 0	
1	GFL-OPS-WIN-014	<i>Currently not in use</i>	Revision 0	
1	GFL-OPS-WIN-015	<i>Currently not in use</i>	Revision 0	
1	GFL-OPS-WIN-016	<i>Currently not in use</i>	Revision 0	
1	GFL-OPS-WIN-017	<i>Currently not in use</i>	Revision 0	
1	GFL-OPS-WIN-018	<i>Currently not in use</i>	Revision 0	

Hardcopies of this document are uncontrolled and may be assumed current only at the time of printing.