

Edwards, G. A. and W. N. Howard. 1980

**Little Waterhen River
Fish Movement and
Walleye Tagging Study,
1971-1972.**

MANIT  BA
DEPARTMENT OF NATURAL RESOURCES

MS Report No. 80-8

Edwards, G. A. and W. N. Howard, 1980. Little Waterhen River fish movement and walleye tagging study, 1971-72. Manitoba Dept. of Natural Resources. MS Report No. 780-28, 53p.

ABSTRACT

Open water and winter trap netting techniques and resultant seasonal fish catches are described for the Little Waterhen River, 1971-1972. All walleyes, Stizostedion vitreum, were tagged and the tag recovery rates for adjoining areas of the Waterhen River, Waterhen Lake, Lake Manitoba and Lake Winnipegosis are provided.

The dominant species caught in the traps were suckers (Catostomus sp.), burbot (Lota lota), walleyes and northern pike (Esox lucius). Seasonal fish movements indicated a preponderance of downstream migration but these results could be biased by missed upstream runs, a limited walleye dispersal period and the possibility of a cyclical movement between the Western Waterhen River and the Little Waterhen River. Most fish movement was associated with spawning activity.

Of the 4,980 walleyes tagged, 1,808 (36%) were recovered between 1971 and 1976. No walleyes were recovered north of Red Deer Point on Lake Winnipegosis or south of the Lake Manitoba Narrows. No tagged walleyes were recovered below the Fairford Dam. One walleye was recovered 40 days after release about eighty miles from the tagging site. In contrast, 65% of the recaptured walleyes

were returned in 1971 before the project was complete and over 93% of these were caught close to the tagging site in Lake Waterhen and the Waterhen River system.

The Waterhen system produced 1,487 tag recoveries, Lake Manitoba 189, and Lake Winnipegosis 132.

Although more tagged walleyes were recovered over a longer period of time from Lake Manitoba relative to Lake Winnipegosis, the Waterhen River complex is a prime spawning area for Lake Manitoba walleyes and an even higher percentage of tag returns from Lake Manitoba might be expected. This observation plus results from other more recent tagging studies show that there is periodic upstream movement into Lake Waterhen and Lake Winnipegosis. Significant fish losses out of Lake Winnipegosis remain a distinct possibility but further tagging, especially in the Long Island Bay area, is required.

TABLE OF CONTENTS

	Page
ABSTRACT	i
LIST OF FIGURES	v
LIST OF TABLES	vi
INTRODUCTION	1
METHODS	3
A. General	3
B. Trap Netting-Open Water	7
a) Preparation	7
b) Setting the Trap Nets	9
Upstream Trap	9
Downstream Trap and Lead	9
c) Lifting the Traps	10
d) Resetting the Traps	11
e) Trap Netting Problems	11
f) Open Water Set of 1972	12
C. Trap Netting-Under the Ice	12
a) Preparation	12
b) Setting the Trap Nets	14
Upstream Trap	14
Downstream Trap	15
c) Installing the Leads	15
d) Lifting the Winter Traps	17
e) Trap Netting Problems	17

	Page
D. Handling the Fish	18
a) Walleye	18
b) Other Species	18
 RESULTS	
Walleye	19
Northern Pike	21
Sauger	21
Lake Whitefish	21
Cisco (Tullibee)	21
Yellow Perch	22
Goldeye	22
Suckers	22
Burbot	32
Other Species	32
Tagging Results	32
DISCUSSION	44
ACKNOWLEDGMENTS	52
LITERATURE CITED	53

LIST OF FIGURES

Figures	Page
1. Waterhen drainage and trap net site	2
2. Trap net design	4
3. Tightener and spreader arrangement	5
4. Trap net installation (summer operation)	6
5. Trap net installation (winter operation).	13
6. Walleye production	23
7. Northern pike production	24
8. Sauger production	25
9. Whitefish production	26
10. Cisco (tullibee)production	27
11. Yellow perch production	28
12. Goldeye production	29
13. Sucker production	30
14. Burbot production	31
15. Areas of walleye recaptures	34

LIST OF TABLES

Table	Page
1. Monthly walleye tagging from upstream and downstream traps, Little Waterhen River, 1971 and 1972	20
2. Walleye recaptures expressed as percent of number tagged for various locations and each month of tagging	35
3. Monthly walleye tag recaptures relative to known and unknown date of recapture	36
4. Numbers and percentages, in parentheses, of annual recaptures (with known recovery dates) in six tag recapture areas	37
5. Waterhen Lake tag recaptures from each month of tagging from June, 1971 to June, 1972. Recaptures recorded for each quarterly period in each year .	38
6. Waterhen rivers tag recaptures from each month of tagging from June, 1971 to June, 1972. Recaptures recorded for each quarterly period in each year .	39
7. Lake Manitoba West tag recaptures from each month of tagging from June, 1971 to June, 1972. Recaptures recorded for each quarterly period in each year .	40
8. Lake Manitoba East tag recaptures from each month of tagging from June 1971 to June, 1972. Recaptures recorded for each quarterly period in each year .	41
9. Long Island Bay tag recaptures from each month of tagging from June, 1971 to June 1972. Recaptures	

Table	Page
recorded for each quarterly period in each year . .	42
10. Lake Winnipegosis tag recaptures from June, 1971 to June, 1972. Recaptures recorded for each quarterly period in each year	43

INTRODUCTION

Fluctuating walleye, (Stizostedion vitreum), (Mitchill) stocks in Lake Winnipegosis and the contention by Lake Winnipegosis commercial fishermen that walleyes are migrating downstream from and out of Lake Winnipegosis led to a fish movement study. It was conducted over a period of about one year in 1971-72. The Little Waterhen River ($51^{\circ}57'$ Lat, $100^{\circ}20'$ Long), which flows from Lake Winnipegosis into Waterhen Lake, was chosen as the study location. The Little Waterhen River is one of two tributaries connecting Lake Winnipegosis with Waterhen Lake. The West Waterhen River is the other connecting tributary. The East Waterhen River flows from Waterhen Lake to Lake Manitoba to complete the water route from Lake Winnipegosis to Lake Manitoba (Figure 1). Therefore, fish movement between the two major water bodies is possible.

The mouth of the Little Waterhen River, near the settlement of Skownan, was believed to be a suitable study location (Figure 1). A location at the outlet of Lake Winnipegosis would have been preferred but this area was too shallow for trap nets and the channel near Long Island was too wide to block off. The width and depth of the channel at the mouth of the Little Waterhen made it feasible to completely block the channel by the use of trap nets. It was assumed that the walleye movements in the Little Waterhen River would be a representative sample of the entire movement in both tributaries.

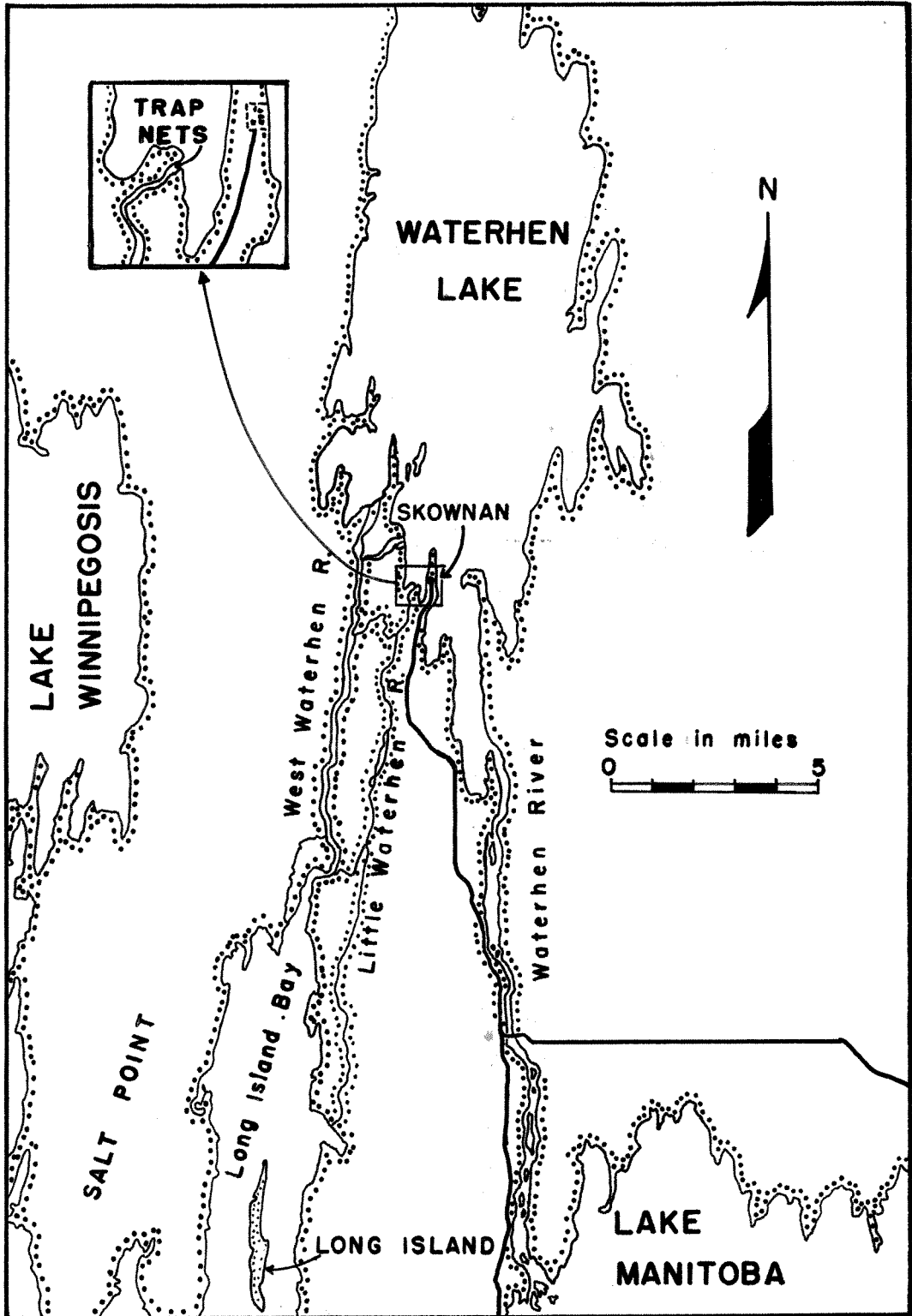

Figure 1. Waterhen drainage and trap net site.

METHODS

A. General

Tagging was conducted from June 2, 1971 to June 6, 1972. The trap nets were removed during freeze-up for the months of November and December, 1971 and were reset on January 18, 1972. The nets were removed during spring break up from April 11 to May 4, 1972. The nets were **usually** fished daily except when fish runs were light.

Two trap nets were used for the project. The traps were set facing one another in the river which served to trap fish which moved either upstream or downstream (Figure 4). The upstream trap captured fish moving upstream, while the downstream trap captured fish moving downstream.

The two trap nets were constructed of No. 15 treated nylon netting, 1 1/2 inch mesh stretched measure, framed on 11/32 inch polypropylene rope with double selvage. The dimensions of the traps are shown in Figure 2. Tunnel openings were 10 inches² and centered in the crib.

A 3 inch mesh stretched measure lead, 8 feet deep by 150 feet long connected the two traps. It was constructed of No. 15 Primolite treated nylon netting, double selvaged onto 11/32 polypropylene rope.

Miscellaneous equipment included metal can-type floats, one pound cast iron weights, 14 anchors rigged with 11/32 inch polypropylene rope and plastic seine net floats for marker buoys. A spreader and tightener were also used (Figure 3).

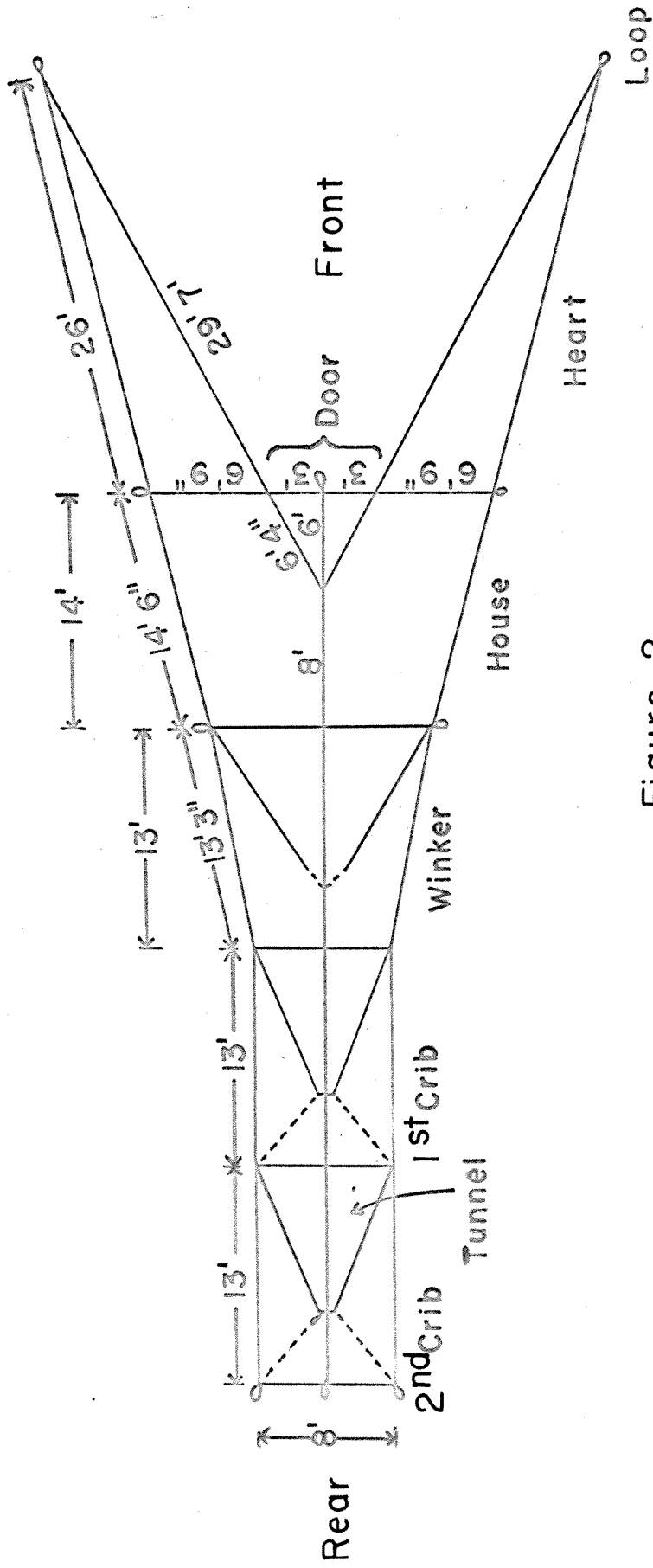

Figure 2.

TRAP NET DESIGN

TOP VIEW

6 ft. deep throughout

Not drawn to scale

— = basic rope frame

SPREADER (End view of trap)

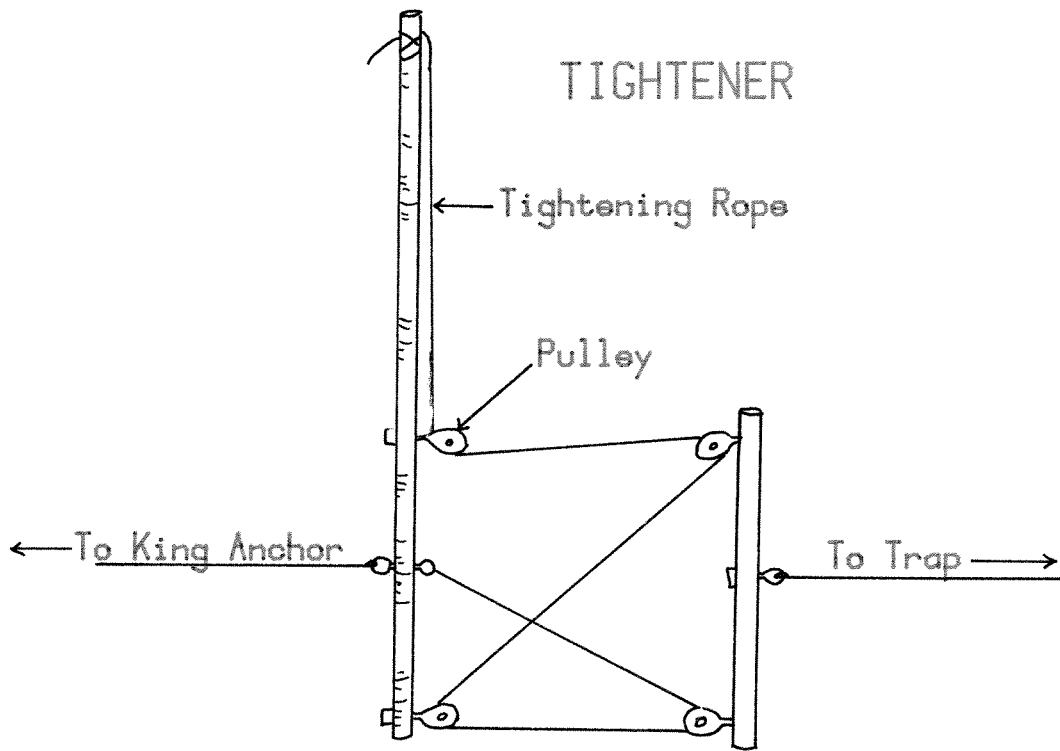
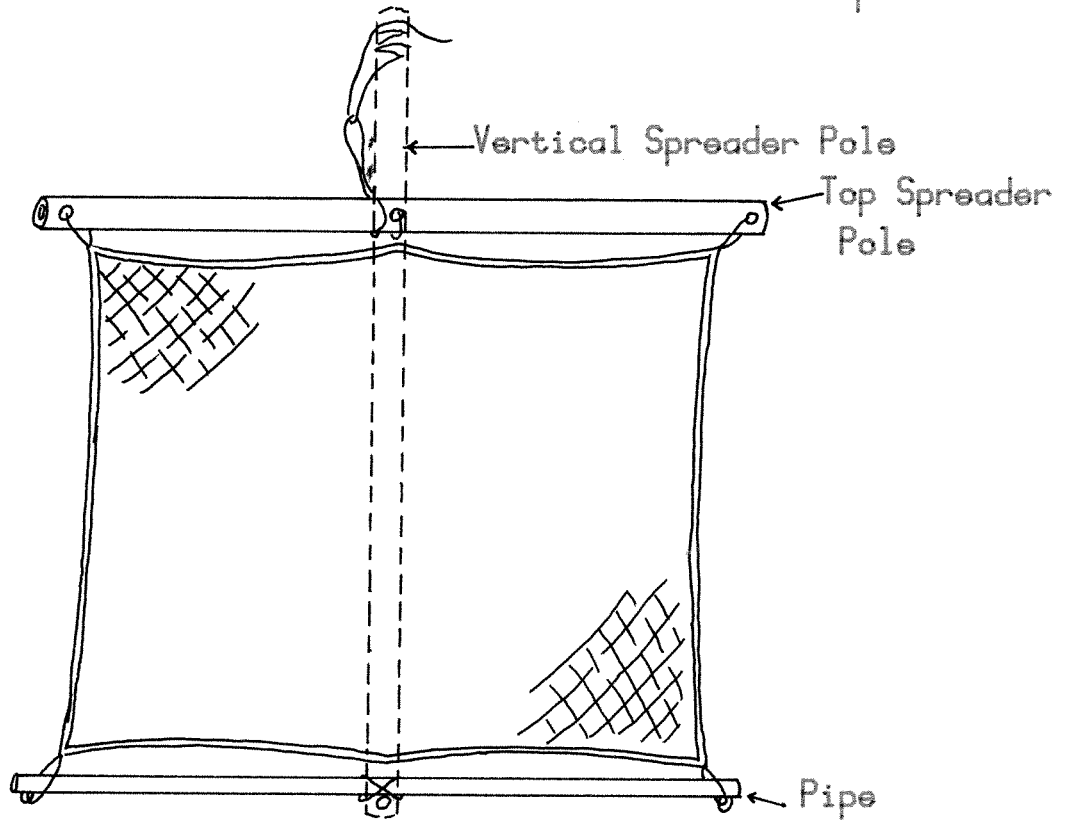

Figure 3. Tightener and Spreader Arrangement

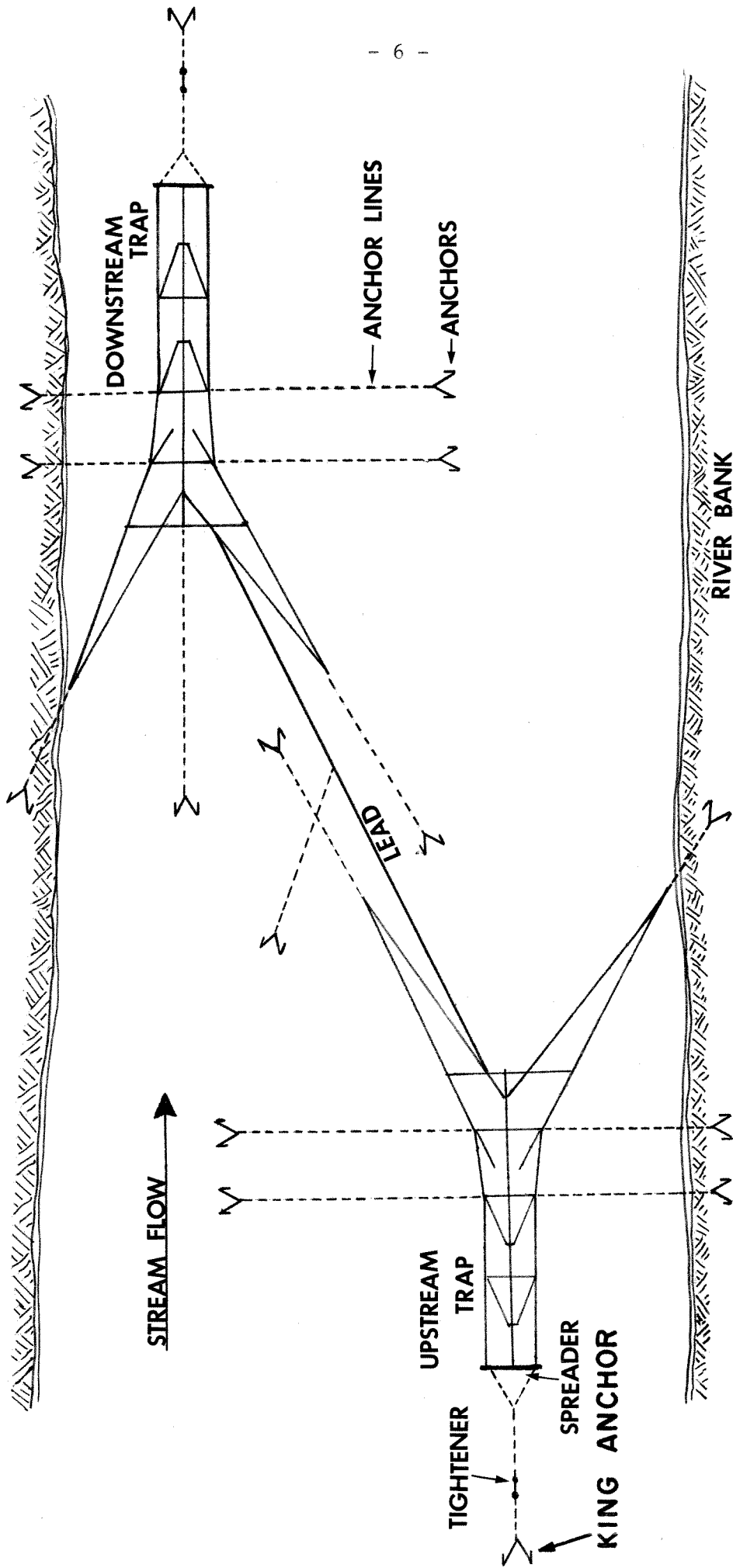

Figure 4. TRAP NET INSTALLATION
 (SUMMER OPERATION)
 WATERHEN RIVER FISH MOVEMENT STUDY
 1971 - 1972

Equipment varied in the winter operation (see section on trap netting under the ice). Pre-fabricated 12 feet by 12 feet plywood sheds were used for shelters to provide warmer working conditions and limit the amount of ice formation at the lifting holes.

For the open-water operation two boats were used to set the traps. These included an 18 foot wooden yawl with a 20 h.p. outboard. A 20 foot wooden yawl replaced the 18 foot yawl in the spring of 1972.

A pre-fabricated lockup shed was erected on the shore near the traps. This served as storage for fuel, oil, dip nets, extra rope and net repairing materials. A 12 foot travel trailer was used as a base camp for a summer student and a trap net fisherman.

The walleyes were tagged with Floy anchor tags inserted with a Floy tagging gun Model FD-67.

Tags were recovered by anglers and commercial fishermen during the respective open seasons. A reward of \$1.00 for each tag was offered for the return of these tags. Signs were posted at appropriate locations to inform people of the reward offered and where to return tags.

Fish nomenclature is that of Bailey (1970).

B. Trap Netting-Open Water

(a) Preparation

Before setting, the nets were rigged with floats, cast iron weights and bridles. The floats were tied on all top lines at eight foot intervals. The weights were tied at four foot intervals to all

the bottom lines. Double weights were used at both ends of the house, winker and cribs. Bridles were tied on each side of the trap at the front of the house and winker (Figure 2). Lifting lines were tied to the bottom lines at the front of each crib, threaded through loops on the top lines and joined at the top of the trap. A plastic marker buoy and down-line was tied to each lifting line.

A spreader arrangement was used on the end of each trap to keep the net spread vertically and horizontally (Figure 3). The vertical spreader pole was permanently tied to the bottom pipe and temporarily tied to the top spreader pole with half-hitches. This arrangement allowed the fishermen to collapse the end of the trap before the lifting operation.

A tightener was also constructed for each trap which consisted of an 8 foot and a 3 foot pole, four pulleys and a tightening rope (Figures 3 and 4). The tightener enabled the fishermen to tighten the trap net even under the force of the current.

Sixteen anchors were used to anchor the two traps. Each of ten anchors required 120 feet of rope and six required 90 feet of rope each.

A 300 foot lead was cut in half, with one 150 foot section to be used as a spare. Floats were tied on at 8 foot intervals along the top line and cast iron weights tied on at 4 foot intervals along the bottom line. One end of the lead was seamed to the mid-stream

side of the upstream trap (Figure 4).

(b) Setting the Trap Nets

The two trap nets, lead, spreaders and tighteners were loaded into the yawl boat. The anchors and lines were loaded into a 15 foot tri-hull and taken to the fishing site.

Upstream Trap- The king anchor for the upstream trap (Figure 4) was set about a hundred feet upstream of the selected fishing site. The anchor line was tied to the tightener, and the tightener to the trap. The trap net was fed out of the yawl as far as the winker at which point two anchors were tied on (one on each side). The anchors were then set on the river bank and in midstream. Two anchors were similarly tied at the front of the house and set. These four anchors were tightened before feeding out the rest of the trap and part of the lead. The shore wing was anchored tight to the shore with the anchor embedded in the riverbank. The mid-stream wing was then set and tightened. The spreader was then tightened to complete the set.

Downstream Trap and Lead-The lead (which was seamed to the upstream trap) was transferred to the tri-hull. The yawl boat took one of the anchors and proceeded to the opposite shore about twenty yards downstream. This anchor was embedded in the riverbank and tied to the shore wing of the downstream trap. The tri-hull set the remainder of the lead until it met the yawl boat. The end of the lead was seamed to the midstream side of the downstream trap net. The trap net was fed out of the yawl until the front of the house was reached.

The remaining side anchors were tied on and set by the tri-hull and finally the remainder of the trap was let out and the king anchor set. Some adjustments of the anchor lines completed the set.

An additional anchor was later installed on and set by the tri-hull and finally the remainder of the trap was let out and the king anchor set. Some adjustments of the anchor lines completed the set.

An additional anchor was later installed on the upstream side of the lead to prevent the lead from bagging in the current.

(c) Lifting the Traps

The following procedure was used for lifting the traps:

- 1) The buoy line to the tightener was picked up and the tension on the trap released (Figure 3).
- 2) The tension on the spreader was released by untying the vertical pole from the top spreader pole (Figure 3).
- 3) The marker buoy attached to the lifting lines of the first crib was picked up and the net lifted over the bow of the boat. The net was pulled back towards the centre of the boat. Before this operation could be accomplished, a stabilizing line had to be tied to an upstream section of the trap and to the stern of the boat. This kept the boat crossways in the current and perpendicular to the side of the trap. By working the trap net over the gunwales the trapped fish were forced into the end crib.
- 4) Two four foot winch-poles were attached to the gunwales, eight feet apart, on one side of the boat. A rope and pulley system at the top end of each pole allowed the fishermen to lift the end of

the trap by winching the top spreader pole and net about four feet clear of the water.

- 5) The "zipper" (an opening in the top of the trap on the last crib, held closed with seaming twine) was opened and fish were dip-netted from the crib.

(d) Resetting the Traps

- 1) Once the fish were removed, the zipper was seamed closed and the winch-pole lines were released to return the net and top spreader pole to the water.
- 2) The boat was worked back to the front of the first crib and the net was lifted over the bow of the boat and returned to the water.
- 3) The spreader was then adjusted to spread the trap end and secure it to the vertical spreader pole.
- 4) The trap was stretched tight with the tightener.

(e) Trap Netting Problems

The leads collected debris creating excessive force on the anchors. The leads, therefore, required frequent cleaning. Some of this debris also rolled up in the downstream trap and plugged the funnels, blocking access for the fish. This problem was partially eliminated by letting the lead bag a short distance ahead of the door. The majority of the weeds were caught in this fashion before they could enter the trap.

Later, two extra anchors were installed to support the door and the shore wing of the downstream trap. Longer anchor ropes were installed on each king anchor and the hooks of these anchors adjusted to provide additional anchoring strength.

High summer water levels necessitated the addition of a two foot false lead to the existing lead and wings of the traps. These false leads were made of six inch mesh material.

(f) Open Water Set of 1972

Some slight changes were made in 1972 to the type of set described for 1971. Instead of seaming the lead to the doors of both traps, they were seamed directly to the ends of the trap net wings. Because of this, no anchor was required for the mid-stream wing of the upstream trap. A short lead was added to the shore wings to add the extra length required.

C. Trap Netting-Under the Ice

(a) Preparation

The trap nets were set in the Little Waterhen River at the same location in the winter as in the summer. The procedure for setting trap nets under the ice is considerably different than for the summer operation.

Before installation, the nets were tied down two feet to produce a four foot deep trap net. This was necessary because of lower water levels and the prevailing ice layer.

Instead of the steel hooked anchors a supply of poles were prepared for the set. These poles were 20 feet long and 4 inches at the butt end. Anchor rings were tied about four feet from the small end. Also, six smaller poles were skinned as supports for the lead.

Other equipment required for the net set included a jigger, needle bar, ice chisel, chain saw, a 12 foot grab hook, running line, shovels, sledge, axes and a supply of polypropylene rope.

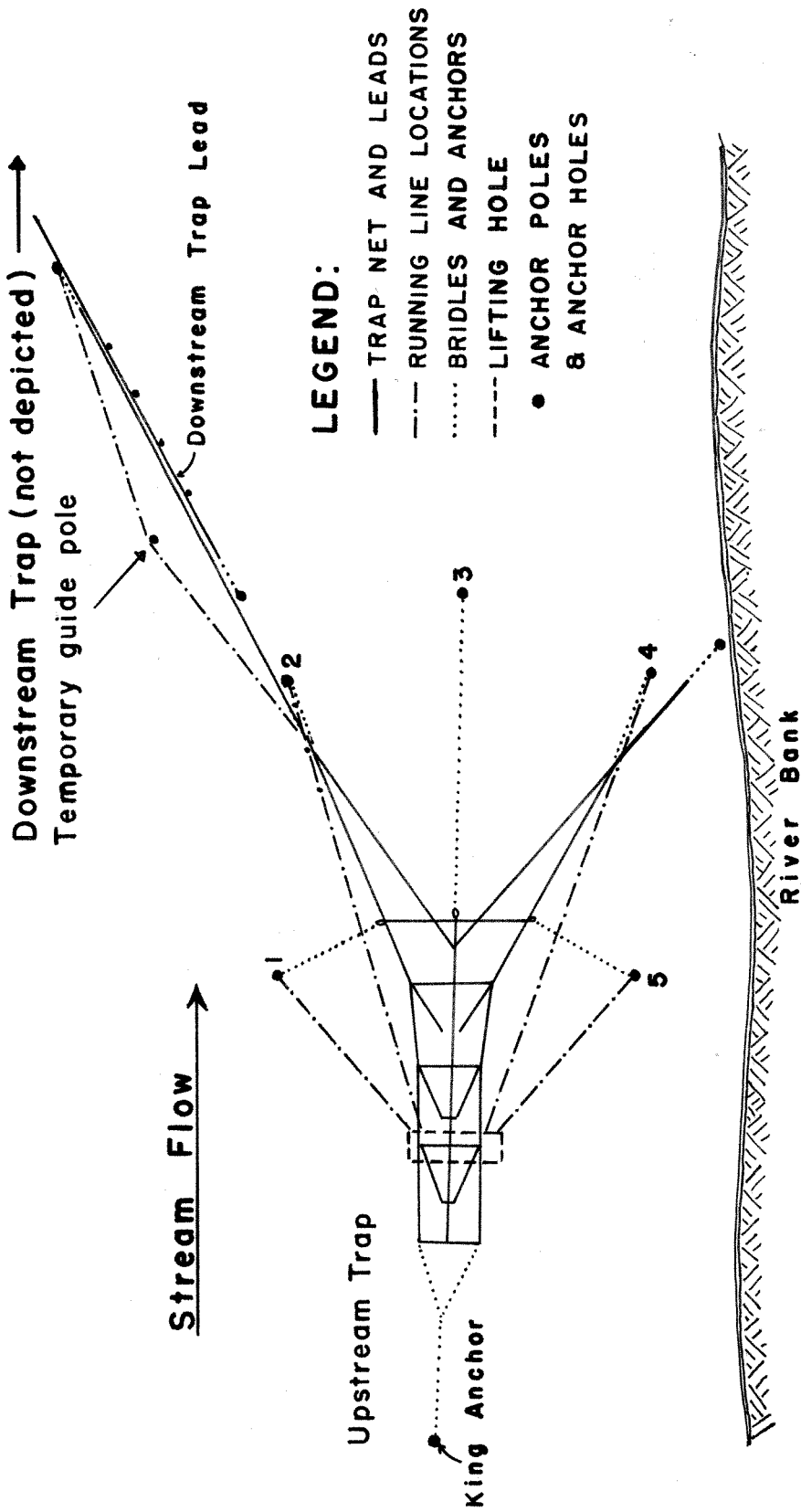

Figure 5. **TRAP NET INSTALLATION**
(WINTER OPERATION)

Waterhen River Fish Movement Study

1971 - 1972

Because of reduced water currents, the winter operation did not require use of a pulley tightener or a vertical spreader pole. A tightener could have caused considerable problem should binding occur in the pulleys. It was found that the net could be sufficiently stretched without the tightener arrangement.

(b) Setting the Trap Nets

Upstream Trap-Initially the trapping site had about seven feet of water covered by 12 to 18 inches of ice.

The trap net was stretched out on the ice surface at its proposed operational location. Anchor-holes 1 to 5 (Figure 5) were cut about twenty feet from the end of each trap net bridle. Only one anchor rope attached to each heart was required in the reduced stream flow.

A lifting-hole was marked off at the partition between the first and second crib. The lifting-hole, 7 feet by 2 feet, was then cut and cleared of ice.

Running lines were run from the lifting hole to each of the anchor-holes. The king anchor rope was not installed at this time.

The entire trap was laid out behind the lifting hole. Anchor ropes were tied to each bridle. Running lines from each anchor hole were tied to the appropriate anchor-ropes and pulled through to the anchor holes. Three men at anchor holes 2, 3 and 4 pulled simultaneously to pull the trap under the ice while a fourth man guided the trap down through the lifting hole. They stopped pulling when the junction of the first and second crib

reached the lifting hole. The anchor ropes tied to each heart of the trap were pulled up through anchor holes 1 and 5.

The anchor ropes were threaded through the rings of the anchor poles. The poles were driven into the river bottom taking care not to get the ropes tangled around the poles. These ropes were tightened in the order 3-2-4-1-5, taking care not to pull the trap any further through the lifting hole.

The running line for the king anchor was run from the king anchor hole to the lifting hole. The anchor rope was then pulled back through the king-anchor hole. The rope was threaded through the ring of the king anchor pole, (slightly larger pole than the others) which was then pounded securely into the river bottom.

The top spreader pole and bottom spreader pipe were pushed down through the lifting hole while one man was simultaneously tightening the king anchor line. The anchor lines were tightened and secured to each pole using half hitches.

Downstream Trap-When setting the downstream trap it was necessary to run the running lines from the anchor holes to the lifting hole (except for the king anchor, which was run from the lifting hole). This change in procedure was necessary because of the current.

Other than this difference, the setting procedure was the same as for the upstream trap.

(c) Installing the Leads

Two 150 foot leads were used for the winter operation.

The downstream trap lead was laid on the ice with one end of the lead directly over the end of the midstream wing. An anchor hole was cut in the ice about twenty feet beyond the upstream end of the lead. Six holes were cut in a straight line along the length of the lead. These holes were for the lead support poles. A running line was run from the anchor hole downstream towards the wing. The line was picked up at each of the holes and a skinned pole was pounded in on the downstream side of the line.

A hole was cut at the end of the midstream wing. The end of the wing was pulled through and seamed to the end of the lead. The lead rope was pulled through to the lead's anchor hole and the lead was pulled in under the ice. Both lead and wing anchors were tightened.

The upstream trap lead was installed with the same procedure except the running line was run around the upstream side of a temporary guide pole (Figure 5) installed about ten feet upstream of the downstream lead. The running lines continued downstream to a hole about four feet from the downstream lead where it was picked up. The anchor line for the lead was pulled through and finally the lead was pulled under the ice. The temporary guide pole was then removed to allow the lead to drift down against the downstream lead. The anchor lines were tightened and secured.

To get the shore leads as tight to the bank as possible, two steel rings were tied to the anchor poles about four feet apart. Two lines were used, one through the top ring to the cork line of the lead and one through the bottom ring to the lead line. This made it possible to pull the lead tight to the pole (no bridle was used).

(d) Lifting the Winter Traps

The same procedure was used for lifting both traps.

The ice cover that developed over the lifting hole was cleaned out each day the traps were lifted. The king anchor line was carefully broken free of the ice build up in the anchor hole and the tension on the trap released. The slackened line was secured to the king anchor pole.

The lifting line was pulled out of the lifting hole and secured to block off the funnel in the second crib. The spreader pole and pipe were pulled back to the lifting hole and lifted out of the water. The pole was secured to the building with pieces of side line. The zipper was opened and the fish dipped from the crib.

When winter fishing, any fish trapped in the first crib could not be removed. After the fish had been removed, the zipper was closed. The spreader pole and pipe were pushed back under the ice and the king anchor was drawn taut and secured.

(e) Trap Netting Problems

Before setting was completed some of the running lines were left in overnight before being used. The following day they had frozen in and new lines had to be run. Weighting the lines would have prevented this.

When some of the holes were cut, large blocks of ice were pushed under the ice with the intention that the current would carry them downstream. Some of these blocks did not move sufficiently far downstream causing snagging problems when the traps were lifted. Some of these blocks had to be chopped out and removed.

The polypropylene lifting lines occasionally floated up and became frozen to the underside of the ice. This problem was solved by attaching weights to these lines.

As the winter progressed, the ice thickened and water depth decreased. This caused freezing-in problems with the top spreader pole, float cans and portions of the last crib. Periodic tying down of the pole was necessary. Some of the cans were either punctured or removed to eliminate the problem.

D. Handling the Fish

(a) Walleye

Walleyes were tagged by inserting a floy tag into the left side at the base of, and posterior to, the spiny dorsal fin. The tagged walleyes were released on the respective sides of each trap net that allowed the fish to continue moving in its original direction of travel. During the open water operation, the walleyes were retained, until tagged, in a tub of water. A maximum of seven fish were held in the tub at any one time. The water was changed after each group of fish were tagged and released. In the winter, the change of water was less frequent but the fish were usually not held longer than five minutes before being released.

(b) Other Species

All other fish species caught were tallied. During the winter operation, most of the rough fish (white sucker, Catostomus commersoni (Lacépède), shorthead redhorse, Moxostoma macrolepidotum (Lesueur), and burbot, Lota lota (Linnaeus), were marketed under a commercial permit held by Mr. R. Adams, Skownan, Manitoba. During the summer, these species were released. The remaining species of fish were released as described above for walleyes.

RESULTS

For most Little Waterhen River species, abundance was greatest in the open water period. Figures 6 to 14 show averaged daily catch frequencies for each species and month. It should be noted that results for January, April, May and June, 1972 are based on only 13, 11, 26 and 6 days respectively (Table 1).

Walleye-During the entire project 5,349 walleyes were caught in the traps; 1,394 moving upstream and 3,955 downstream. Of these fish, 1,327 were tagged from the upstream trap and 3,653 from the downstream trap for a total of 4,980 tagged fish. The difference of 369 fish was caused by the recurrence of tagged fish in the traps (Table 1).

Greatest walleye numbers were captured during the summer and fall of 1971 (Figure 6). During this period, 4,676 walleyes were captured which represents 87.5% of the total number caught during the project. Most of these (78.7%) were captured in the downstream trap.

During April, 1972, prior to break up, walleye movement was mainly downstream but when the traps were reset in open water on May 3, 1972, walleye movement was largely upstream. On May 4, the upstream trap was so full of fish it was impossible to lift and the zipper had to be opened underwater allowing the fish to swim free. No tally or tagging was possible. Most of these fish were suckers but numerous walleyes were also observed. It is possible that most of the spring upstream walleye movement was missed during the April 11 to May 4, 1972 period when trap nets were removed.

Table 1. Monthly walleye tagging from upstream and downstream traps, Little Waterhen River, 1971 and 1972.

Month/Year	Days Fished	Number of walleyes tagged			Av. No./day	Trap recaptures
		Upstream	Downstream	Total		
June 1971	29	176	201	337	13.0	20
July 1971	30	104	232	336	10.9	21
August 1971	31	169	728	897	29.0	37
Sept. 1971	30	320	966	1286	42.9	92
October 1971	31	186	1288	1474	47.5	136
1971 Total	151	955	3415	4370	28.9	306
Jan. 1972	13	24	2	26	2.0	7
Feb. 1972	29	84	17	101	3.5	12
Mar. 1972	31	148	49	197	6.4	22
Apr. 1972	11	10	44	54	4.9	8
May 1972	26	68	80	148	5.7	7
June 1972	6	38	46	84	14.0	7
1972 Total	116	372	238	610	5.3	63
GRAND TOTAL	267	1327	3653	4980	18.7	369

The June run of walleyes in 1972 was about evenly divided between the upstream and downstream traps, with 7 and 8 fish per day, respectively.

Northern Pike-A total of 4,860 pike, Esox lucius, (Linnaeus), were captured from both traps for the whole project with 74.5% being caught in the downstream trap and 25.5% in the upstream. As for walleyes, part of the upstream movement may have been missed. The pike run remained fairly constant throughout the project except for the month of March, 1972, at which time they increased to about forty-five fish per day in the downstream trap (Figure 7).

Sauger-An insignificant number of saugers, Stizostedion canadense, (Smith), were caught during the project. Only 44 were captured and 20 of these were caught in the downstream trap during May of 1972 (Figure 8).

Lake Whitefish-Throughout most of the year, whitefish Coregonus clupeaformis, (Mitchill), movements were very light (Figure 9). During September and October of 1971, 640 were captured in the upstream trap which represented almost 87% of the 737 whitefish caught during the project. Only 20 whitefish were captured in the downstream trap throughout the year.

Cisco (Tullibee)-The cisco, Coregonus sp . catch totalled 3,169 fish for the whole project, and 81% of them were captured in the downstream trap.

A strong upstream movement of ciscoes was observed during September and October, 1971. There was equally heavy catches in the downstream trap during that period. However, a moderately strong downstream movement of ciscoes occurred during the winter operation. This was followed by an increased upstream movement during May and June of 1972 (Figure 10).

The cisco catch was composed almost entirely of a dwarf form that from cursory examination possessed characteristics most like that of the bloater, C. hoyi. The bloater has a long spawning period that may extend into March (Scott and Crossman, 1973) which coincides with downstream results (Figure 10).

Yellow Perch-Only 492 perch, Perca flavescens (Mitchill), were captured during the project. Perch movement was light and random throughout most of the year. A moderately strong downstream movement was observed during May when 250 perch were captured in the downstream trap in contrast to April when none were caught (Figure 11).

Goldeye-Only 164 goldeye, Hiodon alosoides (Rafinesque), were captured and 160 of these were caught during the summer of 1971.

Suckers-The suckers captured during the projects were comprised of two species; the white sucker and shorthead sucker. No separate tally of each species were kept, however, white suckers represented the highest percentage of the total catch (approximately 95%).

Suckers were the most numerous fish caught in the trap; more than 133,000 suckere were captured. The downstream sucker run totalled 78,236 or 58.5% of the total catch. The heaviest movements of suckers occurred in February and March of 1972 when a strong upstream migration was recorded (Figure 13). The highest recorded

FIGURE 6

WALLEYE PRODUCTION

LITTLE WATERHEN RIVER TRAP NETS

JUNE 1971 - JUNE 1972

☐ — UPSTREAM TRAP

▨ — DOWNSTREAM TRAP

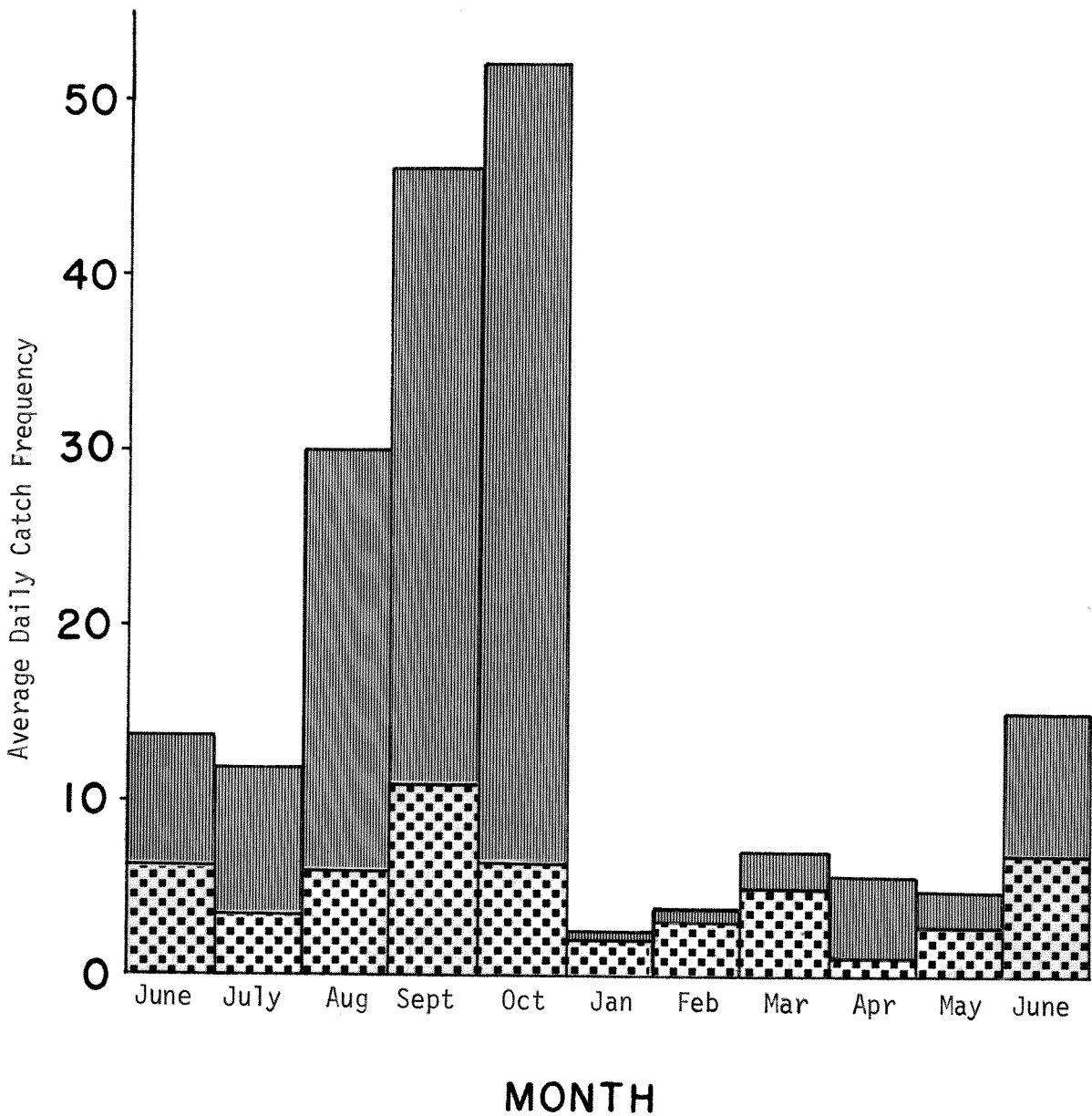

Figure 7

NORTHERN PIKE PRODUCTION LITTLE WATERHEN RIVER TRAP NETS

JUNE 1971 - JUNE 1972

☒ — UPSTREAM TRAP

▨ — DOWNSTREAM TRAP

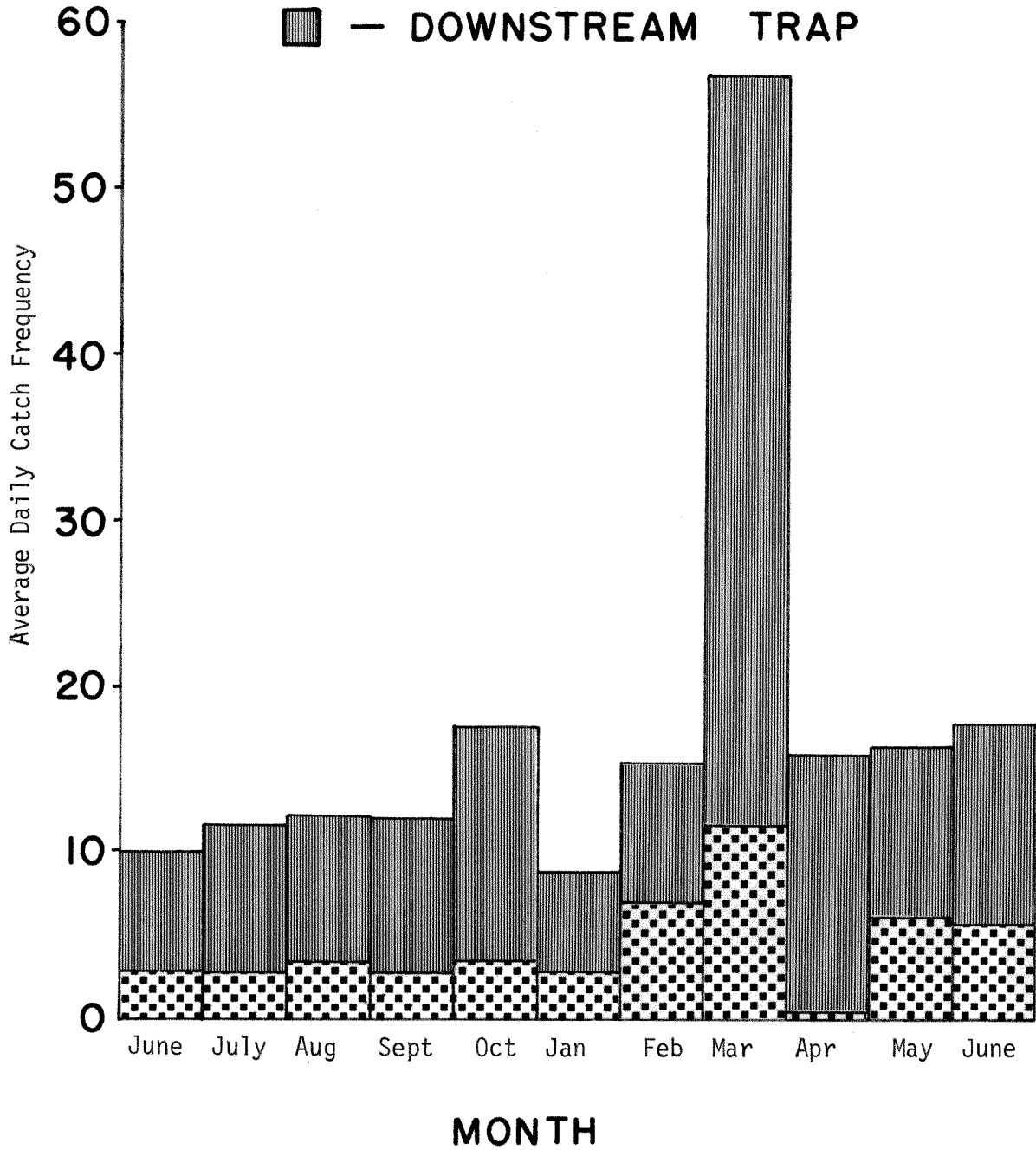

Figure 8

SAUGER PRODUCTION

LITTLE WATERHEN RIVER TRAP NETS

JUNE 1971 - JUNE 1972

☐ — UPSTREAM TRAP
▨ — DOWNSTREAM TRAP

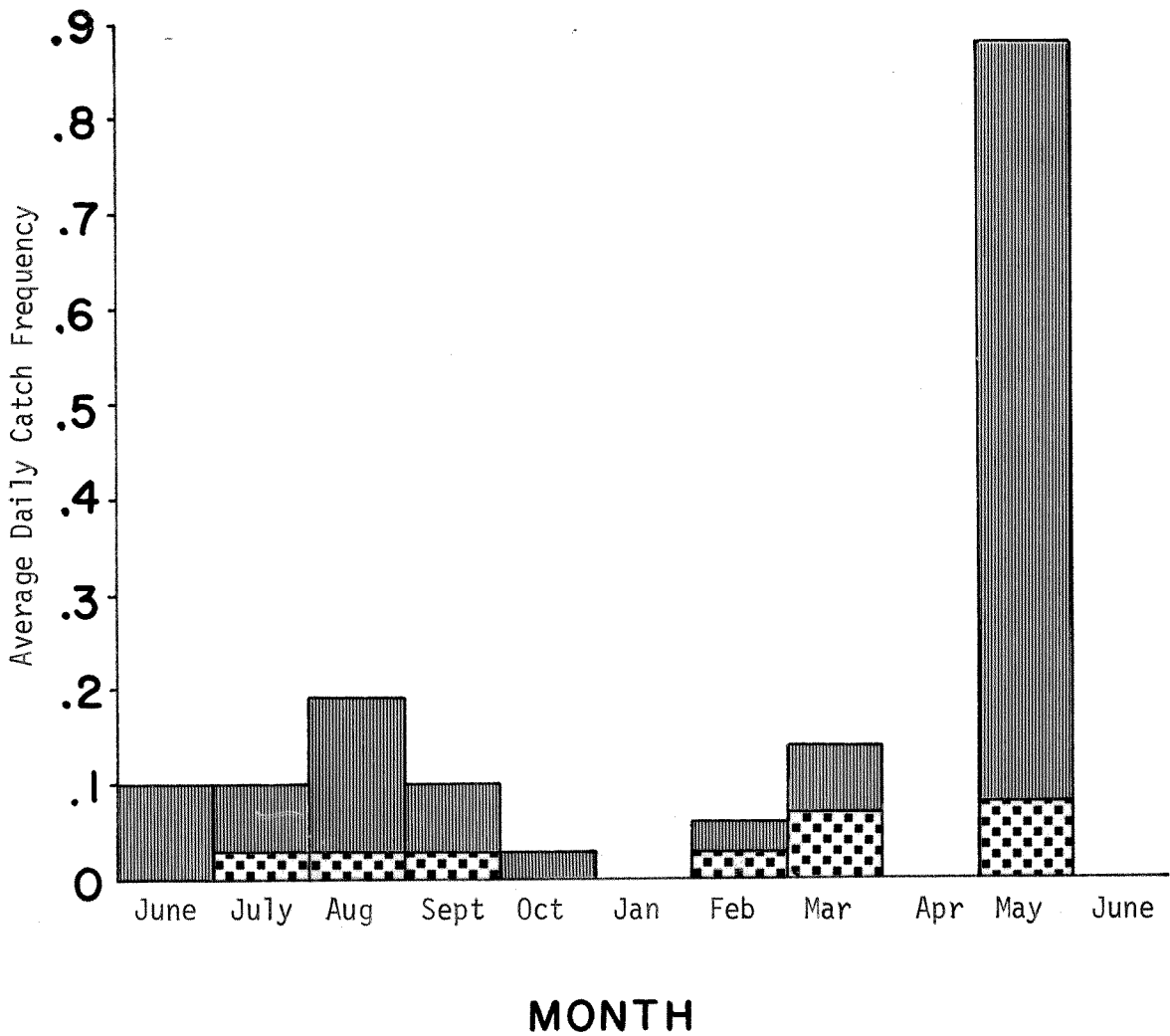

Figure 9

WHITEFISH PRODUCTION

LITTLE WATERHEN RIVER TRAP NETS

JUNE 1971 - JUNE 1972

☒ - UPSTREAM TRAP
▨ - DOWNSTREAM TRAP

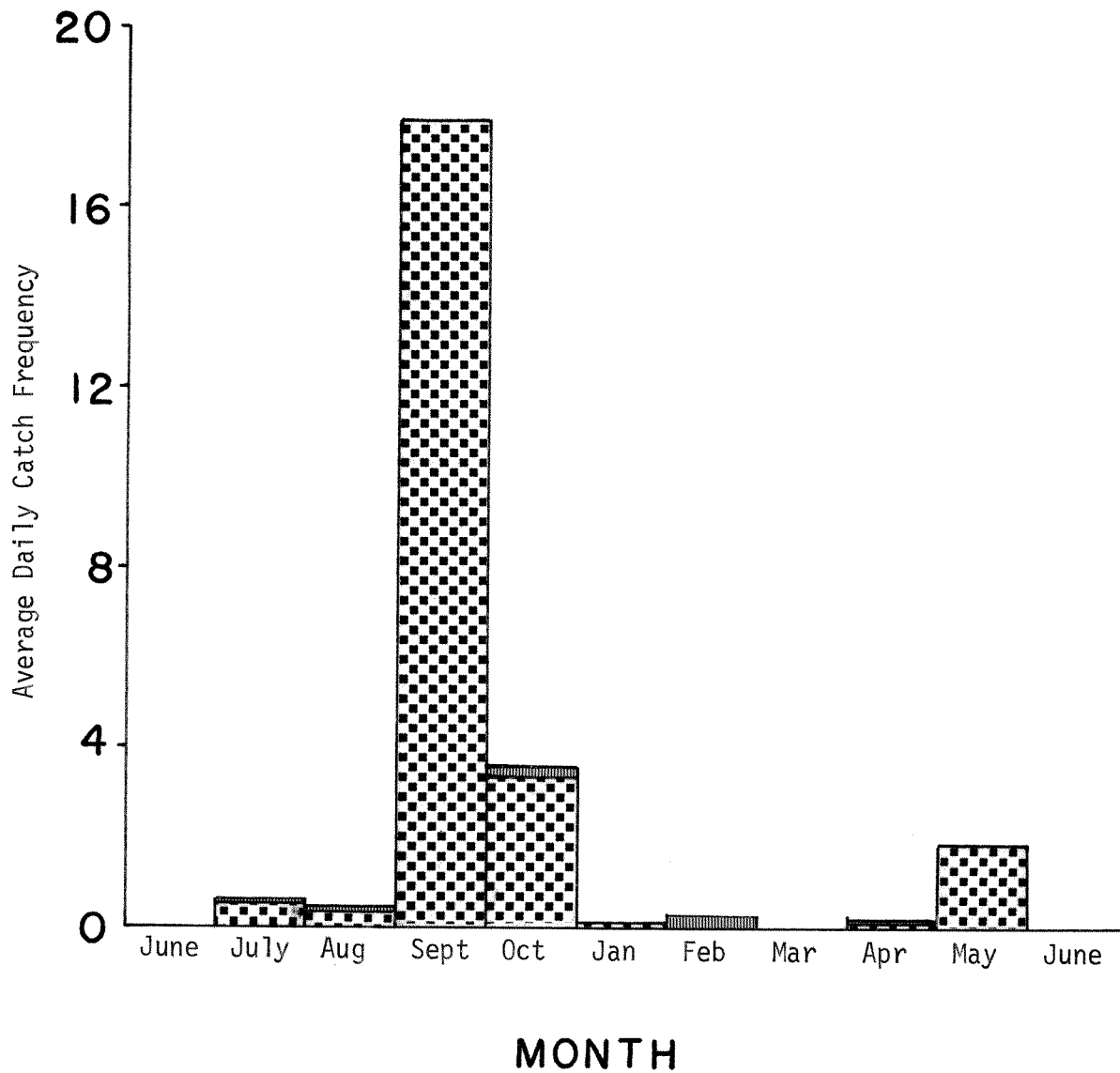

Figure 10

CISCO (TULLIBEE) PRODUCTION

LITTLE WATERHEN RIVER TRAP NETS

JUNE 1971 - JUNE 1972

☒ — UPSTREAM TRAP

▨ — DOWNSTREAM TRAP

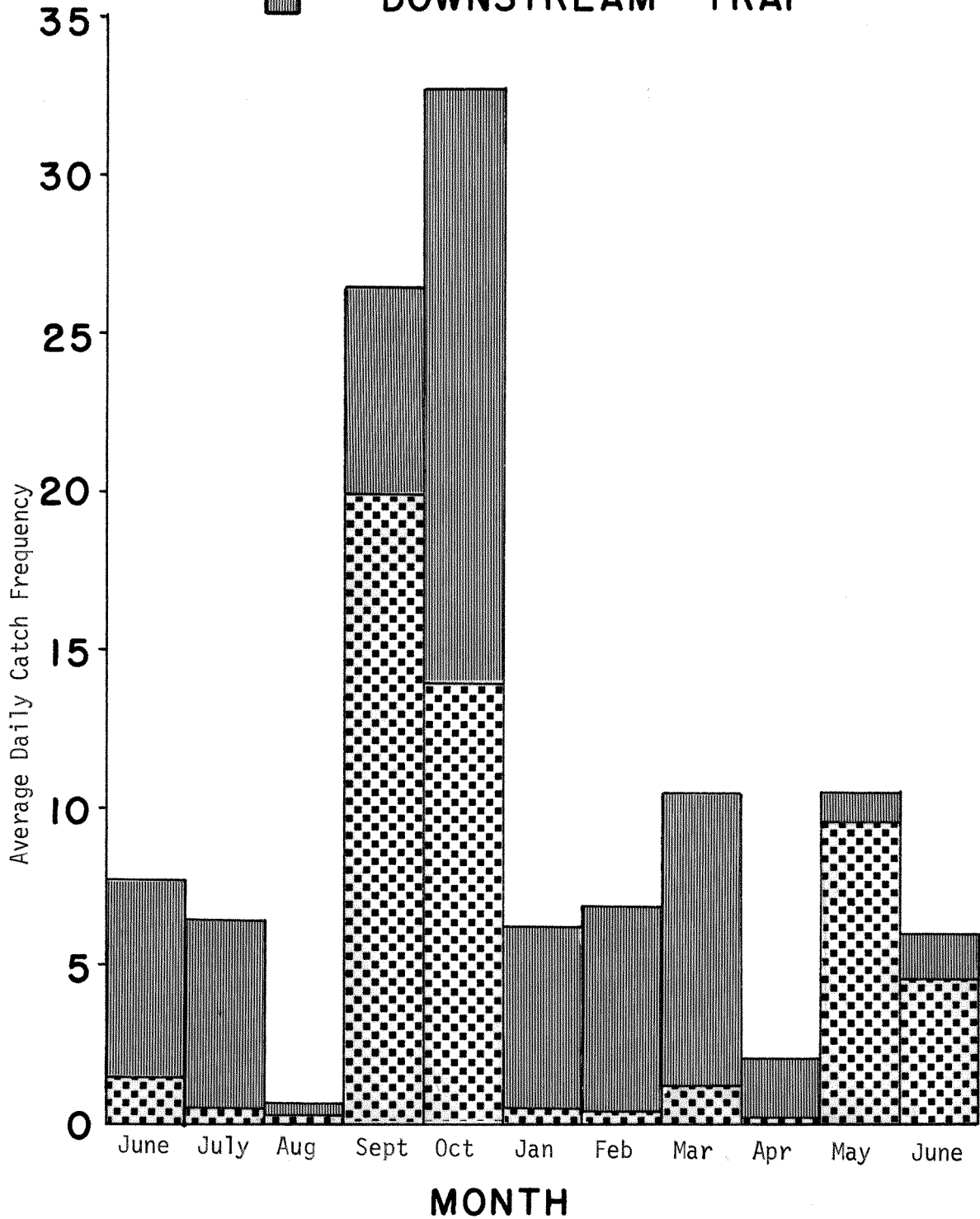

Figure 11

YELLOW PERCH PRODUCTION

LITTLE WATERHEN RIVER TRAP NETS

JUNE 1971 - JUNE 1972

☐ — UPSTREAM TRAP
▨ — DOWNSTREAM TRAP

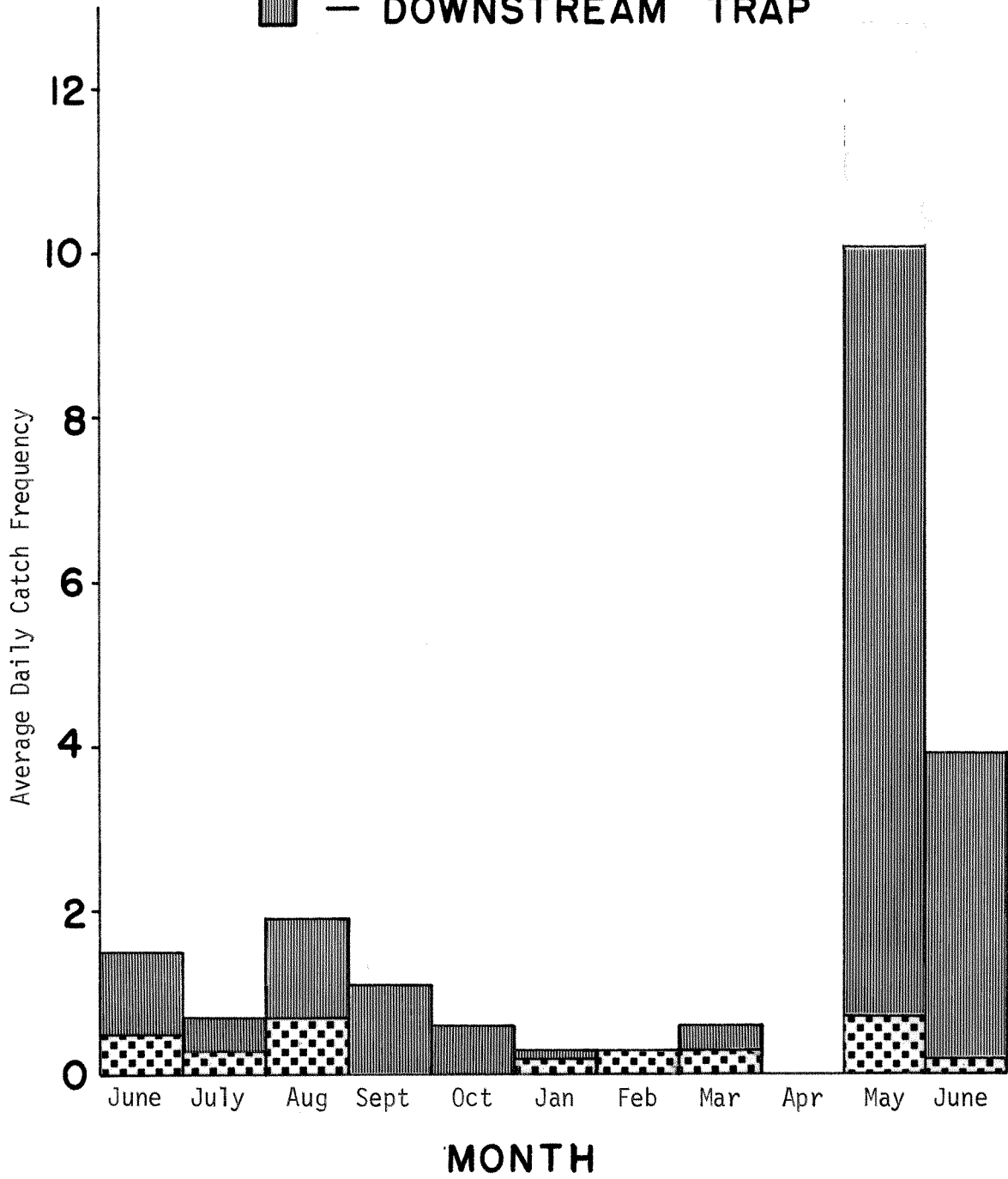

Figure 12

GOLDEYE PRODUCTION

LITTLE WATERHEN RIVER TRAP NETS

JUNE 1971 - JUNE 1972

☐ — UPSTREAM TRAP
▨ — DOWNSTREAM TRAP

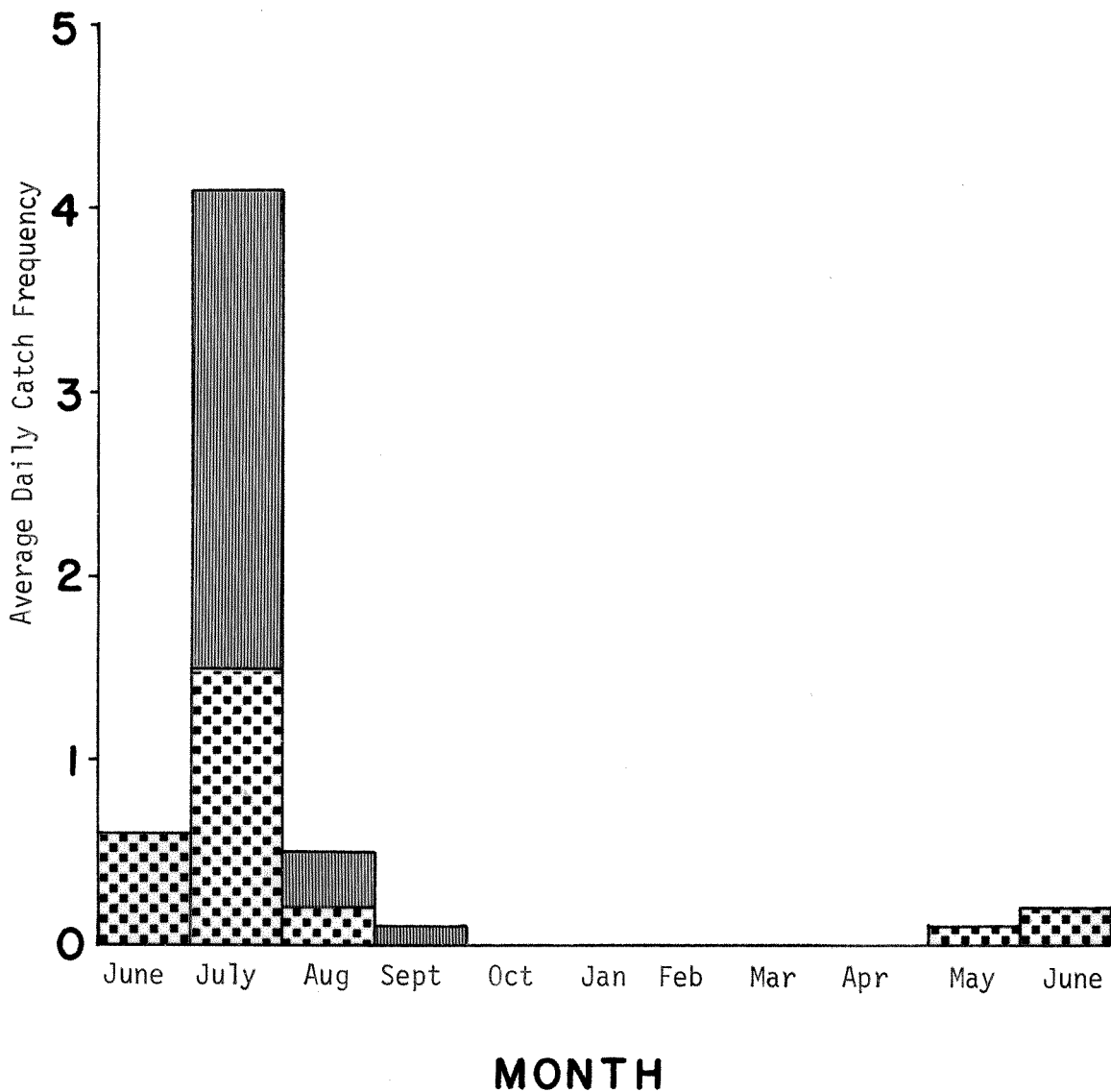

Figure 13

SUCKER PRODUCTION

LITTLE WATERHEN RIVER TRAP NETS

JUNE 1971 - JUNE 1972

☐ — UPSTREAM TRAP

▨ — DOWNSTREAM TRAP

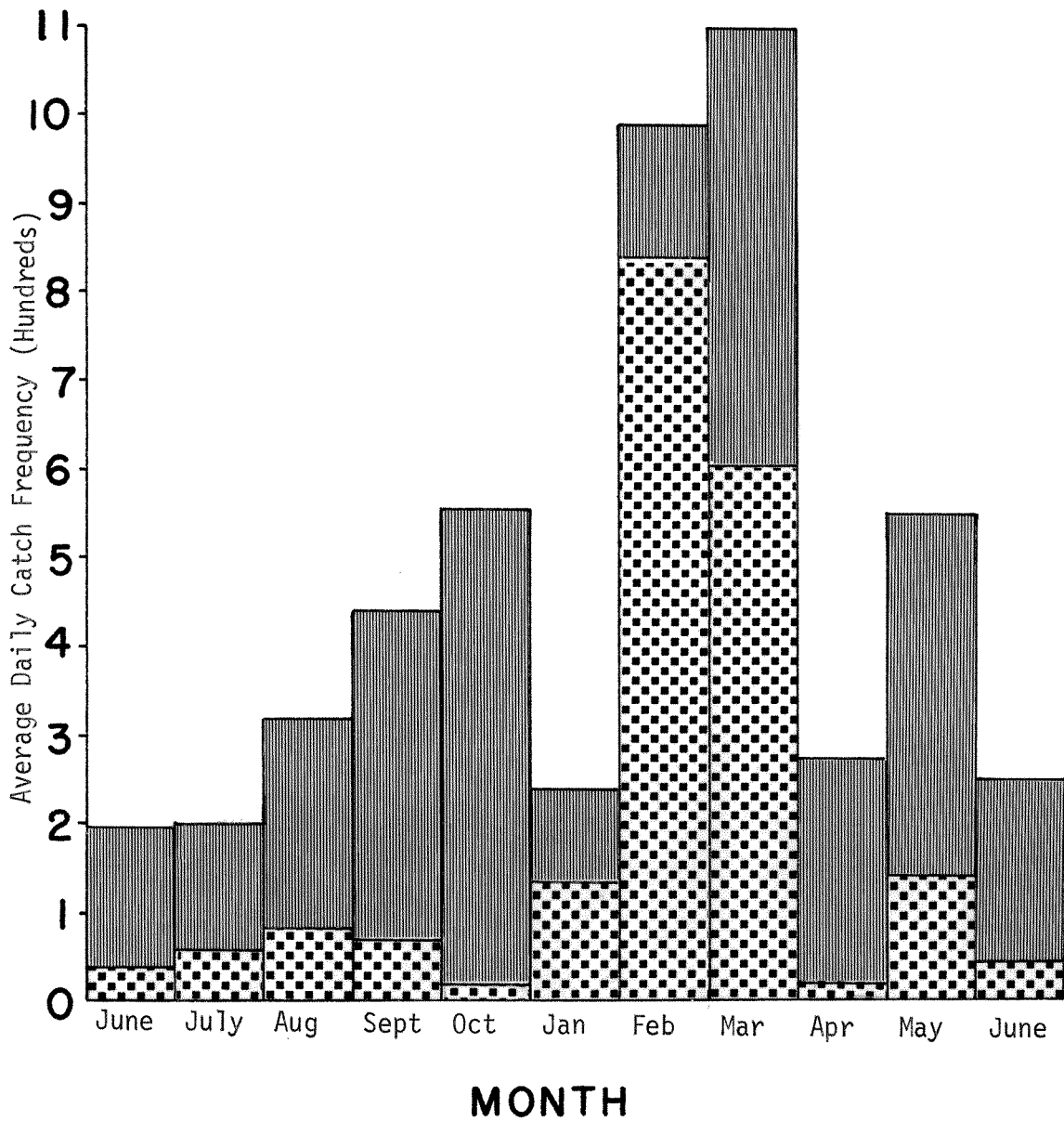

Figure 14

BURBOT PRODUCTION

LITTLE WATERHEN RIVER TRAP NETS

JUNE 1971 - JUNE 1972

▣ — UPSTREAM TRAP
▤ — DOWNSTREAM TRAP

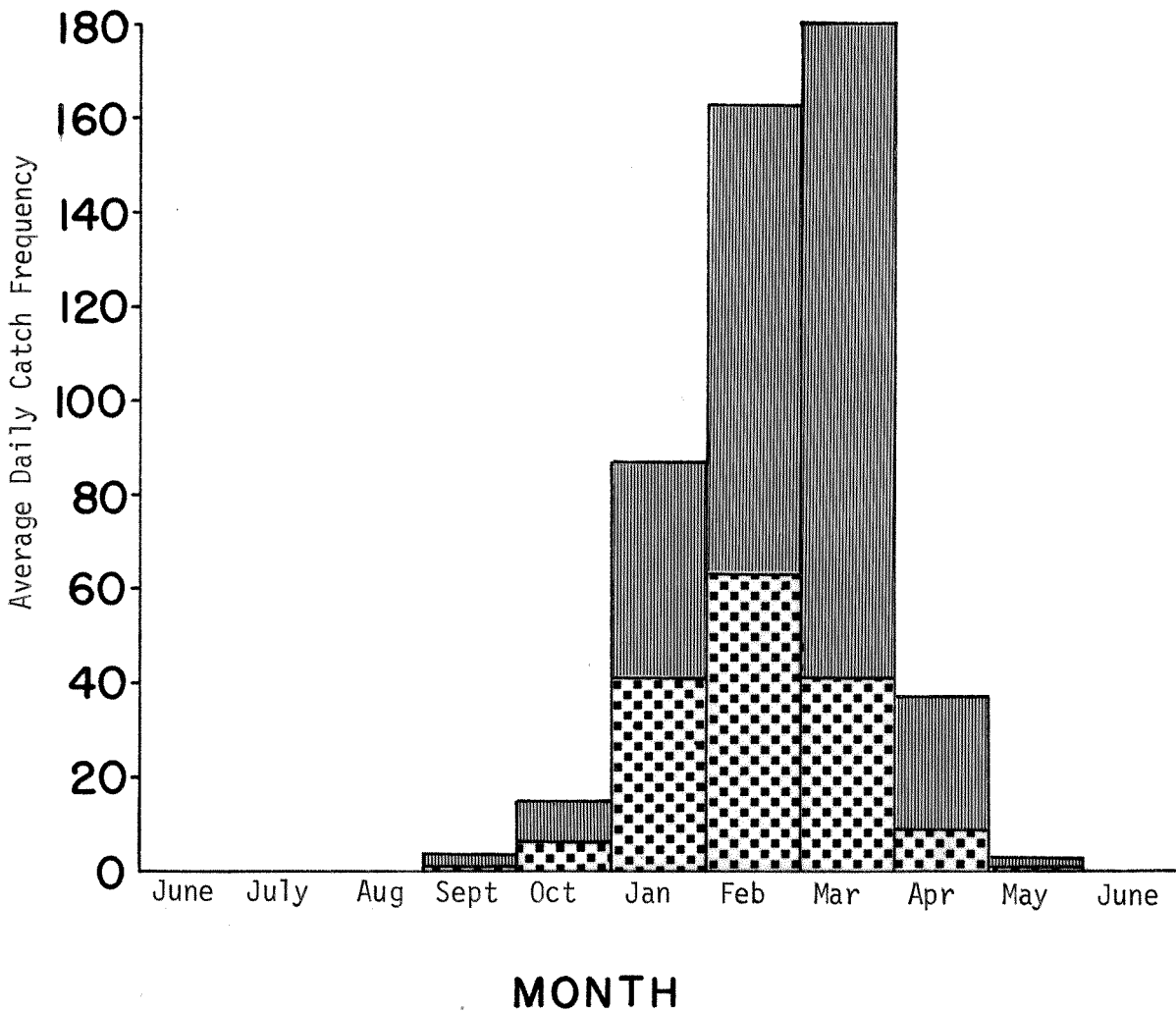

upstream movement took place in February when 24,184 suckers were tallied. In March some fish were returning to Lake Waterhen amid a strong upstream run. Most of the winter caught suckers were marketed. On May 4 (first day after nets were set in open water in the spring of 1972), an extremely strong upstream movement of suckers was observed. A tally of these fish was not possible because the traps were too full to lift, as explained under the walleye section.

Burbot-During February and March, 7,699 burbot were tallied from the downstream trap and 3,049 in the upstream trap. The whole project realized a total burbot catch of 12,389 fish; 69% were captured in the downstream trap.

Major burbot movements occurred in the late fall, winter and early spring. During the other four months a total of 38 burbot were captured. This small catch could not be meaningfully graphed as an average daily catch in Figure 14.

Other Species-Four other fish species were captured during the project, but their frequency of occurrence was low. Only five carp, Cyprinus carpio Linnaeus, were caught during June and July of 1971. One channel catfish, Ictalurus punctatus (Rafinesque), appeared in June the same year. Three quillback suckers, Carpionodes cyprinus (Lesueur), were caught in July, 1971. During June, July and August of 1971, 54 freshwater drums, Aplodinotus grunniens Rafinesque, were captured and 49 of these were moving upstream.

Tagging Results-Tag recovery data are provided in Tables 2 to 10. Tagged walleyes were captured within an area extending from Hunter's Island (east of Red Deer Point) on Lake Winnipegosis to the

Lake Manitoba Narrows. No recaptures were reported from below the Fairford Dam.

For discussion purposes the recovery area was partitioned into six general areas (Figure 15). Waterhen Lake recoveries came from that portion of Waterhen Lake which is within the legal commercial fishing boundaries (Table 5). The Waterhen Rivers includes that portion of the West Waterhen, Little Waterhen and East Waterhen rivers within the marked boundaries. Recovery data for the Waterhen River complex is provided in Table 6. Lake Manitoba West recoveries came that portion of Lake Manitoba West of the Crane River narrows (Table 7). Lake Manitoba East recoveries came from the remaining portion of the north end of Lake Manitoba extending as far south as the Lake Manitoba Narrows (Table 8). Recoveries for the Long Island Bay area are given in Table 9. Lake Winnipegosis recoveries came from the remaining portion of Lake Winnipegosis within the limits of the designated boundaries (Table 10).

Waterhen Lake reported that highest number of walleye recaptures (22.8% of the total tagged) followed by the Waterhen River (6.8%). The remaining four areas produced only 4.3% of the total tagged (Tables 2 and 4).

Of the 4,980 walleyes tagged, 1,808 (36%) were recovered between 1971 and 1976. Only 1,686 of the recaptured were returned with known recovery dates (Tables 3 and 4). Lake Manitoba and Lake Winnipegosis commercial fisheries were the most lax at providing complete recapture information.



Figure 15. Areas of walleye recaptures

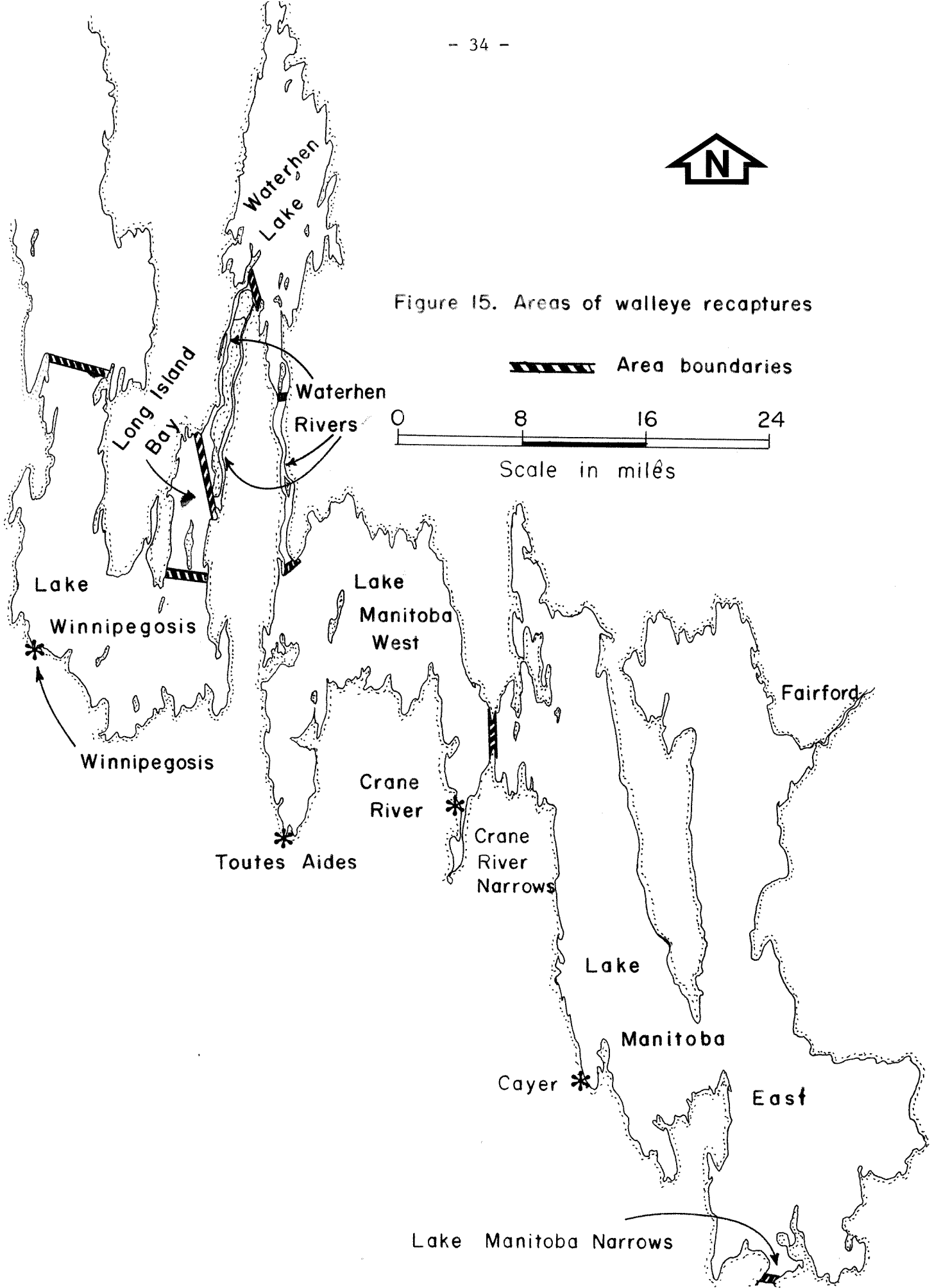

Table 2. Walleye recaptures* expressed as percent of number tagged for various locations and each month of tagging

Month Released	Number Tagged	Recovery areas										Total	
		Waterhen Lake	Waterhen Rivers	Lake West	Lake Manitoba	Lake East	Long Bay	Long Island	Lake Winnipegosis	Lake Winnipegosis	Total		
June 1971	377	3.4	5.6	1.1	0.3	0.3	0.3	0.3	0.6	0.7	0.6	0.6	10.7
July 1971	336	9.2	6.5	3.3	0.3	0.3	0.3	0.3	0.6	0.6	0.6	0.6	20.5
Aug. 1971	897	13.0	10.9	1.8	0.4	0.4	0.4	0.4	0.9	0.7	0.6	0.6	27.6
Sept. 1971	1286	26.5	8.0	3.0	0.4	0.4	0.4	0.4	0.8	0.7	0.7	0.7	39.4
Oct. 1971	1474	39.3	3.5	2.4	0.3	0.3	0.3	0.3	1.2	0.2	0.2	0.2	46.9
Jan./Feb. 1972	127	10.2	6.3	1.6	0.8	0.8	0.8	0.8	-	0.8	0.8	0.8	19.7
Mar. 1972	197	10.2	7.6	4.6	1.0	1.0	1.0	1.0	-	-	-	-	23.4
April 1972	54	11.1	9.3	3.7	3.7	3.7	3.7	3.7	-	1.9	1.9	1.9	29.7
May 1972	148	6.8	8.1	6.8	0.7	0.7	0.7	0.7	-	0.7	0.7	0.7	23.1
June 1972	84	4.8	3.6	-	-	-	-	-	-	-	-	-	8.4
TOTAL	4980	22.8	6.8	2.6	0.5	0.5	0.5	0.5	0.8	0.4	0.4	0.4	33.9

*Recoveries include only those fish of know recovery dates.

Table 3. Monthly walleye tag recaptures relative to known and unknown date of recapture.

Month Year	# of Tag Recaptures Known dates	Number of Tag Recaptures--Unknown Dates										Total Recaptures
		Waterhen Lake	Waterhen Rivers	Waterhen Lake West	Waterhen Lake East	Manitoba Bay	Long Island	Lake Winnipegosis	Lake Winnipegosis	Recaptures		
June 1971	40	-	-	-	-	-	-	-	-	-	-	40
July 1971	69	-	-	6	-	6	-	6	-	6	1	82
Aug. 1971	248	-	3	6	1	32	10	300	-	-	-	300
Sept. 1971	509	4	7	14	1	13	-	548	-	-	-	548
Oct. 1971	692	-	1	8	-	9	-	710	-	-	-	710
Jan./Feb. 1972	25	-	-	-	-	-	-	25	-	-	-	25
Mar. 1972	46	-	-	-	-	-	-	46	-	-	-	46
April 1972	16	-	-	-	-	-	-	16	-	-	-	16
May 1972	34	-	-	-	-	-	-	34	-	-	-	34
June 1972	7	-	-	-	-	-	-	7	-	-	-	7
TOTAL	1686	4	11	34	2	60	11	1808	-	-	-	1808

Table 4. Numbers and percentages (in parenthesis) of annual recaptures (with known dates) in six tag recapture areas.

Recovery area	Annual number of recaptures						Total
	1971	1972	1973	1974	1975	1976	
Waterhen Lake	869(79.7)	214(47.3)	41(40.2)	5(26.3)	3(20.0)	2(28.6)	1134(67.3)
Waterhen Rivers	150(13.7)	135(29.9)	40(39.2)	6(31.6)	5(33.3)	2(28.6)	338(20.0)
Lake Manitoba West	41(3.8)	58(12.8)	17(16.7)	8(42.1)	3(20.0)	2(28.6)	129(7.7)
Lake Manitoba East	10(0.9)	7(1.5)	4(3.9)	-	2(13.3)	1(14.3)	24(1.4)
Long Island Bay	13(1.2)	26(5.8)	-	-	-	-	39(2.3)
Lake Winnipegosis	8(0.7)	12(2.7)	-	-	2(13.3)	-	22(1.3)
TOTAL	1091(64.7)	452(26.8)	102(6)	19(1.1)	15(0.9)	7(0.4)	1686(100)

Table 5. Waterhen Lake tag recaptures from each month of tagging from June, 1971 to June, 1972. Recaptures recorded for each quarterly period in each year.

*% of recaptures is the percentage of the total recaptures from each month of tagging - e.g. in June, 1971, 40 tags were recaptured and 13 of these or 32.5% were recaptured in Waterhen Lake.

Tagging Month	1971												1972												1973												1974												1975												1976												TOTAL	
	1	2	3	4	1	2	3	4	1	2	3	4	1	2	3	4	1	2	3	4	1	2	3	4	1	2	3	4	1	2	3	4	No.	% of recaptures																																								
June 1971	x	1	3	8	1																												13	32.5																																								
July 1971	x	x	10	19	2																												31	44.9																																								
Aug. 1971	x	x	12	83	15	1	3																										117	47.2																																								
Sept. 1971	x	x	4	253	40	1	4	24	3	2	7	1	1																			341	66.8																																									
Oct. 1971	x	x	x	476	62			31	3		5	2																				579	83.7																																									
Jan./Feb. 1972	x	x	x	x	1			9	1		2																					13	52.0																																									
Mar. 1972	x	x	x	x				8	8	1	1																					20	43.5																																									
Apr. 1972	x	x	x	x	x			4	1	1																						6	37.5																																									
May 1972	x	x	x	x	x	2	3	2																								10	29.4																																									
June 1972	x	x	x	x	x		2																									4	57.1																																									
TOTAL	1	29	839	121	1	8	84	18	-	2	21	4	-	-	1	-	-	-	-	3	1	-	-	1	1134											67.2																																						

Table 6. Waterhen rivers tag recaptures from each month of tagging from June, 1971 to June, 1972. Recaptures recorded for each quarterly period in each year.

Tagging Month	1971			1972			1973			1974			1975			1976			TOTAL			
	1	2	3	4	1	2	3	4	1	2	3	4	1	2	3	4	1	2	3	4	No.	% of recaptures
June 1971	x	3	12	2	2	2															21	52.5
July 1971	x	x	14	2	4		2														22	31.9
Aug. 1971	x	x	70	8	14	4	1														98	39.5
Sept. 1971	x	x	18	10	28	23	2	8	6	2	1										103	20.2
Oct. 1971	x	x	x	11	19	9	1	1	5	3	1										51	7.4
Jan./Feb. 1972	x	x	x	x	5	1				1											8	32.0
Mar. 1972	x	x	x	x	4	2	1	2	4		1										15	32.6
Apr. 1972	x	x	x	x	x	3					1										5	31.3
May 1972	x	x	x	x	x	4	3														12	35.5
June 1972	x	x	x	x	x	1	2														3	42.9
TOTAL	3	114	33	-	84	46	5	-	12	22	6	-	5	1	-	-	1	-	-	2	338	20.1

Table 7. Lake Manitoba West tag recaptures from each month of tagging from June, 1971 to June, 1972. Recaptures recorded for each quarterly period in each year.

Tagging Month	1971			1972			1973			1974			1975			1976			TOTAL			
	1	2	3	4	1	2	3	4	1	2	3	4	1	2	3	4	1	2	3	4	No.	% of recaptures
June 1971	x			2			2														4	10.0
July 1971	x	x	1	3	5	1			1												11	15.9
Aug. 1971	x	x	1	8	2	5															16	6.5
Sept. 1971	x	x	1	19	4	1	4	1	2	1		2									39	7.7
Oct. 1971	x	x	x	6	3	8	4	7	3	2	1	1	1	1							36	5.2
Jan./Feb. 1972	x	x	x	x						1											2	8.0
Mar. 1972	x	x	x	x	x	2	2		1	1		1	1	1							9	19.6
Apr. 1972	x	x	x	x	x		1	1													2	12.5
May 1972	x	x	x	x	x	1	1		3	1						2	1			1	10	29.4
June 1972	x	x	x	x	x																-	-
TOTAL			3	38	14	12	12	20	8	5	4	3	2	3	2	1	1	1	1	1	129	7.7

Table 8. Lake Manitoba East tag recaptures from each month of tagging from June, 1971 to June, 1972. Recaptures recorded for each quarterly period in each year.

Tagging Month	1971			1972			1973			1974			1975			1976			TOTAL	No.	% of recaptures
	1	2	3	4	1	2	3	4	1	2	3	4	1	2	3	4	1	2			
June 1971	x			1																1	2.5
July 1971	x	x		1																1	1.4
Aug. 1971	x	x	x	3	1															4	1.6
Sept. 1971	x	x		3	1			1												7	1.4
Oct. 1971	x	x	x	2		1														5	0.7
Jan/Feb. 1972	x	x	x	x																1	4.0
Mar. 1972	x	x	x	x		1														2	4.3
Apr. 1972	x	x	x	x	x	1									1					2	12.5
May 1972	x	x	x	x	x															1	2.9
June 1972	x	x	x	x	x	x														-	-
TOTAL				10	2	2	3	2	2	2	2	2	2	1	1	1	1	1	1	24	1.4

Table 9. Long Island Bay tag recaptures from each month of tagging from June, 1971 to June, 1972. Recaptures recorded for each quarterly period in each year.

Tagging Month	1971			1972			1973			1974			1975			1976			TOTAL	No. % of recaptures		
	1	2	3	4	1	2	3	4	1	2	3	4	1	2	3	4	1	2			3	4
June 1971	x			1																	1	2.5
July 1971	x	x	1		1																2	2.9
Aug. 1971	x	x		1	7																8	3.2
Sept. 1971	x	x			10																10	2.0
Oct. 1971	x	x	x	10	8																18	2.6
Jan./Feb. 1972	x	x	x	x																	-	-
Mar. 1972	x	x	x	x																	-	-
Apr. 1972	x	x	x	x	x																-	-
May 1972	x	x	x	x	x																-	-
June 1972	x	x	x	x	x																-	-
TOTAL			1	12	26																39	2.3

Table 10. Lake Winnipegosis tag recaptures from June, 1971 to June, 1972. Recaptures recorded for each quarterly period in each year.

Tagging Month	1971			1972			1973			1974			1975			1976			TOTAL			
	1	2	3	4	1	2	3	4	1	2	3	4	1	2	3	4	1	2	3	4	No.	% of recaptures
June 1971	x																				-	-
July 1971	x	x		1	1																2	2.9
Aug. 1971	x	x		3	2																5	2.0
Sept. 1971	x	x		6	2																9	1.8
Oct. 1971	x	x	x	1	2																3	0.4
Jan./Feb. 1972	x	x	x	x																	1	4.0
Mar. 1972	x	x	x	x																	-	-
Apr. 1972	x	x	x	x	x	1															1	6.3
May 1972	x	x	x	x	x	1															1	2.9
June 1972	x	x	x	x	x																-	-
TOTAL				8	8	4										2					22	1.3

DISCUSSION

Valid specific trends in upstream and downstream fish movements cannot be concluded as the data must be considered relative to several limitations. For example, many fish species (walleyes, suckers, pike, etc.) found in this watershed normally spawn in April and May and will travel upstream during this period. However, ice breakup prevented netting operations during the prime fish spawning period of April 11 to May 4, 1972. Most of the walleyes (73.9%), for example, were captured in the downstream trap which could be interpreted to mean they came out of Lake Winnipegosis. As likely, most walleyes (as well as other spring spawners) went upstream when the nets were out of the water, spawned and slowly moved downstream throughout the summer while the traps were in the river and water levels were on the decline. Also, there are water connections between the Little Waterhen River and the West Waterhen River which would allow fish to enter one river and return in the other. In fact, some tagged walleyes came through the same trap net more than once; possibly indicating some cycling movement from one river to the other.

Perch movements which occurred in May (Figure 11) was likely associated with spawning activity. Many perch, however, could have passed through the leads undetected because of their size and therefore the perch movement was likely much greater than the data indicates.

Data from fall spawning fish, especially whitefish (Figure 9), may be equally deceptive. The nets were removed during freeze-up for the months of November and December. Whitefish that went upstream in September and October probably returned in November and/or December when the nets were out of the water.

Cisco movement in September and October, 1971 (Figure 10), was probably associated with spawning activity. They appeared to have remained in the river for a short period of time. Many ciscoes may have gone undetected because of the mesh size of the lead (as with perch).

Burbot spawn in late January and February (Hewson, 1955) and this correlates well with mid-winter catches (Figure 14). As this species was harvested along with suckers during the winter months the downstream movement at this time could be attributed to burbot movement from the West Waterhen River or from Lake Winnipegosis.

The mouth of the West Waterhen River at Waterhen Lake has more than one entrance, is closer to the main body of Waterhen Lake and has considerably greater flow than the Little Waterhen River. A greater number of upstream migrants may be attracted to the West Waterhen River yet some of those fish may return on the Little Waterhen River, since the two rivers are connected. Although this is only conjecture, it would account for the greater number of most fish species caught in the downstream trap. Additional evidence for this

relates to the fact that all suckers and burbot moving upstream were harvested and yet large numbers of these species were caught in the downstream trap. This also probably explains the increased pike production in the downstream trap during March, 1972 (Figure 7).

Movement of suckers was strongest in February and March, 1972. Apparently suckers and pike will move upstream in mid-winter if flows and dissolved oxygen levels are high.

Some downstream fish movement from Lake Winnipegosis may occur at times. However, none of the walleye tagging projects on Lake Winnipegosis, including Long Island Bay (at the outlet of Lake Winnipegosis leading to the Waterhen River system) have resulted in tag recoveries downstream of Lake Winnipegosis (Anon., 1976).

Table 2 shows the numbers of tagged walleye released during each month of tagging and the percentage of recoveries recorded for each area. It is interesting to note the increase in total percentage of recoveries for each month. As the project progressed the recovery rate increased (June to October, 1971). This may indicate a higher mortality rate at the beginning of the project when only 10.7% of the June tagged fish were recovered. This percentage increased for each successive month up to October when 46.9% were recovered. This "natural mortality" may be due to tag loss or to mortality resulting from handling. Tag loss would appear to be a likely cause possibly due to inexperienced personnel whose skill at tagging and handling fish gradually increased with time. Until April, 1972, the same

phenomenon held true for the 1972 tagging. A new group of personnel were conducting this tagging operation. The only exception to this trend occurred in May and June (especially June) when only 8.4% of the tagged fish were recovered. The small number of walleyes tagged in 1972 may be a factor but it appeared that June tagging in both years produced poor returns. Spawning walleyes may be more sensitive to handling and this may have resulted in higher mortality.

Because of intense exploitation by both the commercial and sport fishermen in the immediate area of tagging and during the tagging project, an obvious bias in tag return locations could be expected. Walleyes had insufficient opportunity to disperse before being caught. Almost 65% of the recaptures were returned in 1971 before the project was completed (Table 4), and 93.4% of these were caught either in Lake Waterhen or the Waterhen River system. In contrast, some walleyes quickly travelled a considerable distance, as one tagged fish was recovered 40 days after release about eighty miles from the tagging site.

Recaptures were sorted into quarterly recovery periods for each month of tagging in each area (Tables 5 to 10). Waterhen Lake results (Table 5) show a large number of recoveries during 1971; especially during the last quarter when the commercial season started. The 1972 fourth quarter recoveries on Waterhen Lake were only 10% of the number recaptured during the fourth quarter of 1971. In contrast, Lake Manitoba recaptures (Table 7) for the fourth

quarter of 1972 were 53% of the 1971 Lake Manitoba recaptures. An increased percentage of recoveries from Lake Manitoba during the period 1972 to 1974 may indicate that oscillating movement and mixing of unharvested Lake Manitoba - Waterhen area walleye stocks do occur, at a moderate rate and over an extended period of time.

Long Island Bay recorded the majority of recoveries for the Lake Winnipegosis area. A total of 99 tags were recovered in that area including the tags recovered with unknown recovery dates (Table 3). The 60 tags reported in Table 3 were caught during the summer and winter of 1971/72 but no actual month was reported and therefore were kept separate.

From the number of tags recovered in Lake Winnipegosis, it would appear that extensive northward walleye movement into Lake Winnipegosis was limited. Comparing Lake Winnipegosis and Lake Manitoba recoveries (Tables 3 and 4) it might be concluded that the tendency to migrate downstream is slightly stronger than upstream as 189 were caught in Lake Manitoba compared to 132 for Lake Winnipegosis. However, except for two tags recovered in 1975 by one commercial fisherman, Lake Winnipegosis recoveries were only received in 1971 and 1972 (Tables 9 and 10). After 1972, Lake Winnipegosis commercial fishermen appeared somewhat reluctant to return tags. Although this is somewhat conjectural, intentional retention of tags would lower the recovery rate. Also, in contrast to Lake Manitoba, few Lake Winnipegosis walleyes would spawn in the

Waterhen River complex; therefore, the upstream movement into Lake Winnipegosis could be considered surprisingly high.

It is apparent that walleye movement away from the tagging area was limited and somewhat random. Few definitive patterns of dispersal can be inferred from the data except for return walleye movement into the western portion of Lake Manitoba (2.6% of the total number released). This is not surprising, since a portion of Northern Lake Manitoba walleye populations probably spawn in the Waterhen River complex and then return to Lake Manitoba. In fact, an even larger recovery in Lake Manitoba would be expected which could suggest that Lake Manitoba walleyes supplement walleye harvests in the Lake Waterhen complex and Lake Winnipegosis. Other tagging studies are further evidence of a trend toward upstream walleye movement (Anon., 1976). For example, 1970 tagging at Toutes Aides on Lake Manitoba showed that 77 out of 525 walleyes moved out of Lake Manitoba into the Waterhen system and one walleye even moved into Lake Winnipegosis.

Between 1973 and 1975 walleyes and saugers were tagged at Cayer on Lake Manitoba. Up until March, 1976, only 16 recaptures were recorded and six of these came from parts of the East Waterhen River. Similar upstream movement is apparent from more recent Lake Manitoba tagging done by Eastern Region staff. Lake Manitoba tags have been returned from anglers and commercial fishermen in the Waterhen system, but data is limited at this time.

In May, 1970, tagging done at Duck Bay on Lake Winnipegosis produced 763 recoveries, none of which were recovered in any part of the Waterhen system or Lake Manitoba. Although this and other studies indicate limited downstream walleye movement out of Lake Winnipegosis, further tagging studies on Lake Winnipegosis are required.

Open water angling in the Waterhen area in most years is usually fairly good for most of the summer. Although walleyes usually leave their spawning stream and return to the main body of water within six weeks of spawning (Eschmeyer, 1950) walleye feeding movements have been related to early summer minnow spawning runs (Dickson, 1963). The Waterhen River system has deep water sections suitable for summer habitation.

A cursory review of Lake Waterhen winter fish production indicates a positive correlation exists with mean Waterhen River discharges. This could mean walleyes are attracted out of Lake Winnipegosis and into Lake Waterhen under high flow conditions or increased flows attract downstream walleye stocks, which remain for a prolonged period in the Waterhen and Lake Winnipegosis area. If this should happen, large upstream walleye runs into Lake Winnipegosis may be sufficient to suddenly modify existing year class structures in the south end of Lake Winnipegosis.

Winter walleye abundance is usually low in the Waterhen River areas. In low flow winters, anoxic conditions occasionally

develop in the Waterhen rivers forcing fish back to the major lakes or result in winterkill. Low winter dissolved oxygen levels did not occur in 1971-72.

In conclusion, superficial observations of seasonal walleye movements (as well as most other species) indicate a preponderance of downstream migration. However, the same results could be expected if a sizeable portion of the upstream run was missed or if fish movement from the West Waterhen River to the Little Waterhen River is extensive. The Waterhen River system is a prime spawning area for Lake Manitoba walleyes whereas few walleyes from Lake Winnipegosis would move down into the Waterhen River to spawn. The recapture rate of tagged walleyes on Lake Manitoba should be several times greater than on Lake Winnipegosis, yet recapture rates for the two lakes are fairly similar. This, plus other tagging studies, would suggest a conflicting conclusion. That is, fish stocks on the Waterhen River system and Lake Winnipegosis may periodically benefit in those years in which relatively high continuous flows attract and maintain fish stocks, originating from Lake Manitoba and Lake Waterhen, for a longer period in the Waterhen River complex and Lake Winnipegosis. Significant fish losses out of Lake Winnipegosis remain a possibility but further tagging, especially in the Long Island Bay area, is required.

ACKNOWLEDGEMENTS

We **would** like to express thanks to Mr. T. Smith and R. Thomas who conducted most of the trapping and tagging. We also thank I. Orvis who supervised the winter installation of the trap nets. Mr. H. Valiant contributed toward data analysis and editing of the final report.

LITERATURE CITED

- Anonymous. 1976. Pickerel Movements and the Fairford Dam. Lake Winnipegosis issues and information. Manitoba Dept. of Renewable Resources and Transportation Services, 24 pp.
- Bailey, Reeve M., 1970. A list of common and scientific names of fishes from the United States and Canada. Third Edition. American Fisheries Society. Special Publication No. 6, 149 pp.
- Dickson, I. 1963. Preliminary report on a pickerel spawning investigation, Red Deer River, May, 1963. Manitoba Dept. of Mines and Natural Resources Fish Branch, MS Report.
- Eschmeyer, R.H., 1950. The life history of the walleye Stizostedion vitreum vitreum (Mitchill) in Michigan. Mich. Dept. Conserv., Bull. Inst. Fish Res., No. 3, 99 pp.
- Hewson, L.C., 1955. Age, maturity, spawning and food of burbot, Lota lota in Lake Winnipeg. J. Fish. Res. Bd., Canada, 12 (6), 930-940.
- Scott, W.B. and E.J. Crossman. 1973. Freshwater fishes of Canada. Bulletin 184. Fish. Res. Bd., Canada. 966 pp.